

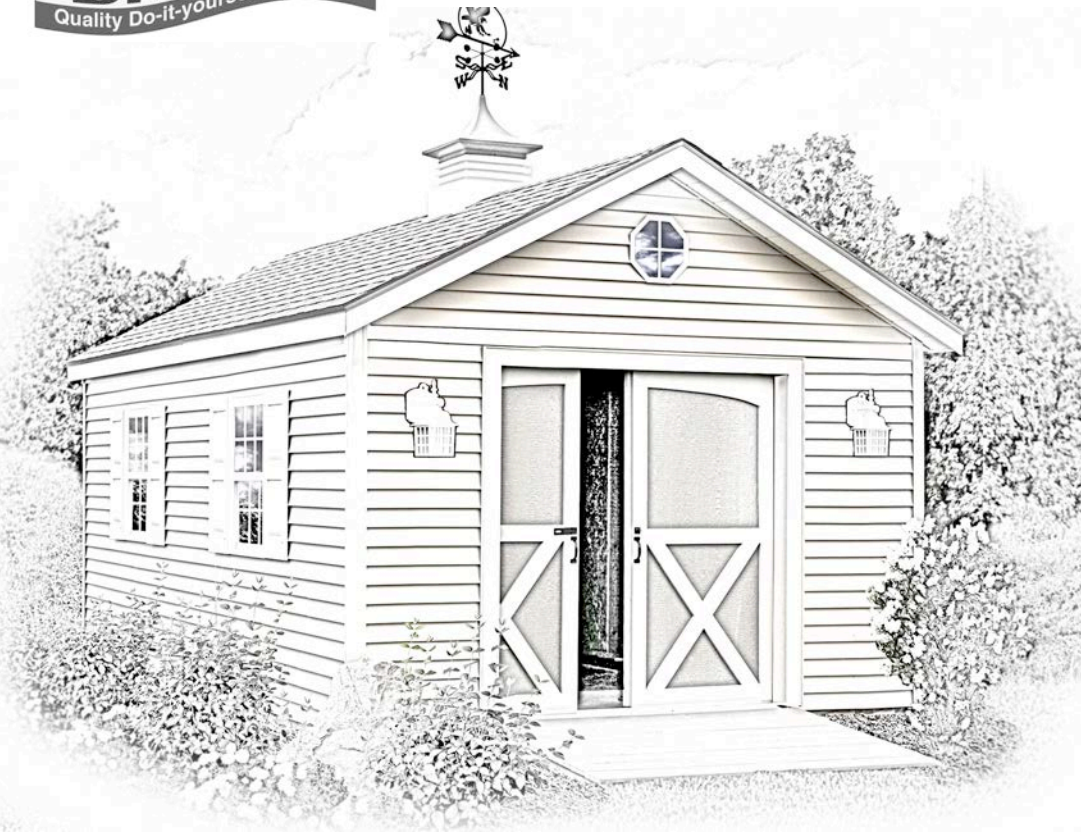

Assembly Book

Revised June 19, 2019



South Dakota II

Building Size 12'x16'

Manufactured by Reynolds Building Systems, Inc.

205 Arlington Drive

Greenville, PA 16125

800-245-1577

This manual is copyrighted. Under the copyright laws, this manual may not be copied, in whole or in part, without consent from Reynolds Building Systems, Inc. © Copyright 2018

IMPORTANT INFORMATION ABOUT YOUR KIT

Thank you for purchasing our kit. Please read the following information before beginning construction. Always check with your local HOA or building code office for any requirements or restrictions.

Floor: Wood flooring is sold optionally. You may choose to build your own or pour a cement pad.

Always wear safety glasses when cutting or nailing!

Tools Required:	Hand or Circular Saw	Level	Safety Glasses
	Cordless Drill	Measuring Tape	Dust Mask
	Hammer	6'-8' Ladder(s)	Phillips Screwdriver
	Pencil		Framing Square

Additional Materials - **Not included in kit:**

Windows and Walk-in Door are purchased separately

Required: Shingles or metal roofing, Drip Edge, Roofing Nails or Screws, Paint, Vinyl Siding

Optional: Caulk, Ridge Vent

Terminology:

Square - Confirming corners are 90 degrees

Plumb - Confirming walls, gables and trusses are straight vertically

Wall Plate - Top and bottom 2x4s used to frame walls

Tie Plate - Second layer of 2x4s connecting wall sections together

Header - Spans top of door opening

OSB - Oriented Strand Board

Organize:

Unpack all items & organize according to size and type. This will make items easier to find when instructed.

Review the parts list on the back page. Should there be missing items or sub-par material contact Best Barns Customer Service.

DO NOT discard any material including the pallet until your project is complete.

Assembly:

Review all instructions before you begin. Please follow steps carefully and in sequence for successful results.

If you have any questions we are happy to assist you. Please contact us at:

800-245-1577 - Mon - Fri 8AM - 5PM EST

724-866-4357 - After hours and weekends

Email - questions@barnkits.com

Optional Wood Floor System

Foundation size is 12'-0" x 16'-0". Check local building codes in your area, the construction may have to change. For a concrete slab, install sill sealer as a moisture barrier between the concrete and the wall plates. Foam sill sealer can be purchased at home centers in rolls 3-1/2" or wider.

1. Cut (2) two 2x4-8' boards into 2' long blocks. Butt the 4x4-8' timbers together to make 16' runners. Secure the 4x4s together with the 2' long 2x4 blocks and 16d galvanized nails.
2. Cut (2) two 2x4 joist headers to 16' - 0". Layout for 16" on center joist spacing. 'X' marks where floor joist will be placed.

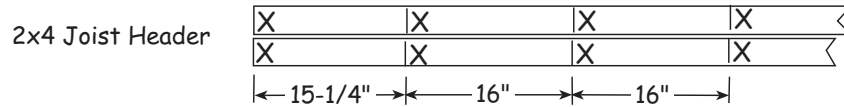

3. Cut 2x4-12' floor joist to 11'-9". *Treated lumber may be thicker than 1-1/2". Take this into account when cutting the length of floor joists. Shorten joist measurements if necessary to obtain 12'-0" building width.*

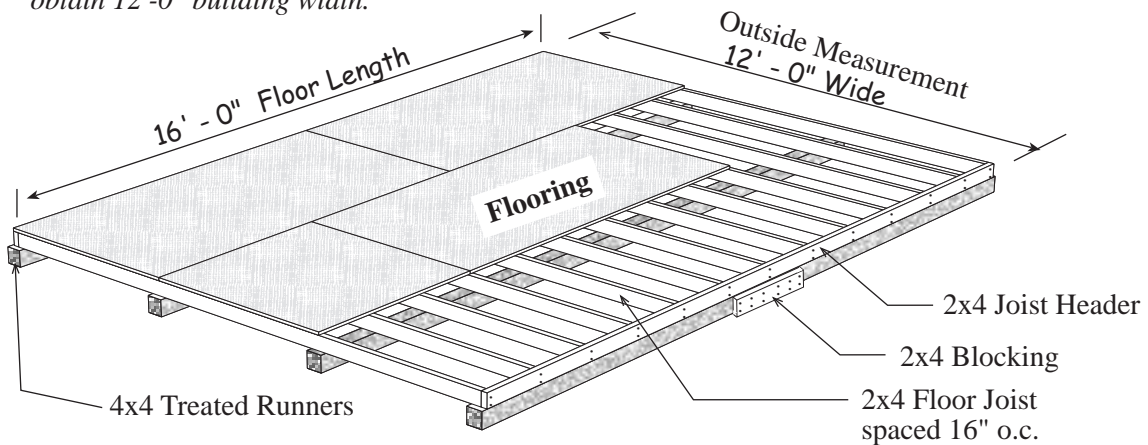

It is important that the floor be level and square. Square the floor as follows: before nailing the flooring, measure the floor diagonally (corner to corner). Then measure the opposite corners; these measurements will be the same when the floor is square. Toenail frame to the 4x4 runners.

Install the flooring with 8d galvanized nails spaced 8" apart.

Material Description	Qty. & Size
2x4 Treated Blocking	2 pcs. 8'
2x4 Treated Floor Joists	13 pcs. 12'
2x4 Treated Joist Headers	2 pcs. 16'
4x4 Treated Runners	8 pcs. 8'
Flooring: 5/8" or 3/4"	6 pcs. 4x8
Galv. Spiral Floor Nails	3 lbs. 8d
Galvanized Deck Nails	3 lbs. 16d

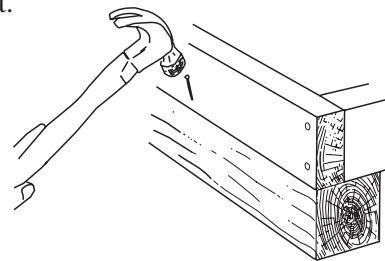

Nail 2x4 joist headers and floor joist to 4x4 runners.

Step 1 Assemble Sidewalls

 **Do not discard any material until construction is complete, including short 2x4 blocks.**

1. Cut (2) two 2x4-16' to a length of 185". Position the boards together and indicate with 'X' marks where the wall studs will be located.

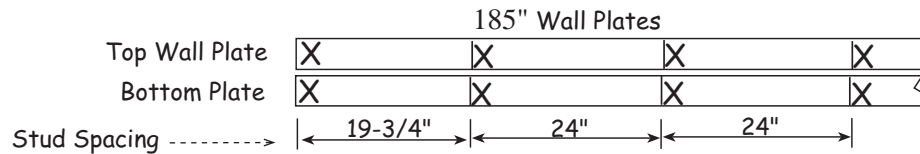

2. Install (9) nine pre-cut wall studs between the top & bottom plates with (2) two 10d sinkers on each end.

 *The length of pre-cut studs will vary from 92-1/4" to 93" depending on what part of the county you are located.*

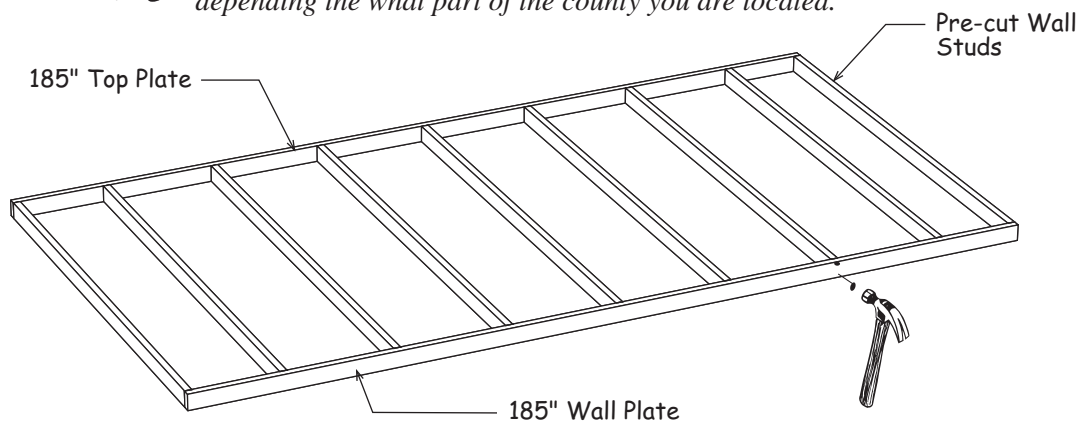

3. Repeat to assemble another 185" long wall frame.
4. Set frames aside.

Step 2 Assemble Door Header

1. Locate (2) two 2x8-8' boards. Cut these boards to a length of 75".
2. Assemble the door header using 2x8 boards and (2) two 7-1/4" x 48" OSB filler included in our kit. Apply wood glue to both sides of OSB and install (1) one filler to one end. Cut to fit second OSB filler. Nail together with (12) twelve 10d sinkers spaced evenly on each side.

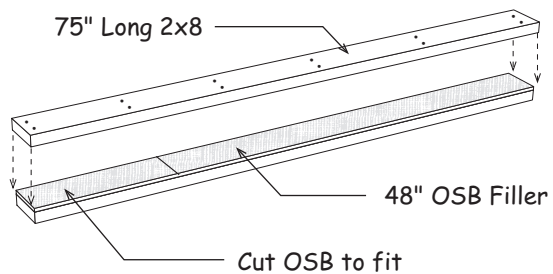

Step 3 Assemble 12' Back Wall

1. Cut (2) two 2x4-12' to a length of 144". Position the boards together and indicate with 'X' marks where the wall studs will be located.

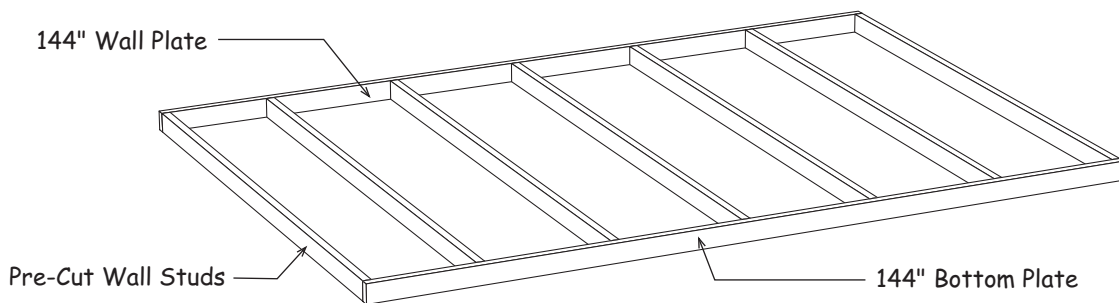
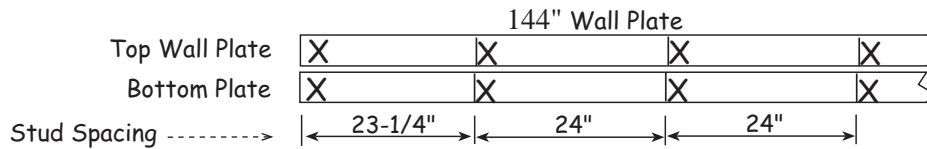

2. Install (7) seven pre-cut wall studs between the top & bottom plates. Nail top and bottom plates to studs using 10d sinkers.
3. Square wall frame. Measure the wall diagonally (corner to corner). Then measure the opposite corners. These measurements will be the same if the wall is square.
4. Install the first 7/16" Oriented Strand Board (OSB) panel flush with the side of the wall stud and flush with the top 2x4 plate. Nail siding with 6d common nails, spaced 8" apart. Cut the OSB flush with the 2x4 bottom plate if you are installing the building on a concrete slab.
5. Install (2) two more OSB panels.

 Depending on length of pre-cut studs siding may extend below bottom plate.

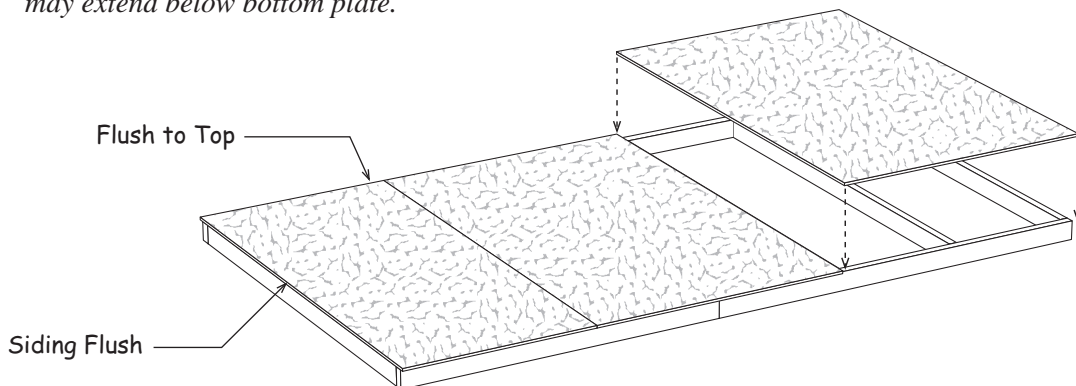

Step 4 Assemble Front Wall Frame

1. Cut (2) two 2x4-12' boards to a length of 144" for wall plates. Position the boards together and indicate with 'X' Marks where the wall studs will be located.

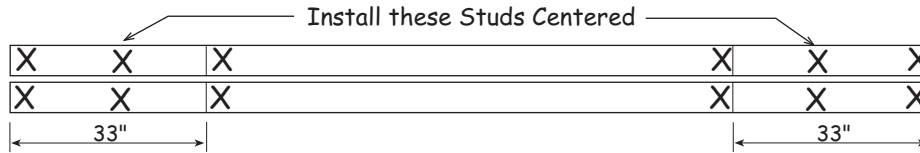

2. Install (6) six pre-cut wall studs between the wall plates where shown.

3. Remove (2) two 2x4s screwed to the pallet. Cut both to a length of 78-1/2" and install as header supports where shown. Nail to studs with 10d sinkers.

4. Install the door header on the 2x4 header supports. Nail to the stud with 10d sinkers.

5. Measure space between header and top plate. Cut (4) four pieces to this length from a pre-cut stud. Equally space the (2) center blocks. Nail through top plate and toenail to header. Use 10d sinkers.

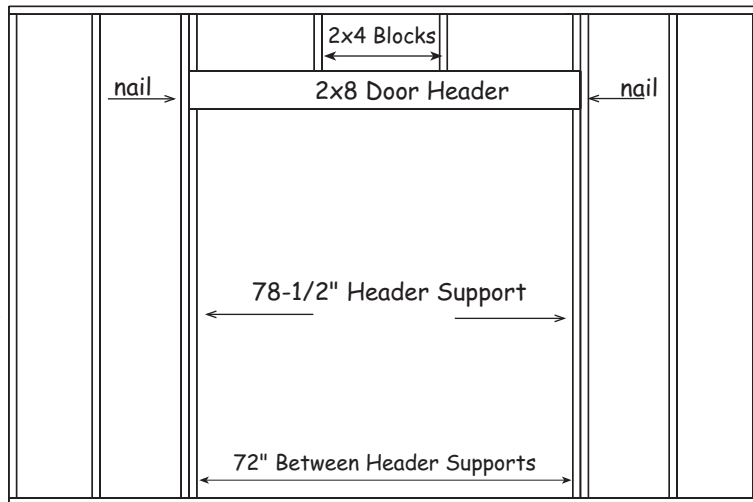

6. Install a OSB panel flush with left side of wall frame. Before installing OSB, cut the OSB flush with the side of the door opening and the top 2x4 plate.
7. Cut to fit and install a 20"x48" OSB panel above the door opening. Cut OSB flush with the bottom of the door header.
8. Install a OSB panel on the right side of the wall panel. Cut OSB as previously instructed.

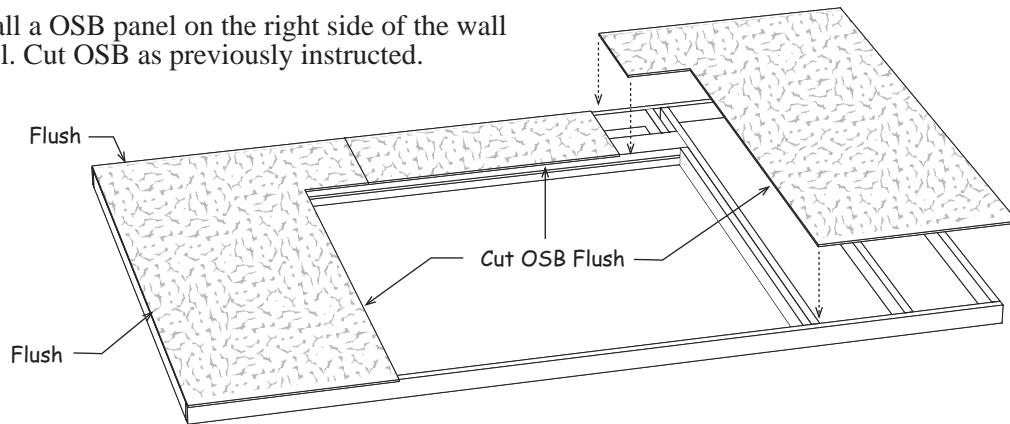

Step 5 Set Wall Panels

1. Erect back wall and side walls. Secure walls together at the corners. Use (4) four 10d sinkers per corner. Brace side walls with pre-cut wall studs to hold walls secure and plumb.
2. Starting at back corner install a OSB panel flush with the OSB on back wall and flush with top plate. Nail OSB to back wall and all 2x4s using 6d common nails spaced 8" apart
3. Install (3) three more OSB panels. Last panel will extend 3-1/2" past wall to receive front wall panel.
4. Start at back wall and apply OSB to opposite wall.
5. Erect front wall panel and secure corners with 10d sinkers. Nail OSB to front wall.
6. Cut and remove bottom 2x4 from door opening.
7. Nail walls to floor through bottom plate. Space 10d sinker nails 24" apart.

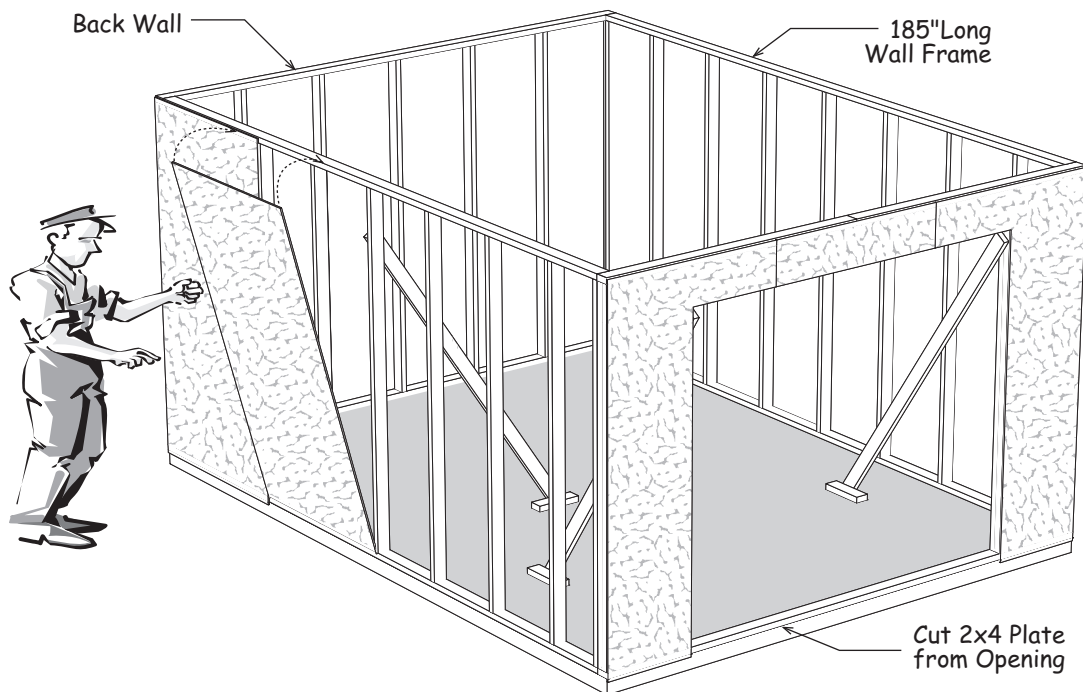

Step 6 Assemble Roof Gables

1. Cut (2) two 2x4-12' boards to a length of 144".
2. Place one of the 144" boards on the floor along with (2) two 80-1/2" long 2x4 rafters as shown below. Bottom 144" plate will be on edge. Rafters will lay flat.



There are short 2x4s, that may have an angle on one end, supplied in the kit. Use these to hold the rafters and bottom gable plate together by temporarily screwing the blocks to the floor using 2-1/2" screws. This will ensure that the gable frames and the trusses are identical.

3. Secure the top of the rafters together with a 1"x4" barbed metal drive-on plate.
4. Install (2) two 23-1/2" gable studs with angle cut at one end. Nail through the bottom plate with 10d sinkers and secure the top with barbed metal drive-on plates.

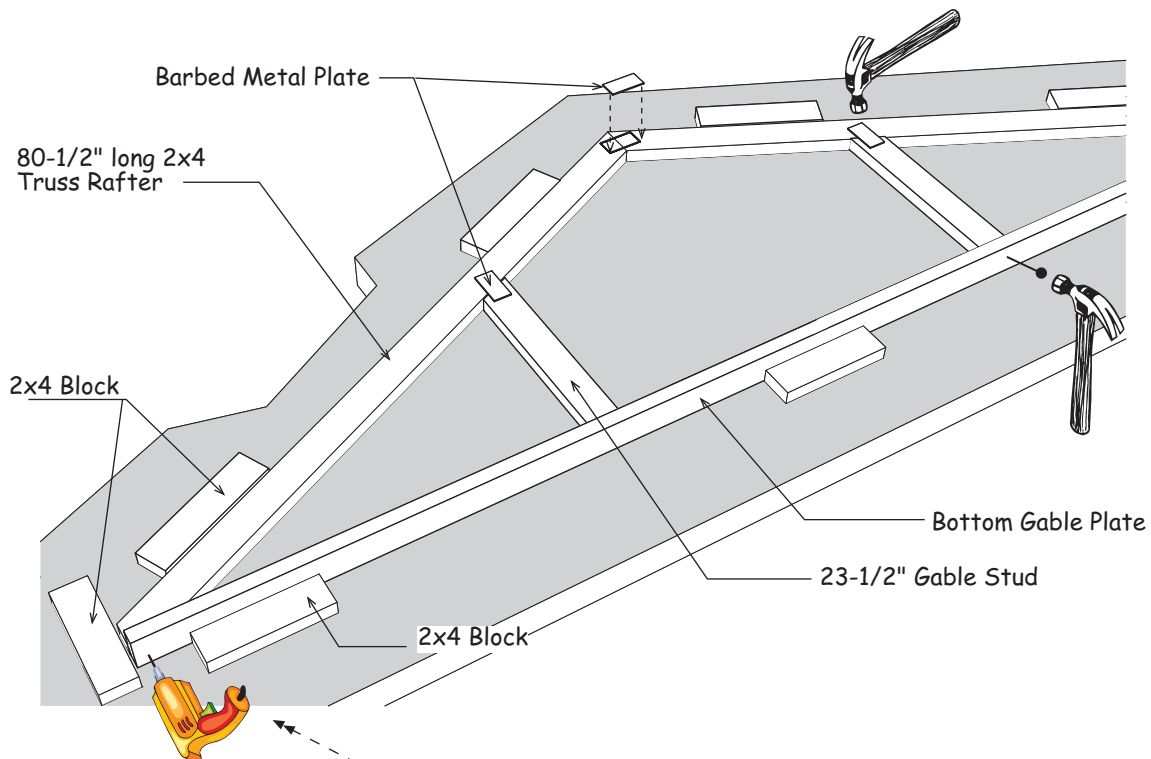

5. Secure the 2x4 bottom plate to the truss rafter with a 2-1/2" wood screw on both ends. Set gable aside.
6. Repeat steps to assemble another gable.

Step 7 Assemble Roof Trusses

1. Place (2) two 80-1/2" long 2x4 truss rafters and a 82" long collar tie together as shown below. The collar tie has an angle cut on both ends. Insure the collar tie ends are at equal distances from truss top. Reposition the lower 2x4 blocks to hold the truss rafter and collar tie in place. See **'Detail B'**.
2. Secure the 2x4 truss rafters at the top with a 8" x 20" wood gusset. Apply wood glue between the 2x4s and the gusset. Nail the gusset to the 2x4s with (14) fourteen 6d common nails,
3. Install (2) two 12"x24" gussets at ends of the collar tie. Glue and nail using 14 nails per gusset.
4. Turn this truss over and apply wood gussets to the opposite side.
5. Repeat to assemble (6) six more trusses.

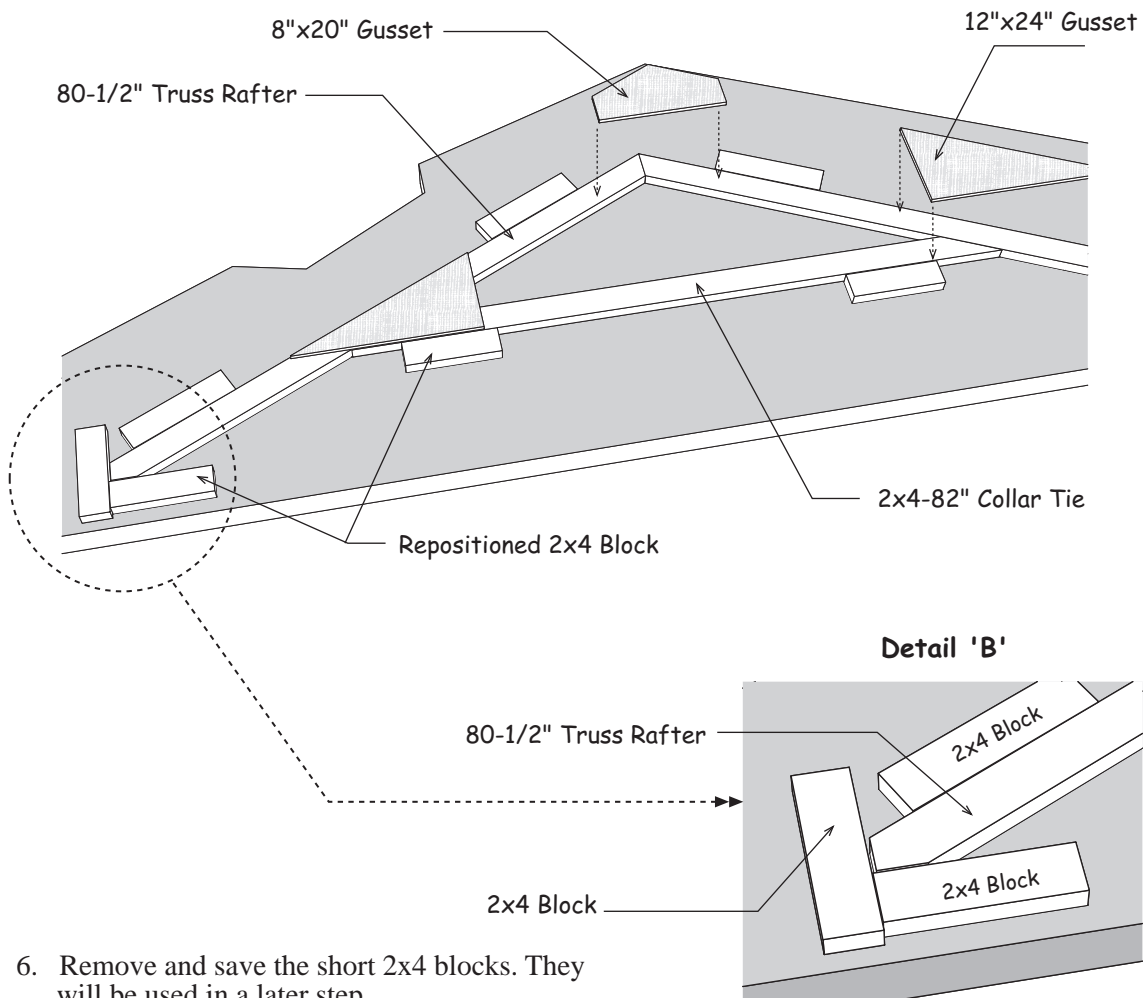

Step 8 Install Primed Soffit and Fillers

1. Install a 7" wide x 48-3/4" siding panel over the side wall with the primed side facing down. The 'tongue' edge should be flush with front wall plate, NOT over OSB. Tack the soffit with a couple 6d common nails. Installing 2x4 tie plates in a later step will provide more nailing.
2. Install (3) three more siding panels. Cut the last soffit flush with the 2x4 wall plate.

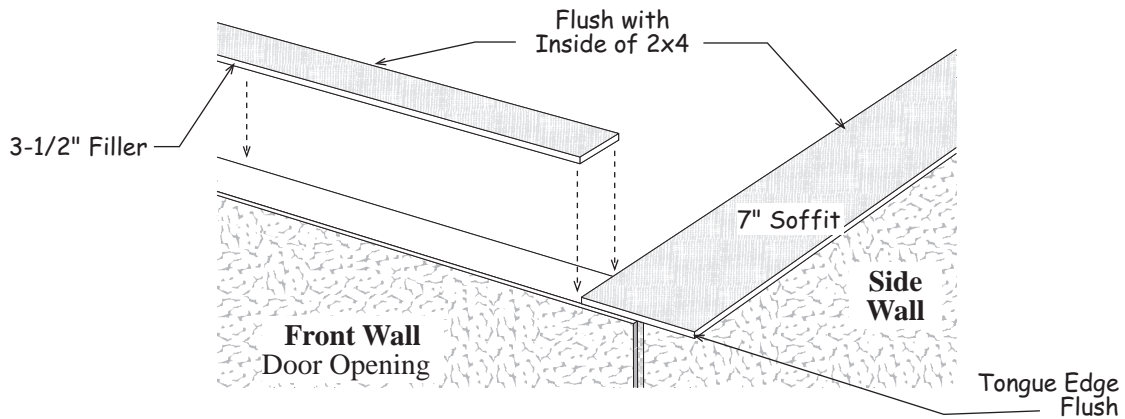

4. Repeat to install soffit on the opposite side wall.
5. Install (3) three 3-1/2" wide x 48-3/4" filler panels over the front and back wall. Cut the last filler to fit between the soffit on the sidewalls.

Step 9 Install Roof Gables

1. Install a gable frame centered on the back wall. Gable plate should be flush with filler. NOT over OSB. Secure with 10d sinkers.
2. Install the gable frame on the front wall.

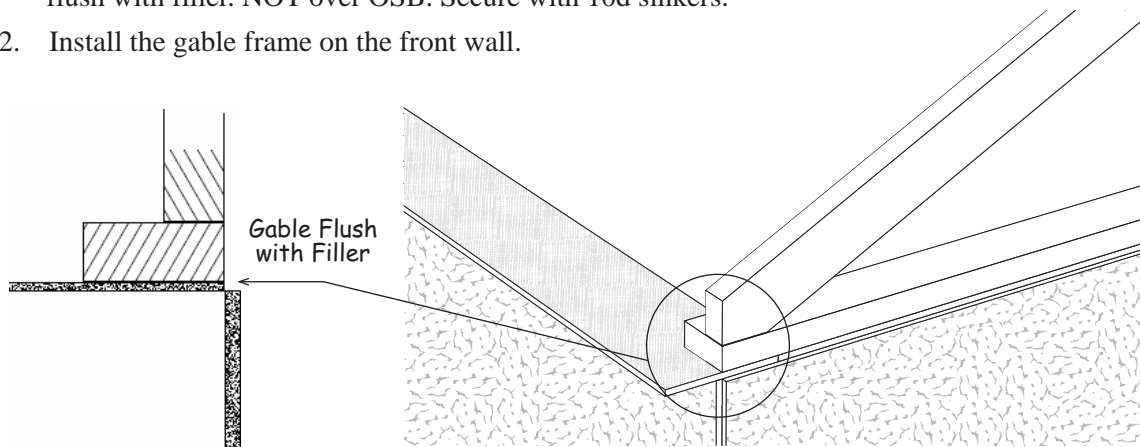

Step 10 Install Siding on Gables

1. Locate pre-cut gable OSB. Install OSB above the lower OSB wall panels and flush with ends of gable frame. Use 6d common nails.
2. Repeat to install siding on the other gable frame.

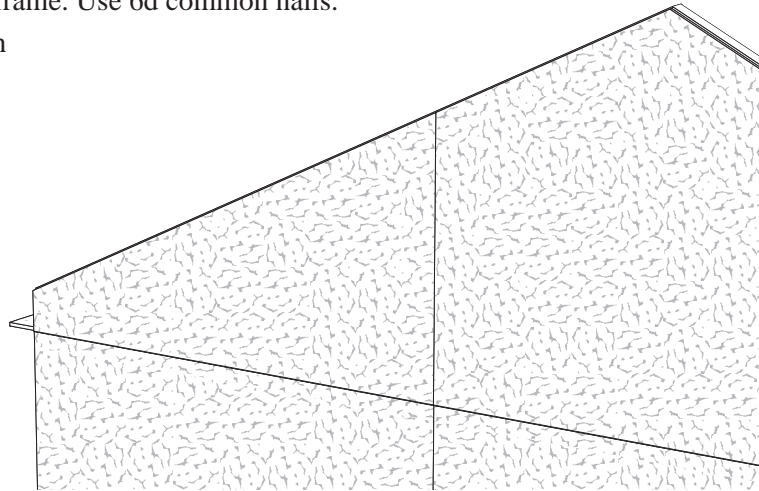

Step 11 Install 2x4 Tie Plates on Side Walls

1. Cut a 2x4-16' board to fit between the gables on the front and back wall. Install the 2x4s flush with the inside of soffit. Use 10d sinkers.
2. Repeat to install tie plates on the opposite side wall.

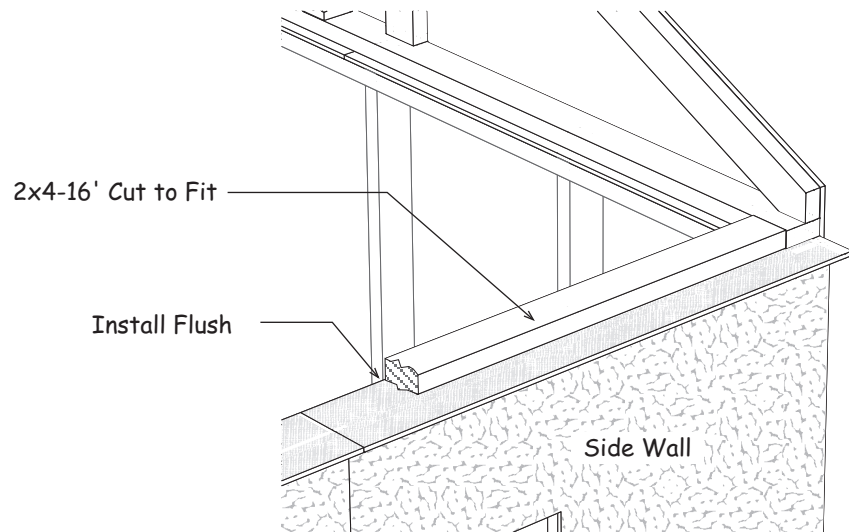

Step 12 Layout Roof Trusses & Install Soffit Blocks

1. Starting on back corner measure from the backside of the 2x4 gable frame when marking the location of the first truss. Continue 24" spacing to other gable. **Important:** When marking the opposite wall, place the 'X' mark on the same side of the line so your trusses are parallel when they are installed.
2. Install metal hangers to the tie plate with 1-1/2" hanger nails. The opening should line up with the 'X' mark, the bottom of the opening, flush with the 2x4 tie plate. **Detail 'D'**.

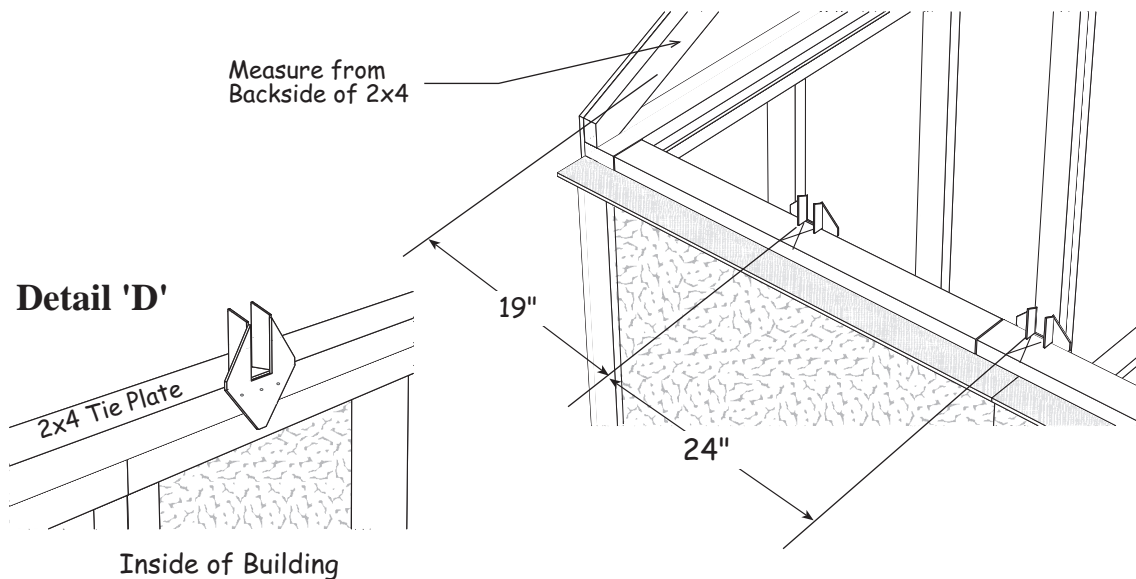

3. Set roof trusses. Secure trusses to metal hangers with 1-1/2" hanger nails.
4. Gather (14) fourteen short 2x4 blocks and install one at both ends of each truss. Secure 2x4 blocks to the soffit panel using (2) two 1-1/2" long exterior screws.
5. Gather (4) four more 2x4 blocks. Install one 2x4 block at each end of the soffit, flush with the 2x4 gable frame.

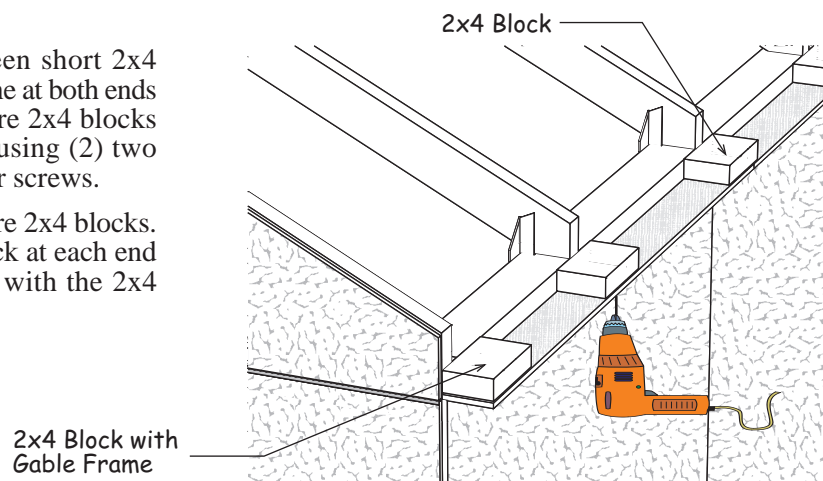

Step 13 Install Rear Gable Trim

 **The front gable trim will be installed in a later step.**

- 1 Install (4) four small OSB fillers, *packed with the hardware*, over the 2x4 soffit blocks. Fillers will be flush with the gable OSB. Use 6d common nails.

OSB Filler

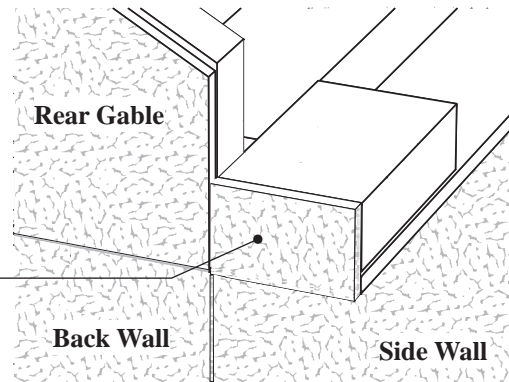

2. Install (4) four 42-3/8" long 2x3 boards on the rear gable flush with the top of the gable frame. Use 10d sinkers

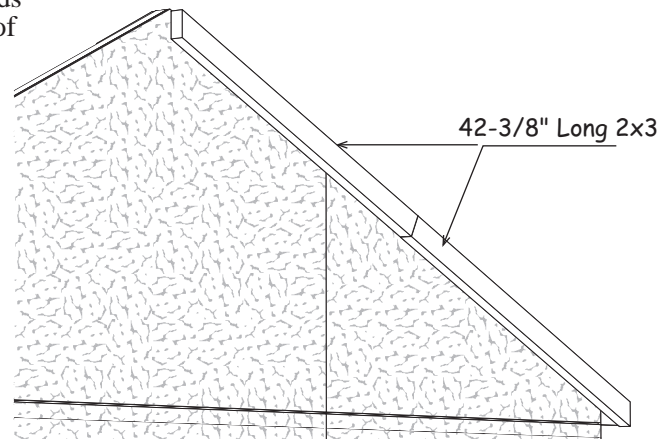

3. Install a 8-1/2" long trim board, *called a keystone*, at the top of the gable flush with the top of the gable frame. Use 6d galv. nails.

Keystone

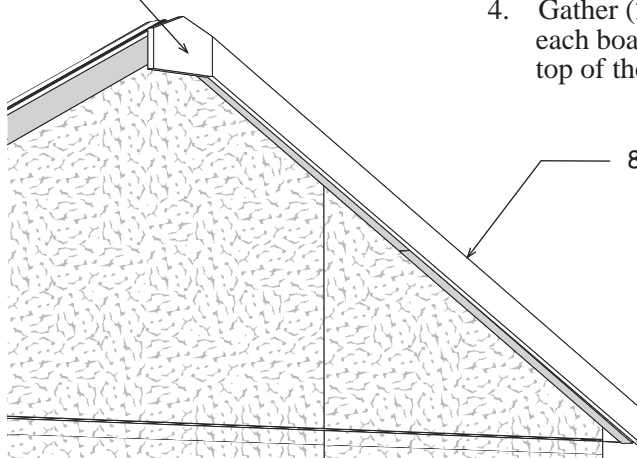

4. Gather (2) two 82-1/2" long 1x4 trim boards. Butt each board against the keystone and flush with the top of the gable frame. Use 6d galv. nails.

82-1/2" Long 1x4 Trim

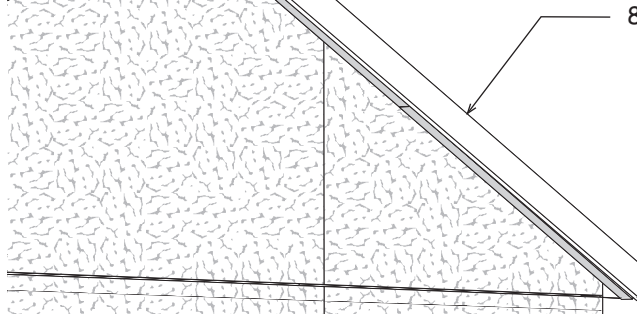

Step 14 Install Fascia on Side Walls

1. Install a 1x4-6' white pine fascia board against the rear gable trim. Install the fascia so the bottom edge of the roof sheathing will rest on the edge of the 1x4. **See Detail 'E'**. Use a straight edge to align the 1x4 board with the top of the trusses. Use 6d galv. nails.
2. Install another 6' fascia board. Do not install the last fascia board. This will be applied after the front overhang is installed.
3. Repeat on opposite side wall.

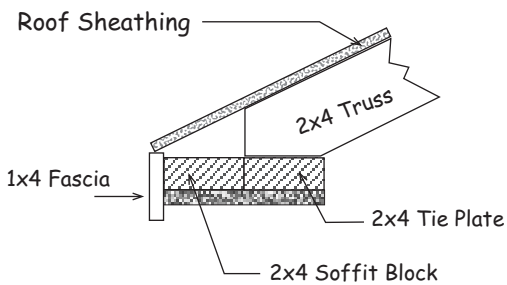

Detail 'E'

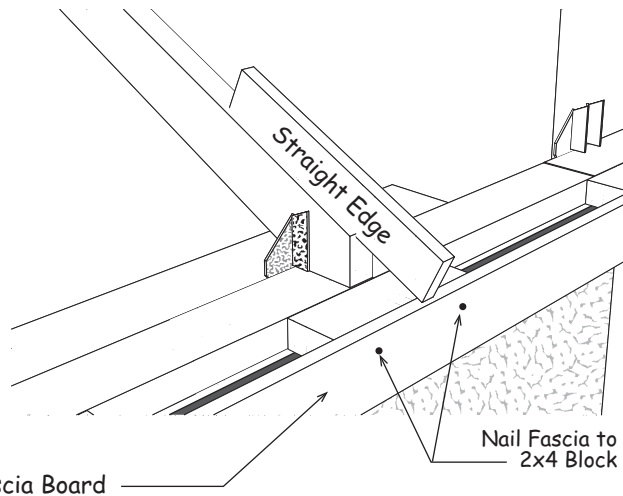

Step 15A Install Roof Sheathing

1. Install (4) four 42-3/8" long 2x3 boards on the front gable flush with the top of the gable frame. Use 10d sinkers
2. Plumb each truss and gables.
3. Refer to sheathing layout at the top of the next page. Install roof sheathing starting at the front gables lower corner. The roof sheathing should extend 6-1/4" beyond the 2x3s. Continue to back wall. Use 6d common spaced 8" apart. The top row of roof sheathing will be about 1" below the ridge to allow for optional ventilation.

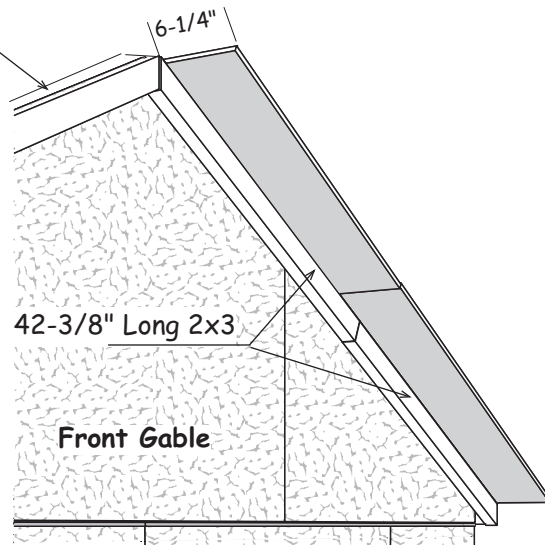
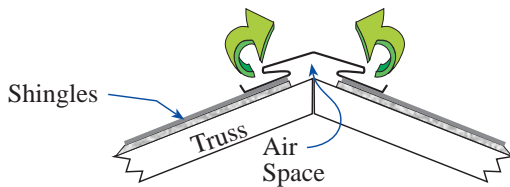

Step 15B Install Roof Sheathing continued

 *Sheets should meet at center of trusses when installed*

- From 4x8 sheets of OSB cut to the sizes indicated with an * below. Repeat for opposite side.

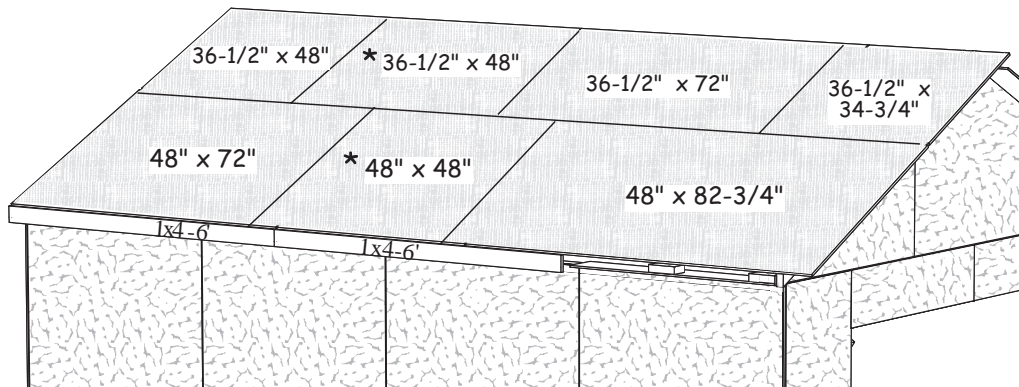

- Trim off any sheathing that extends over the rear gable trim.

Step 16 Install Front Soffit

- Gather (2) two 7" wide soffit panels. Install first panel flush with lower end of 2x3 and against siding. Install with 1-1/2" exterior screws. Cut upper panel to fit.
- Install (2) two 42-3/8" long 2x3s between the roof sheathing and the 7" soffit panels. Install with 1-1/2" exterior screws on soffit and 6d common through roof sheathing. Set these boards flush with soffit panels. The roof sheathing will extend 3/4" past the 2x3s to allow for trim.

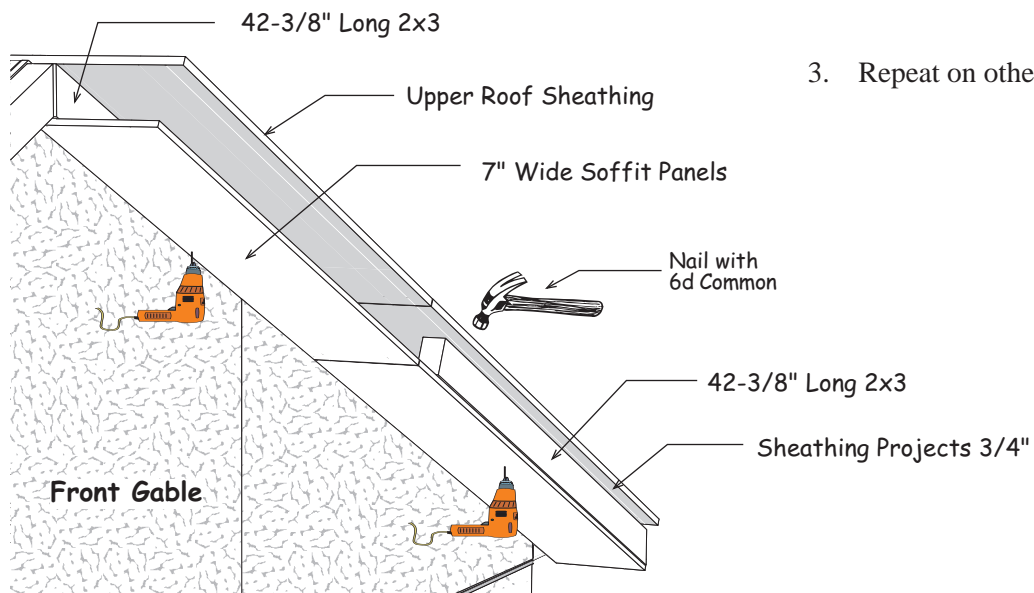

- Repeat on other side.

Step 17 Install Door Flashing

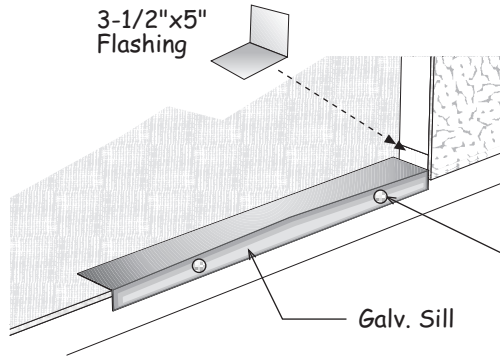

1. Locate in the pocket door box (2) two 3-1/2" x 5" metal flashing and bend along width to 90 degrees. Install at each corner of the door opening. These will be covered in the next steps.
2. Install the galv. door sill over flashing in the center of the door opening. Use 1-1/4" pan head screws along the front edge.

Step 18 Install Gable & Door Trim

1. Install a keystone and gable trim under the roof sheathing as done in **Step 13**.
2. Install a 3-7/8" x 72" primed jamb material on the top of the door opening, flush with the front wall OSB. Use 6d galv. nails.
3. Locate (2) two 3-7/8" x 79-5/8" primed jamb material and install on the sides of the door opening, flush with the front wall siding.
4. Measure from bottom of header to bottom of siding. Cut (2) two 84" long 1x4s to this length and install on sides of door opening flush with bottom of header and door jamb.
5. Locate an 81-3/4" long 1x4 trim board, *this board has angle cuts on both ends*. Cut this board to fit flush with outside of vertical door trim. Install above door.

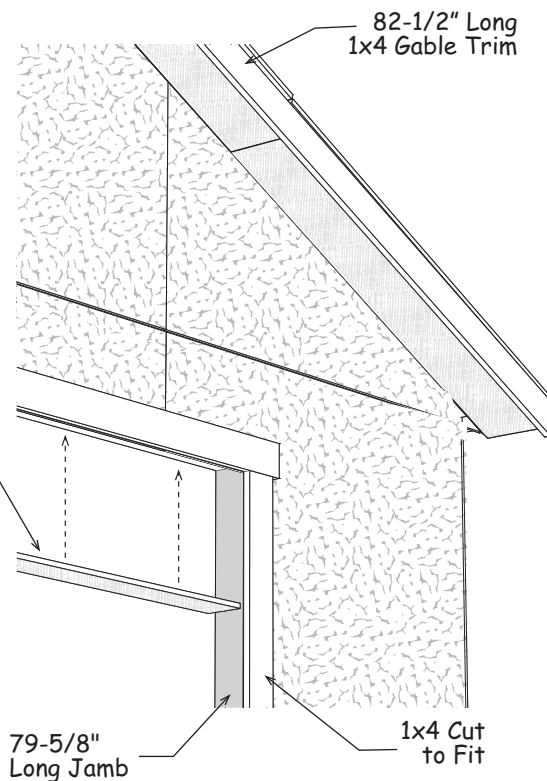

Step 19 Finish Side Wall Trim

1. Locate (2) two 1x4-6' trim boards. Cut each to fit against back of front gable trim and install on the side walls.

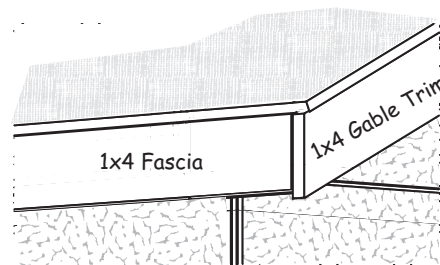

Step 20 Install Pocket Doors Track

1. Install a 68-1/2" long Track Support Assembly 82-3/4" from the floor. **Important:** measure from the bottom of the 2x3 on the support assembly to the floor. Insure the notched end of track is center of door opening. Use 2-1/2" screws.

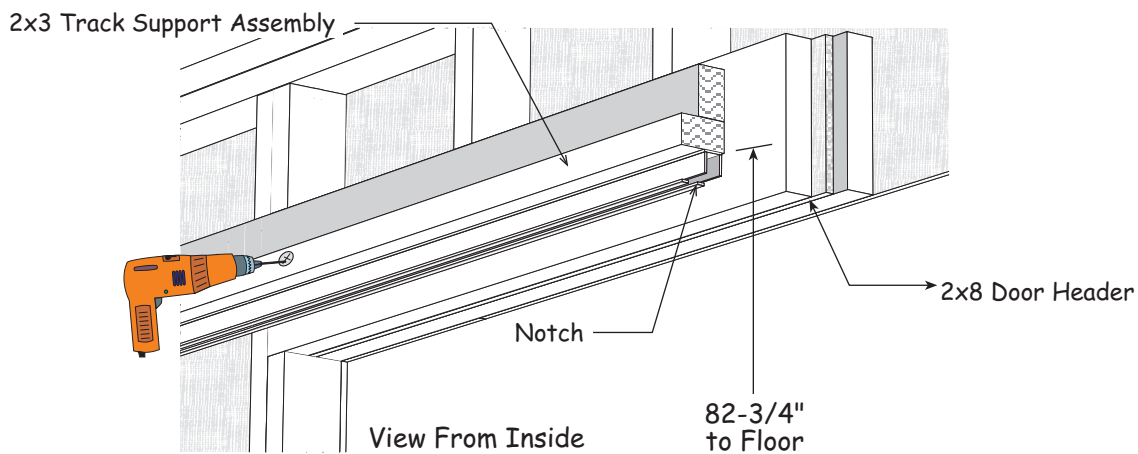

2. Install the other track support assembly.

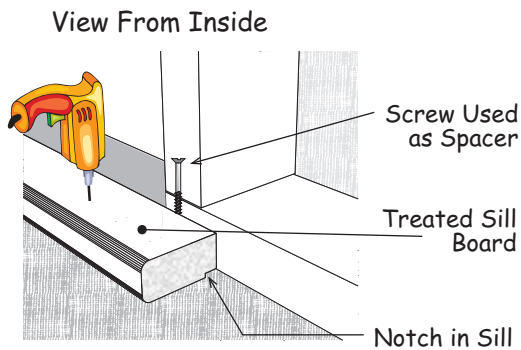
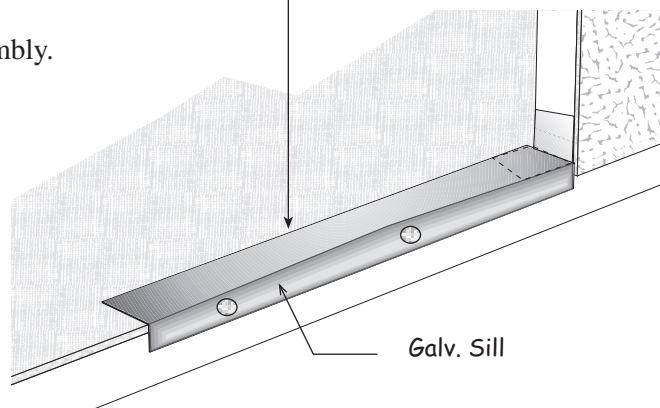

5. Install the treated door sill behind the door opening. There needs to be a space between the treated sill and the inside wall. To position the sill, insert a 2-1/2" screw between the treated sill and the inside wall as a spacer. Screw the sill to the floor with (6) six 2-1/2" long screws. Remove the screw used as a spacer.

 *Building Tip; run a bead of caulking where flashing, treated sill and aluminum sill meet to prevent moisture from penetrating.*

Step 21A Install Doors

1. Select the door with the siding and trim board extending past the 2x4 frame, *see detail below*. Standing on the inside of building slide the rollers on the left side track as shown below.

If it is necessary to adjust the door height one or both door carriers can be adjusted. Loosen screws that secure carrier(s) to the door. Adjust door so the aluminum angle, on the bottom of the door, does not rub on the treated threshold. Tighten the screws.

Tip: Inserting a screw, *shown below*, will prevent the doors from falling through the opening between the track, if the door is opened too far.

IMPORTANT:

DO NOT install both track rollers in the space between the Track Legs.

Install the track rollers on either side of the inside track leg.

See detail below.

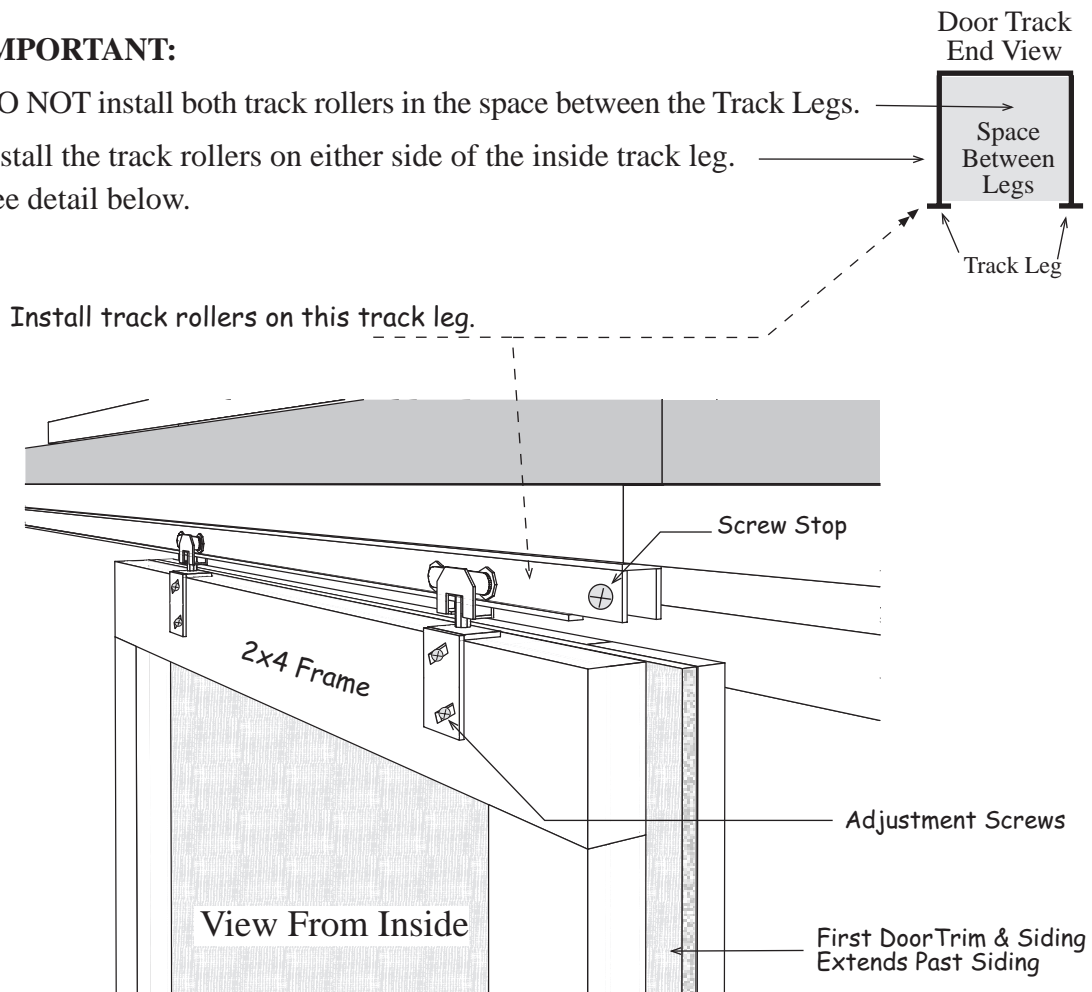

Step 21B Install Doors continued

1. Hang the other door. On this door, install a sliding door latch, on the lower back of the door to secure this door in place when closed. You will need to drill a hole in the floor for the round shaft to drop into.
2. Install a metal plate to the bottom of the right door. The angle end will hold the bottom in-line with the left door when closed.
3. Install the door handles and locking door hasp on the outside of the doors. When installed properly the hasp will fold in half to receive locking latch and screw heads will be covered.

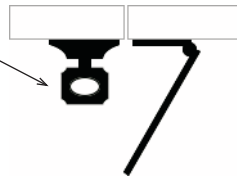
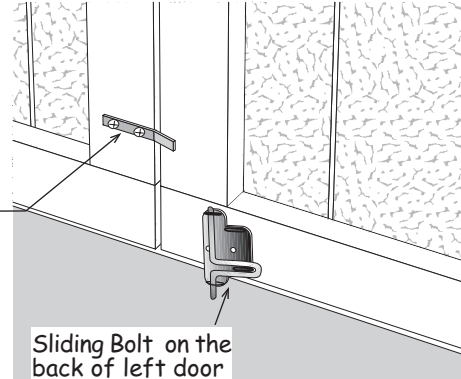

Material List for Wood Pocket Doors

2	36" x 79" Wood Doors w/ Primed Siding	4	Track Rollers with Brackets
2	Boards w/ Alum. Track Attached	1	Swivel Door Latch
1	Treated Wood Threshold	2	Door Handles
1	Galvanized Door Sill	1	Sliding Latch
1	Door Trim 1x4 81-3/4"	1	Flat Steel Bar Door Guide
2	Door Trim 1x4 80"	2	3" x 5" Galv Flashing
1	Door Jamb 3-7/8" x 72"	4	1-1/4" Pan Head Screws for Door Sill
2	Door Jamb 3-7/8" x 79 - 5/8"	16	2-1/2" Wood Screws / square bit

Required Shingles

10 bdl.	Roof Shingles
8 pcs.	Roof 'drip' Edge-10'

Material List for Vinyl Siding - Not Included

4-1/2 sq.	Vinyl Siding	<i>double 4" standard profile</i>
4 ea.	Outside Corners	
5 ea.	J-Channel	
3 ea.	Under Sill Trim	
4 ea.	Starter Strips	
2 lb.	Nails	

South Dakota 12x16 Material List

7	2x4 for Collar Ties	82"	14 ea.	Gussets	7/16"	10" x 24"
18	2x4 for Truss Rafters	80-1/2"	28 ea.	Gussets	7/16"	12" x 24"
4	2x4 for Gable Studs	23-1/2"	1 ea.	Sheathing	7/16"	20" x 48"
18	2x4 for Soffit Blocks	5" or longer	2 ea.	Sheathing	7/16"	48" x 40" <i>angled</i>
6	1x4 for Sidewall Fascia	72"	4 ea.	Sheathing	7/16"	48" x 28" <i>angled</i>
4	1x4 for Gable Trim	82-1/2"	2 ea.	Sheathing	7/16"	48" x 82-3/4"
12	2x3 for Gable Overhang	42-3/8"	2 ea.	Sheathing	7/16"	48" x 72"
12	ea. Soffit Panels	48" x 7"	2 ea.	Sheathing	7/16"	36-1/2" x 72"
6	ea. Soffit Fillers	48" x 3-1/2"	2 ea.	Sheathing	7/16"	36-1/2" x 48"
4	lbs. 10d Sinkers		2 ea.	Sheathing	7/16"	36-1/2" x 34-3/4"
1	lbs. 6d Galv. Nails		4 ea.	OSB Fillers	7/16"	2" x 3-1/2"
12	lbs. 6d Common Nails		2 ea.	Header Filler	7/16"	7-1/4" x 48"
2	lbs. Hanger Nails		<i>Additional material not used in this model</i>			
100	ea. 1-1/2" Exterior Screws		2 ea.	Door Jamb	3/8"	5-3/8" x 48"
25	ea. 2-1/2" Deck Screws		2 ea.	Door Jamb	3/8"	5-3/8" x 84"
6	ea. 1"x4" Metal Plates		1 ea.	Sheathing	7/16"	20" x 48"
14	ea. H1 Metal Truss Hangers		4 ea.	Soffit Panels	3/8"	48" x 7"
2	ea. Bottle Glue		8 ea.	Gussets	7/16"	10" x 24"
2	ea. 1x6 Keystone 8-1/2"		16 ea.	Gussets	7/16"	12" x 24"

Qty.	Material Supplied by Local Supplier	
35 pcs.	2x4	Pre-cut Wall Studs
6 pcs.	2x4 - 12'	Wall & Tie Plates
6 pcs.	2x4 - 16'	Wall & Tie Plates
2 pcs.	2x8 - 8'	Door Header
15 pcs.	OSB Sheathing	4x8