



# ASSEMBLY INSTRUCTIONS

Pour le français, voir la page 3. Para el español, ver la página 2.

## OUTDOOR STORAGE SHED MODEL 60394



### BEFORE ASSEMBLY:

- Assemble on a level surface
- At least 3 people recommended for setup

## FOR OUTDOOR DOMESTIC USE ONLY! IMPORTANT, RETAIN FOR FUTURE REFERENCE: READ CAREFULLY

### TOOLS REQUIRED (NOT INCLUDED—UNLESS INDICATED OTHERWISE\*)



### TABLE OF CONTENTS

Icon Legend.....	4
Warnings & Notices.....	5
Platform Construction.....	6
Truss Assembly.....	11
Gable Assembly.....	16
Door Assembly.....	21
Floor Assembly.....	31
Wall Assembly.....	36
Parts Identifier.....	i-iv
Shelving Installation.....	42
Door Installation.....	47
Roof Assembly.....	51
Window Installation.....	61
Door Alignment.....	64
Shed Anchoring.....	67
Cleaning & Care.....	70
Registration.....	71
Warranty.....	73

### QUESTIONS?

Call: 1-800-225-3865  
(English, French, Spanish)

### CONTACT LIFETIME® CUSTOMER SERVICE:

Live Chat: [www.lifetime.com/customerservice](http://www.lifetime.com/customerservice)  
(Click on the "LIVE CHAT" tab)

For Customer Service in mainland Europe:  
E-mail: [csinternational@lifetime.com](mailto:csinternational@lifetime.com)

Model Number: 60394  
Product ID:



# INSTRUCTIONS D'ASSEMBLAGE

For English, see page 1. Para el español, ver la página 3.

## ABRI EXTÉRIEUR

MODÈLE n° 60394

### AVANT L'ASSEMBLAGE :

- Assembler sur une surface de niveau
- Nous recommandons, au moins, 3 adultes pour l'assemblage



**POUR L'USAGE DOMESTIQUE EN EXTÉRIEURS SEULEMENT !  
IMPORTANT, À CONSERVER POUR DE FUTURS BESOINS DE RÉFÉRENCE : À LIRE  
SOIGNEUSEMENT**

### OUTILS REQUIS (NON INCLUS — SAUF INDICATION CONTRAIRE\*)



### SOMMAIRE

Légende des icônes.....	4
Avertissements et avis.....	5
Assemblage de la plate-forme.....	6
Assemblage des fermes.....	11
Assemblage des pignons.....	16
Assemblage des portes.....	21
Assemblage du plancher.....	31
Assemblage des murs.....	36
Identificateur de pièces.....	i-iv
Installation du rayonnage.....	42
Installation des portes.....	47
Assemblage du toit.....	51
Installation des carreaux.....	61
Alignement des portes.....	64
L'ancrage de l'abri.....	67
Nettoyage et entretien.....	70
Enregistrement.....	71
Garantie.....	74

### QUESTIONS ?

Composer le 1-800-225-3865  
(anglais, français, espagnol)

### CONTACTER NOS SERVICES À LA CLIENTÈLE :

Chat en direct : [www.lifetime.com/customerservice](http://www.lifetime.com/customerservice)  
(Cliquer sur la languette « LIVE CHAT »)

Pour les services à la clientèle du continent européen :  
É-mail : [csinternational@lifetime.com](mailto:csinternational@lifetime.com)

N° de modèle : 60394  
Référence du produit :



# INSTRUCCIONES DE ENSAMBLAJE

For English, see page 1. Pour le français, voir la page 2.

## CASETA EXTERIOR

MODELO n° 60394

### ANTES DE ENSAMBLAR:

- Ensamblar sobre una superficie nivelada
- Recomendamos, al menos, 3 adultos para el ensamblaje



**¡SÓLO PARA USO DOMÉSTICO EN EXTERIORES!**  
**IMPORTANTE: CONSERVE PARA FUTURA REFERENCIA. LEA CUIDADOSAMENTE**

<b>INSTRUMENTAL REQUERIDO (NO INCLUIDO, SALVO INDICACIÓN CONTRARIA*)</b>		<b>ÍNDICE</b>
		<p>Leyenda de iconos.....4</p> <p>Advertencias y avisos.....5</p> <p>Ensamblaje de la plataforma.....6</p> <p>Ensamblaje de las cerchas.....11</p> <p>Ensamblaje de las fachadas.....16</p> <p>Ensamblaje de las puertas.....21</p> <p>Ensamblaje del piso.....31</p> <p>Ensamblaje de los muros.....36</p> <p>Identificador de piezas.....i-iv</p> <p>Instalación de la estantería.....42</p> <p>Instalación de las puertas.....47</p> <p>Ensamblaje del tejado.....51</p> <p>Instalación de las hojas de ventana.....61</p> <p>Alineación de la puertas.....64</p> <p>Anclaje de la caseta.....67</p> <p>Limpieza y cuidado.....70</p> <p>Registro.....71</p> <p>Garantía.....75</p>
<p>7/16 in (≈11 mm)</p> <p>3/8 in (≈10 mm)</p> <p>3/8 in (≈10 mm)</p> <p>5/16 in (≈8 mm) Broca para madera</p> <p>5/16 in (≈8 mm) Broca de albañilería</p> <p>ARA (x1) 1/8 po (≈3mm) incluido</p>		
<p><b>¿PREGUNTAS?</b></p> <p>Marcar al <b>1.800.225.3865</b> <i>Chat en vivo: <a href="http://www.lifetime.com/customerservice">www.lifetime.com/customerservice</a> (Clickear en la lengüeta "LIVE CHAT")</i></p> <p>Para el servicio a clientes en el continente europeo: Correo electrónico: <a href="mailto:csinternational@lifetime.com">csinternational@lifetime.com</a></p>		<p>Número de modelo: <b>60394</b> ID del producto:</p>



## ICON LEGEND / LÉGENDE DES ICÔNES / LEYENDA DE ÍCONOS



- Indicates special heed should be taken when reading.
- Indique qu'une attention spéciale doit être portée à la lecture.
- Indica que uno debe prestar atención al leer.

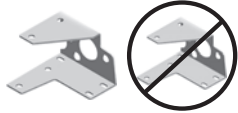

- Indicates the parts/no parts required for a section.
- Indique les pièces à utiliser/qu'aucune pièce n'est requise pour une section.
- Indica las piezas que se usarán/que no necesitan en una sección.



- Indicates the hardware to be used for a section.
- Indique la quincaillerie à utiliser pour une section.
- Indica el herraje que se usará para una sección.



- Indicates no hardware required for a specific page or section.
- Indique qu'aucune quincaillerie n'est requis pour une page précise.
- Indica que no se necesita herraje para una página específica.



- Indicates the tools to be used for a section.
- Indique les outils à utiliser pour une section.
- Indica las herramientas que se utilizarán para una sección.



- Indicates to use/not use an electric drill for a specific step.
- Indique quand utiliser une/que ne pas utiliser de perceuse électrique pour une étape précise.
- Indica la utilización de/que no utilizar un taladro eléctrico para un paso específico.



- These nuts are centerlock nuts. They are designed to be tight; therefore, they will be harder to tighten. Tighten until flush with the metal or plastic.
- Ces écrous sont des écrous de blocage central. Ils sont conçus pour être serrés; de ce fait, ils seront plus difficiles à resserrer. Serrer jusqu'à ce qu'ils soient au ras du métal ou du plastique.
- Estas tuercas son tuercas de bloqueo central. Están diseñadas para estar apretadas; por lo tanto, serán más difíciles de apretar. Apriételas hasta que estén al ras del metal o plástico.



- Indicates the number of adults required to perform a specific step, e.g., 2, 3, 4, etc.
- Indique le nombre d'adultes requis pour effectuer une étape spécifique, p. ex., 2, 3, 4, etc.
- Indica el número de adultos requeridos para realizar un paso específico, p.ej., 2, 3, 4, etc.





## WARNINGS & NOTICES / AVERTISSEMENTS ET AVIS / ADVERTENCIAS Y AVISOS



### English:

- **Failure to follow these warnings may result in serious injury or property damage and will void warranty.**
- To ensure safety, do not attempt to assemble this product without following the instructions carefully.
- Consult all local building codes to verify if the shed requires a building permit.
- Verify the foundation is completely level before assembling the shed.
- Be aware that plastic pieces can be damaged by overtightening the screws. To avoid damage, we strongly recommend the use of a drill with a low torque setting. A #2 Phillips screwdriver may also be used.
- Three capable adults are required for assembly.
- All who participate in the assembly process should wear safety glasses throughout the assembly.
- If using a ladder during assembly, use extreme caution.
-  In heavy snowfall areas, we recommend removing snow from the roof. Remove the snow from the roof when the depth of snow equals the length of your hand.
- Do not use or store hot objects near the product.
- Proper and complete assembly are essential to reduce the risk of accident or injury.
- When drilling through metal, beware of burrs, shavings and other sharp edges.
- During and after assembly, do not slide or lift the shed by pushing up on the roof. Move the shed by pushing on the corner panels only.
- Failure to anchor the shed may result in property damage and/or personal injury. The last section, *Shed Anchoring*, in this manual shows the hardware you will need to complete the anchoring. You can find the hardware at your local hardware store.
- **Most injuries are caused by misuse and/or not following instructions. Use caution when using this product.**

### Français :

- **Ne pas suivre ces avertissements peut entraîner des blessures graves ou des dommages à la propriété et annulera la garantie.**
- Afin d'assurer la sécurité, ne pas tenter d'assembler ce produit sans suivre attentivement les instructions.
- Consulter tous les codes du bâtiment afin de vérifier si l'abri nécessite un permis de construire.
- Vérifier que la fondation est complètement à niveau avant l'assemblage de l'abri.
- Ne pas oublier que les pièces de plastique peuvent être endommagées en serrant trop les vis. Afin d'éviter les dommages, nous recommandons fortement l'utilisation d'une perceuse à faible couple. Un tournevis cruciforme n° 2 peut aussi être utilisé.
- Trois adultes en bonne condition physique sont nécessaires pour l'assemblage.
- Tout ceux qui participent au processus de l'assemblage doivent porter des lunettes de sécurité tout au long de l'assemblage.
- Si une échelle est utilisée pour l'assemblage, il faut être extrêmement prudent.
- Dans les zones de fortes tombées de neige, il est recommandé de dégager le toit. Enlever la neige du toit quand la profondeur est égale à la longueur de la main.
- Ne pas utiliser ou entreposer des objets très chauds près de ce produit.
-  Un bon assemblage complet est nécessaire pour réduire le risque d'accident ou de blessure.
-  En perçant le métal, faire attention aux bavures, copeaux et autre bords aiguisés.
- Pendant et après l'assemblage, ne pas faire glisser ou soulever l'abri en poussant le toit vers le haut. Déplacer l'abri en poussant les panneaux muraux angulaires seulement.
- Si vous n'ancrez pas votre abri, des dommages à la propriété et/ou des blessures peuvent en résulter. La dernière section, *Ancrage de l'abri*, de ce manuel indique les matériaux nécessaires pour l'ancrage. Les matériaux se trouvent dans la quincaillerie locale.
- **La majorité des blessures sont causées par une mauvaise utilisation et/ou le non suivi des instructions. Être prudent en utilisant ce produit.**

### Español:

- **No seguir estas advertencias puede resultar en lesiones graves o daños a la propiedad y anulará la garantía.**
- A fin de garantizar la seguridad, no intentar ensamblar este producto sin seguir cuidadosamente las instrucciones.
- Consultar todos los códigos de construcción locales para verificar si la caseta requiere un permiso de construcción.
- Verificar que el concreto esté nivelado completamente antes de ensamblar la caseta.
- Tener en cuenta que las piezas de plástico pueden dañarse si los tornillos se aprietan de más. A fin de evitar daños, lo exhortamos a que use un taladro con función de torque bajo. También puede usarse un desatornillador Phillips no. 2.
- Se necesitan tres adultos para el ensamble.
- Todos los que participen en el proceso de ensamble debe usar anteojos de seguridad durante todo el ensamble.
- Si se usa una escalera durante el ensamblado, es preciso tener cuidado.
- En áreas de nevadas fuertes, recomendamos retirar la nieve del techo. Quitar la nieve del tejado cuando la profundidad de ella es igual a la longitud de la mano.
- No usar ni guardar objetos calientes cerca del producto.
-  El ensamblaje correcto y completo son esenciales para reducir el riesgo de accidente o lesión.
-  Al perforar metal, tenga cuidado las rebabas, virutas y otros bordes afilados.
- Durante y después del ensamblaje, no deslizar ni levantar la caseta para empujar en el tejado. Mover la caseta para empujar los paneles murales angulares solamente.
- No anclar la caseta puede resultar en daños a la propiedad y/o en lesiones personales. La última sección, *Anclaje de la caseta*, en este manual muestra el herraje necesaria para terminar el anclaje. Se encuentra el herraje en la ferretería local.
- **La mayoría de las lesiones suceden a causa del mal uso y/o por no seguir las instrucciones. Tener precaución al usar este producto.**



• You must provide a platform on which to assemble your shed. Proper building permit documentation may be required in your neighborhood. Consult all local building codes prior to assembling the shed. Before beginning assembly, you must pour or construct a platform. There are two types:

- Concrete
- Wood Frame

Select the type, but know the surface must be leveled and flat before installation. If the surface is not properly leveled and flat, the shed will not assemble correctly. Proper surface leveling will save you time in the long run, so please do not ignore this step.

**We recommend a Concrete platform. It will be the most durable and long-lasting choice. The platform you choose must be built above ground in order to avoid water pooling inside the shed. All lumber must be rated for outdoor use!**



• Il faut construire une plate-forme pour l'abri. Il est possible que le quartier exige une documentation visant les permis de construire. Consulter tous les codes du bâtiment locaux, ainsi que les décrets des villes et comtés, pour vérifier que la construction de l'abri extérieur n'exige pas un permis de construire. Avant de commencer l'assemblage, il faut couler ou construire une plate-forme. Il y a deux styles :

- Béton
- Cadre à bois

Sélectionner le style, mais savoir que la surface d'installation doit être de niveau et plate. Si la surface n'est pas correctement de niveau et plate, l'assemblage de l'abri ne se fera pas correctement. Un gain de temps sur le long terme sera évident grâce à une surface bien de niveau, ne pas négliger cette étape. **Nous recommandons une plate-forme en béton. Ce choix sera le plus durable. La plate-forme choisie doit être construite au-dessus du sol afin d'éviter l'accumulation d'eau à l'intérieur de l'abri. Tous le bois d'oeuvre doit être approuvé pour l'usage à l'extérieur !**



• Es preciso construir una plataforma sobre la cual usted debe ensamblar su caseta. Se puede suceder que en el vecindario se requiera la documentación apropiada de un permiso de construcción. Consultar todos los códigos locales de construcción y los reglamentos de la ciudad y el municipio para asegurarse de que la construcción de la caseta no requiere un permiso de construcción. Antes de comenzar el ensamble, es necesario verter o construir una plataforma. Hay dos clases:

- Concreto
- Armazón de madera

Seleccionar la clase, mas saber que la superficie debe estar nivelada y plana antes de comenzar el ensamble. Si la superficie no está nivelada y plana de manera adecuada, la caseta no podrá armarse correctamente. La nivelación de la superficie le ahorrará tiempo de trabajo, por lo tanto, no ignorar este paso. **Recomendamos una plataforma hecho de concreto. Será la elección más perdurable. La plataforma debe ser construida arriba del suelo para evitar el flujo de agua dentro de la caseta. ¡Toda la madera debe estar clasificada para el uso externo!**

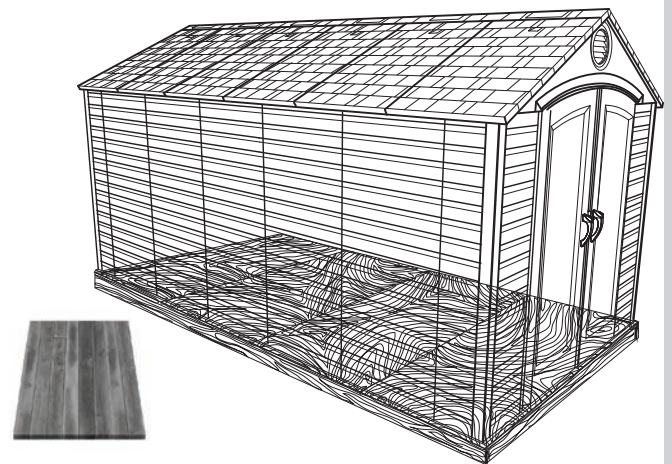
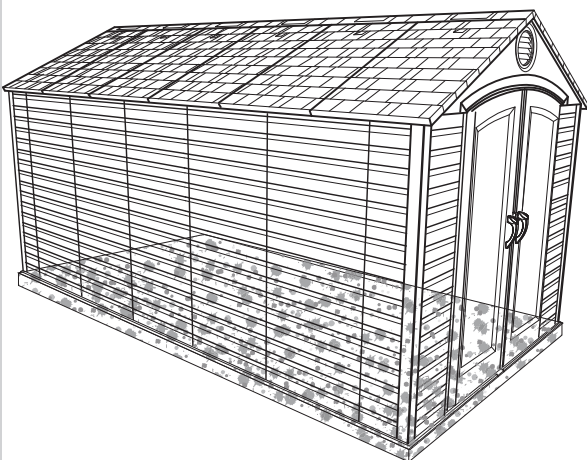

## ► SECTION 1 (CONTINUED) / SECTION 1 (SUITE) / SECCIÓN 1 (CONTINUACIÓN)

CONCRETE REQUIRED / BÉTON REQUIS / CONCRETO REQUERIDO



2 yd<sup>3</sup> (≈1,53 m<sup>3</sup>)

### 1.1

#### CONCRETE PLATFORM / PLATAFORMA DE CONCRETO / PLATE-FORME EN BÉTON

- The concrete should be approximately 4" (≈10,2 cm) thick. The actual dimensions of the shed, at its widest and longest points, are 96" x 180" (≈2,44 m x ≈4,57 m). Ensure you select a site that will accommodate these measurements. **The floor dimensions are a bit smaller than those of the roof; therefore, you will need to build a level surface of 93 1/2" x 178" (≈2,38 m x ≈4,52 m).**
- Le béton doit être un épaisseur de 4 po (≈10,2 cm). Les dimensions réelles de votre abri, aux points les plus large et long, sont 96 po x 180 po (≈2,44 m x ≈4,57 m). Veiller à sélectionner un site qui accommodera ces dimensions. **Les dimensions du plancher de votre abri sont plus petites que le toit; ensuite, il faut créer une surface horizontale de 93 1/2 po x 178 po (≈2,38 m x ≈4,52 m).**
- El concreto debe tener, por lo menos, 4 in (≈10,2 cm) de espesor. Las dimensiones reales de la caseta, a sus puntos más ancho y largo, son 96 in x 180 in (≈2,44 m x ≈4,57 m). Asegurarse de seleccionar un sitio que acomodará estas medidas. **Las dimensiones del piso de la caseta son más pequeñas que el tejado; entonces, se necesita crear una superficie nivel de 93 1/2 in x 178 in (≈2,38 m x ≈4,52 m).**

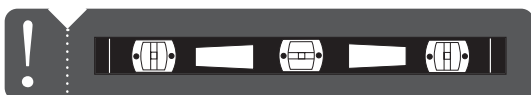
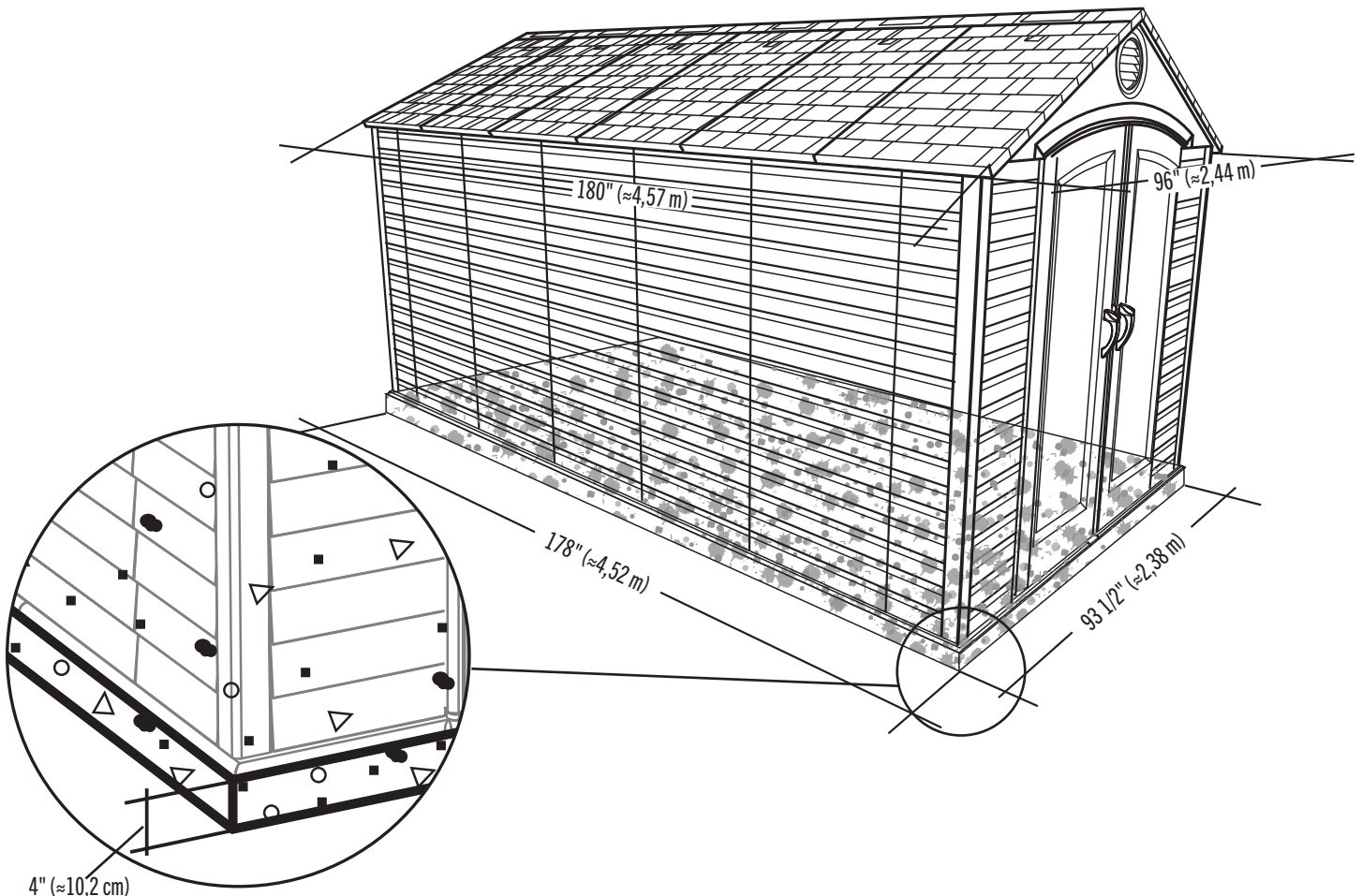

## ► SECTION 1 (CONTINUED) / SECTION 1 (SUITE) / SECCIÓN 1 (CONTINUACIÓN)

WOOD REQUIRED / BOIS REQUIS / MADERA REQUERIDA



### 1.2

#### WOOD PLATFORM / PLATE-FORME EN BOIS / PLATAFORMA DE MADERA

- The actual dimensions of the shed, at its widest and longest points, are 96" x 180" ( $\approx 2,44$  m x  $\approx 4,57$  m). Ensure you select a site that will accommodate these measurements. **The floor dimensions are a bit smaller than those of the roof; therefore, you will need to build a level surface of 93 1/2" x 178" (2,38 m x 4,52 m).**
- Les dimensions réelles de votre abri, aux points les plus large et long, sont 96 po x 180 po ( $\approx 2,44$  m x  $\approx 4,57$  m). Veiller à sélectionner un site qui accommodera ces dimensions. **Les dimensions du plancher de votre abri sont plus petites que le toit; ensuite, il faut créer une surface horizontale de 93 1/2 po x 178 po ( $\approx 2,38$  m x  $\approx 4,52$  m).**
- Las dimensiones reales de la caseta, a sus puntos más ancho y largo, son 96 in x 180 in ( $\approx 2,44$  m x  $\approx 4,57$  m). Asegurarse de seleccionar un sitio que acomodará estas medidas. **Las dimensiones del piso de la caseta son más pequeñas que el tejado; entonces, se necesita crear una superficie nivel de 93 1/2 in x 178 in ( $\approx 2,38$  m x  $\approx 4,52$  m).**

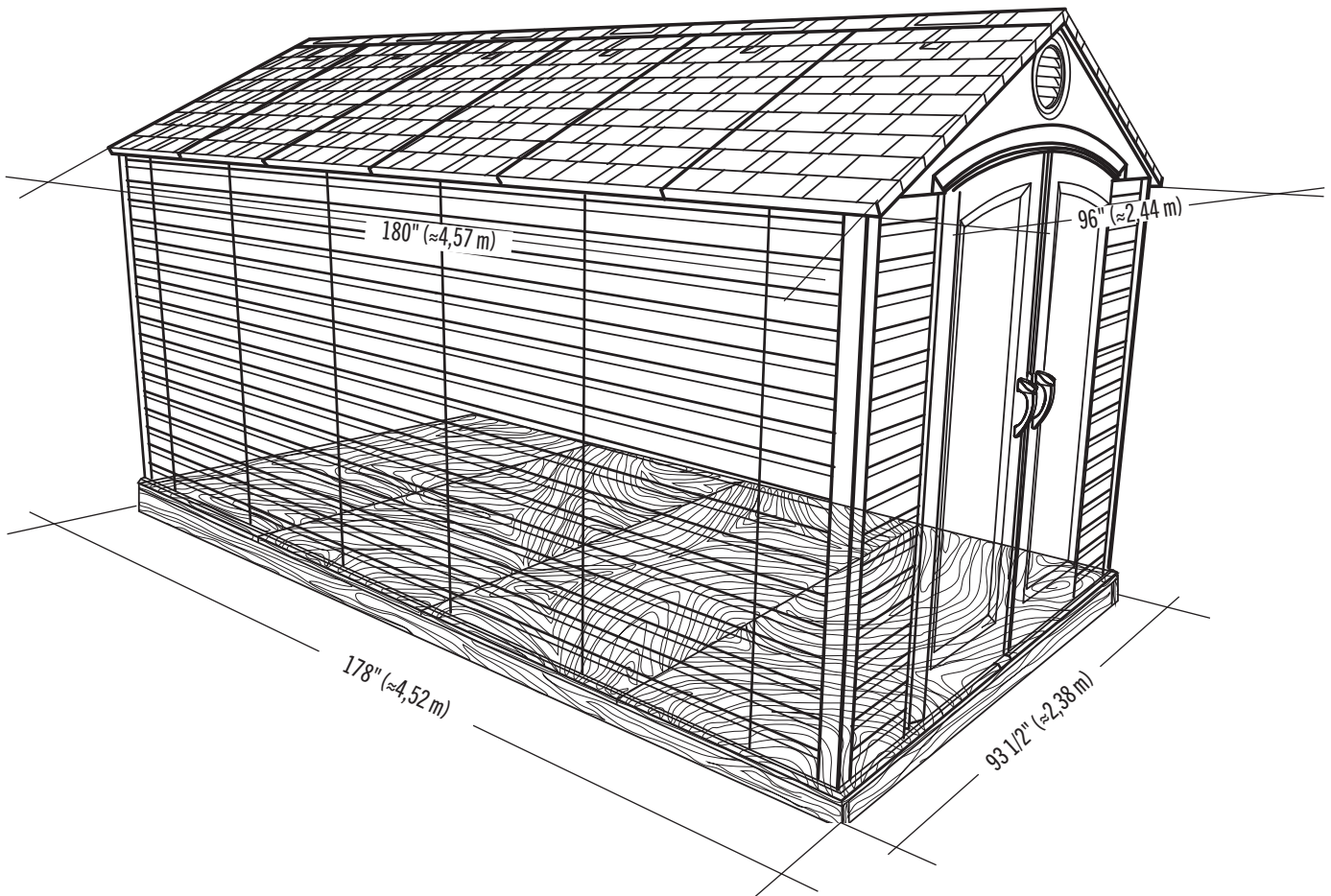



## SECTION 1 (CONTINUED) / SECTION 1 (SUITE) / SECCIÓN 1 (CONTINUACIÓN)

TOOLS, PARTS, AND HARDWARE REQUIRED / OUTILS, PIÈCES, ET QUINCAILLERIE REQUIS / INSTRUMENTAL, PIEZAS, Y HERRAJE REQUERIDOS

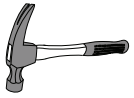

2" x 4" x 178" (≈5,1 cm x ≈10,2 cm x ≈4,52 m) (x2)



2" x 4" x 90 1/2" (≈5,1 cm x ≈10,2 cm x ≈2,30 m) (x13)

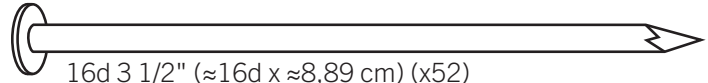

16d 3 1/2" (≈16d x ≈8,89 cm) (x52)

### 1.2.1

#### WOOD PLATFORM / PLATE-FORME EN BOIS / PLATAFORMA DE MADERA

- Ensure all lumber is treated and approved for outdoor use. Build frame to 93 1/2" x 178" (≈2,38 m x ≈4,52 m) (outside dimensions). You can also use a sheet of plywood as a flat surface when building this frame.
- Vérifier que votre bois d'œuvre à été traité et approuvé pour l'utilisation à l'extérieur. Construire un cadre de 93 1/2 po x 178 po (≈2,38 m x ≈4,52 m) (dimensions extérieures). Une feuille de contreplaqué peut être utilisée comme une surface plate pendant l'assemblage de ce cadre.
- Asegurarse de usar madera tratada y aprobada para el uso externo. Construir el armazón a 93 1/2 in x 178 in (≈2,38 m x ≈4,52 m) (dimensiones exteriores). Se puede también usar el contrachapado como una superficie plana al ensamblar este armazón.

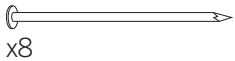

x8

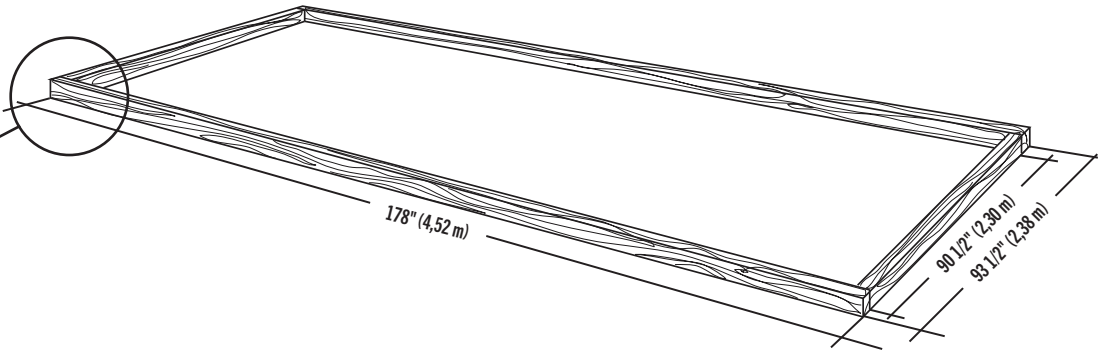
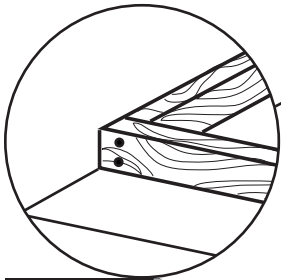

### 1.2.2

- To ensure studs are in the correct location for nailing plywood in the next step, start measuring from the corner 16" (≈40,6 cm), and then measure from center to center.
- Pour être sûr d'avoir assez de montant pour clouer le contreplaqué dans le prochaine étape, commencer à mesurer à partir de cette montant 16 po (≈40,6 cm) vers le centre du deuxième montant. Ensuite, mesurer de centre à centre pour les montants restants.
- Para asegurarse que los montantes están en las ubicaciones correctas para el contrachapado en el paso siguiente, comenzar a medir desde el borde del montante hasta el centro del próximo montante 16 in (≈40,6 cm). Luego, tomar la medida de centro a centro en los montantes restantes.

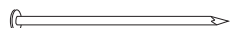

x44

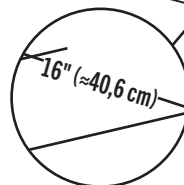
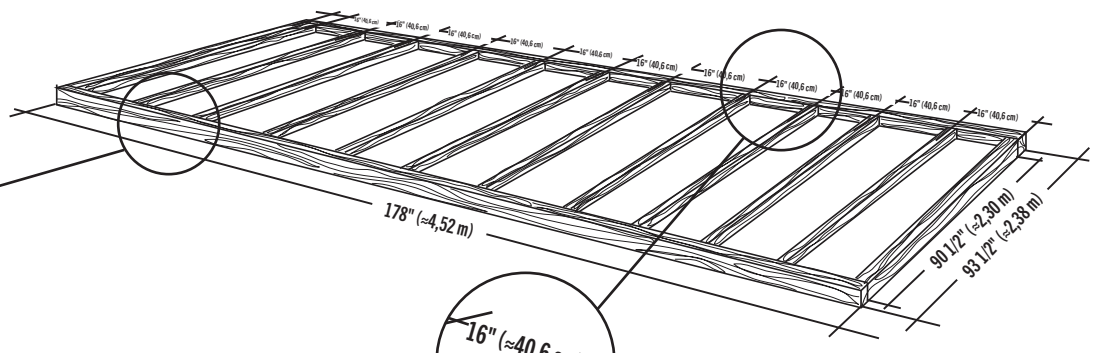
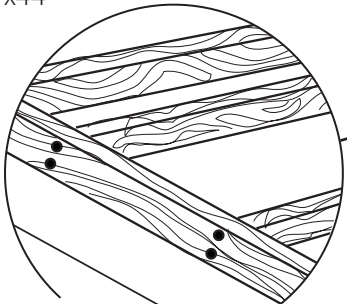

## SECTION 1 (CONTINUED) / SECTION 1 (SUITE) / SECCIÓN 1 (CONTINUACIÓN)

TOOLS, PARTS, AND HARDWARE REQUIRED / OUTILS, PIÈCES, ET QUINCAILLERIE REQUIS / INSTRUMENTAL, PIEZAS, Y HERRAJE REQUERIDOS

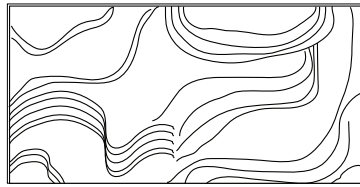
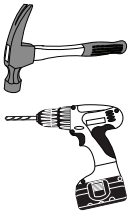

48" x 93 1/2" x 3/4"  
(≈1,22 m x ≈2,38 m x ≈19,1 mm) (x3)



34" x 93 1/2" x 3/4"  
(≈86,4 cm x ≈2,38 m x ≈19,1 mm) (x1)

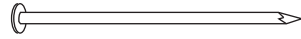

4d 1 1/2" (4d ≈3,81 cm) (x84)

### 1.23

- Square the frame, measuring from corner to corner. **Measurement A & B should be about the same length.**
- Carrer le cadre en mesurant d'angle à angle. **La mesure "A" et "B" doivent être à peu près la même longueur.**
- Cuadrar el armazón mediendo de esquina a esquina. **La medida "A" y "B" deben ser aproximadamente el mismo largo.**

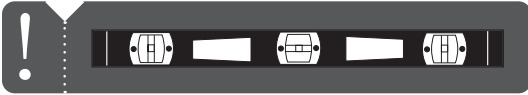
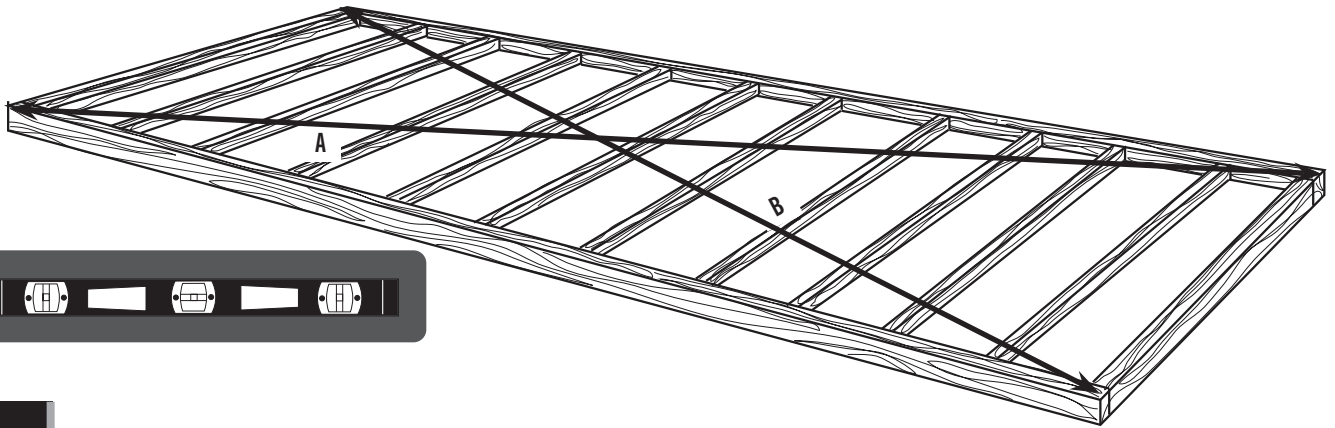

### 1.24

- Using nails, fasten the plywood to the frame. Then, drill 5/16" holes for drainage.
- En utilisant des clous, attacher bien le contreplaqué au cadre. Ensuite, percer des trous de 8 mm pour le drainage.
- Usando unos clavos, sujetar el contrachapado al armazón. Entonces, taladrar agujeros de 8 mm para el drenaje.

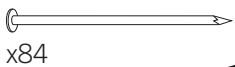

x84

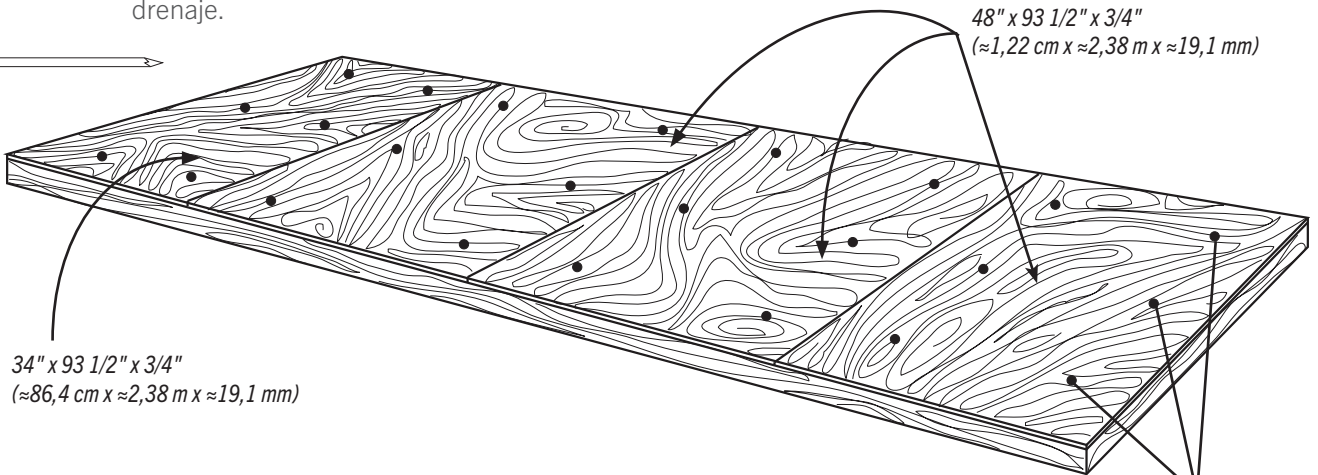

48" x 93 1/2" x 3/4"  
(≈1,22 cm x ≈2,38 m x ≈19,1 mm)

34" x 93 1/2" x 3/4"  
(≈86,4 cm x ≈2,38 m x ≈19,1 mm)

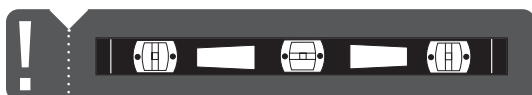

Drainage Holes  
Trous de drainage  
Agujeros para desagüe

## x24!

# 2

## TRUSS ASSEMBLY / ASSEMBLAGE DES FERMES / ENSAMBLAJE DE LAS CERCHAS



### HARDWARE REQUIRED / QUINCAILLERIE REQUISE / HERRAJE REQUERIDO

Hardware Bag / Sac de quincaillerie / Bolsa de herraje

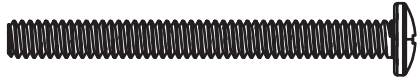

DTK (x20)



ADJ (x10)

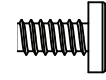

ADY (x20)



ADK (x40)

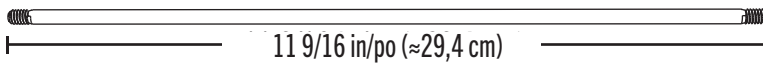

11 9/16 in/po (≈29,4 cm)

ADH (x5)

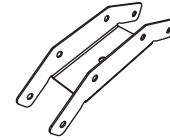

AIP (x5)



### PARTS REQUIRED / PIÈCES REQUISES / PIEZAS REQUERIDAS

Metal Parts / Pièces en métal / Piezas de metal



50 9/16 in/po (≈1,28 m)

DSR (x10)

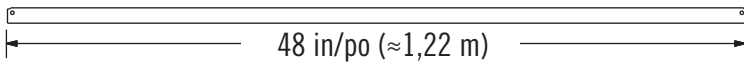

48 in/po (≈1,22 m)

AFG (x5)

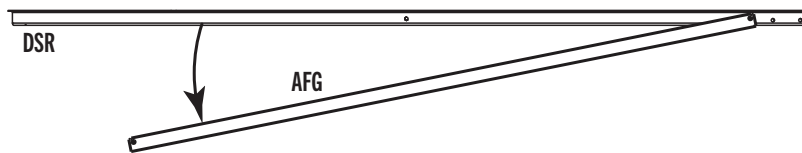
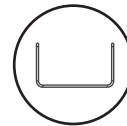

**!** • Sometimes during shipping, the truss brace (AFG) slides over the back of the truss gutter channel (DSR). The two pieces are the same color. If you think you're missing a truss brace, check to see if it is stuck to the back of the truss gutter channel, and separate the two.

• Durant le transport, parfois le support de ferme (AFG) glisse par-dessus l'arrière du canal de ferme (DSR). Les deux pièces sont du même colour. Si vous pensez que vous n'avez pas de support de ferme, vérifiez s'il y a un support de ferme adhérent à l'arrière du canal de ferme, et séparez les deux.

• Durante el transporte, a veces el soporte de cercha (AFG) deslice sobre el dorso del canalón de cercha (DSR). Las dos piezas son de la misma color. Si piensa que le falta un soporte de cercha, verifique si haya un soporte pegado al dorso del canalón de cercha, y separe las dos.



### TOOLS REQUIRED (NOT INCLUDED—UNLESS INDICATED OTHERWISE\*) / OUTILS REQUIS (NON INCLUS—SAUF INDICATION CONTRAIRE\*) / INSTRUMENTAL REQUERIDO (NO INCLUIDO, SALVO INDICACIÓN CONTRARIA\*)



7/16 in/po (≈11 mm) (x2)



3/8 in/po (≈10 mm)

## ► SECTION 2 (CONTINUED) / SECTION 2 (SUITE) / SECCIÓN 2 (CONTINUACIÓN)

TOOLS AND HARDWARE REQUIRED / OUTILS ET QUINCAILLERIE REQUIS / INSTRUMENTAL Y HERRAJE REQUERIDOS



3/8 in/po  
(≈10 mm)



DTK (x4)



ADK (x4)

### 2.1

- Slide a **connector (AIP)** onto the ends of two **truss gutter channels (DSR)** as shown.
- Faire glisser un **raccord (AIP)** sur les extrémités des **canaux de gouttière (DSR)** comme illustré.
- Deslizar un **connector (AIP)** en los extremos de los **canalones de la cercha (DSR)** como se muestra.

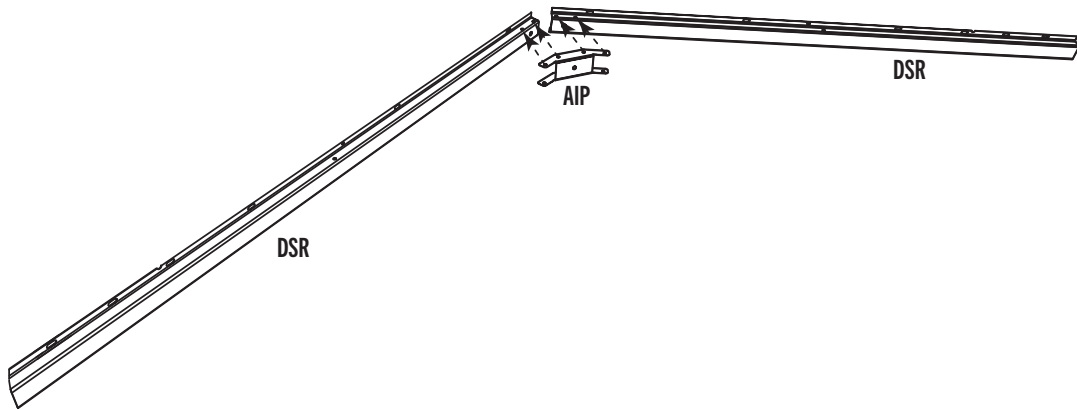

### 2.2

- Attach the **connector** using the hardware indicated. **Do not overtighten the cap nuts.**
- Attacher le **raccord (AIP)** à l'aide des accessoires indiqués. **Ne pas serrer excessivement les écrous à chape.**
- Sujetar el **connector (AIP)** usando el herraje indicado. **No apriete demasiado las tuercas ciegas.**

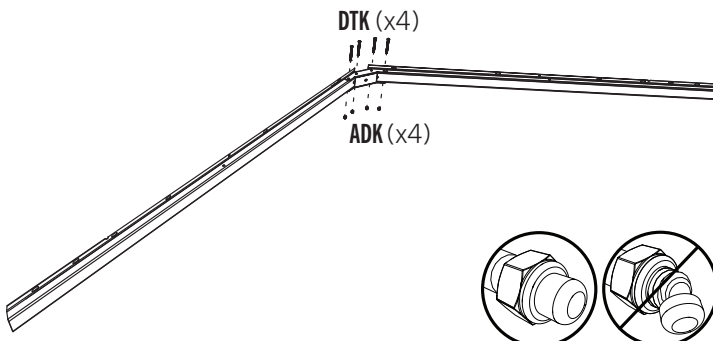

### 2.3

- Slide a **large truss brace (AFG)** onto the truss gutter channels as shown, and align the holes.
- Faire glisser un **support grand de la ferme (AFG)** sur les canaux de gouttière comme indiqué, et aligner les trous.
- Deslizar un **soporte grande de la cercha (AFG)** sobre los canalones de la cercha como se muestra, y alinear los agujeros.

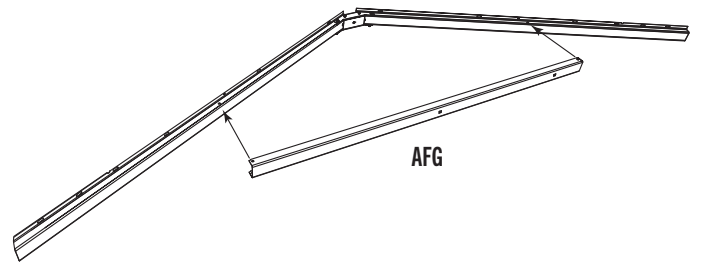

## ► SECTION 2 (CONTINUED) / SECTION 2 (SUITE) / SECCIÓN 2 (CONTINUACIÓN)

TOOLS AND HARDWARE REQUIRED / OUTILS ET QUINCAILLERIE REQUIS / INSTRUMENTAL Y HERRAJE REQUERIDOS



3/8 in/po  
(≈10 mm)

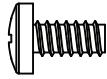

ADY (x4)



ADK (x4)

### 2.4

- Attach the large truss brace using the hardware included. **Do not overtighten the cap nuts.**
- Attacher le support grand de la ferme à l'aide de la quincaillerie incluse. **Ne pas serrer excessivement les écrous à chape.**
- Sujetar el soporte grande de la cercha usando el herraje incluido. **No apretar demasiado las tuercas ciegas.**

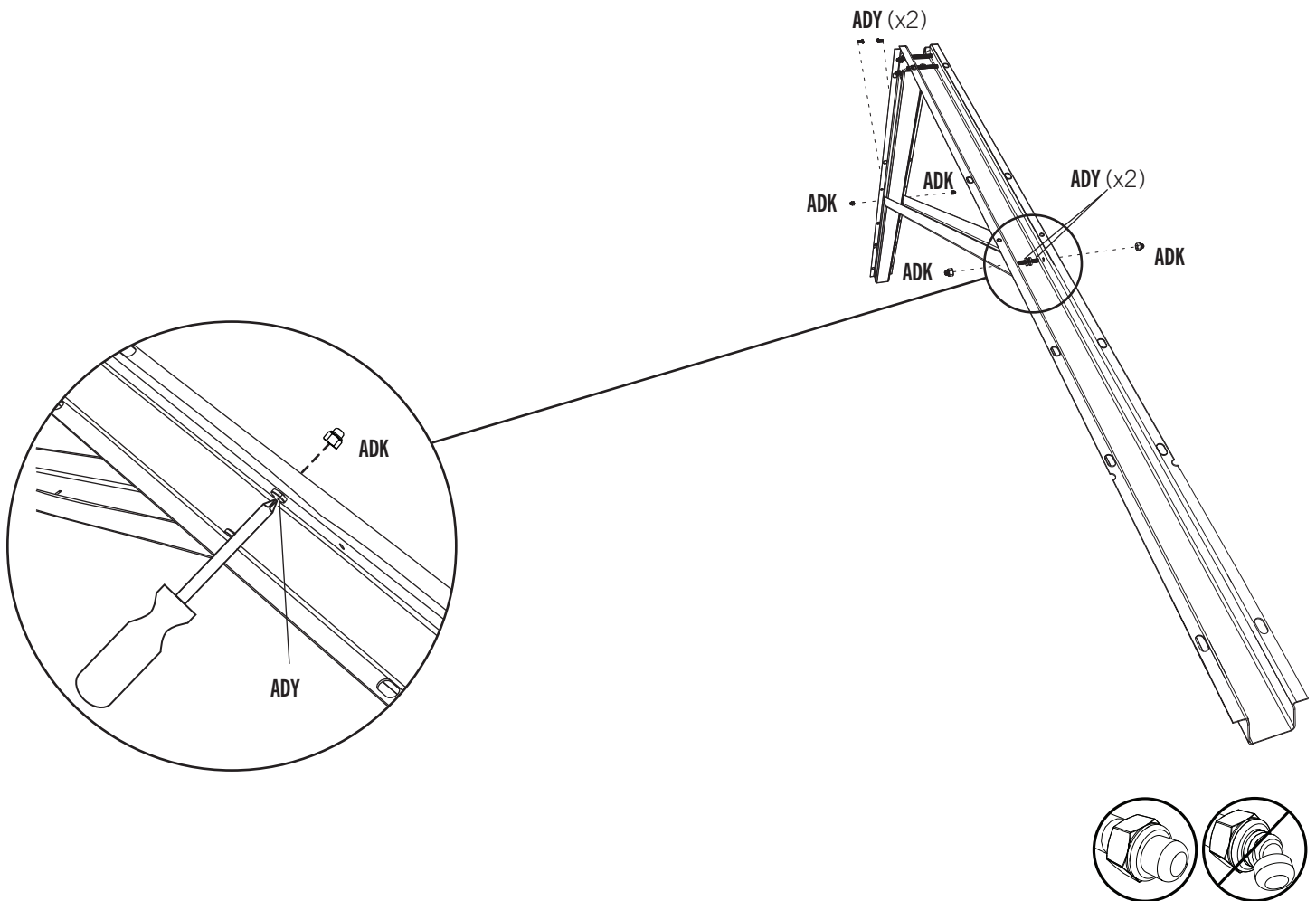

## ► SECTION 2 (CONTINUED) / SECTION 2 (SUITE) / SECCIÓN 2 (CONTINUACIÓN)

TOOLS AND HARDWARE REQUIRED / OUTILS ET QUINCAILLERIE REQUIS / INSTRUMENTAL Y HERRAJE REQUERIDOS



7/16 in/po  
(≈11 mm) (x2)



ADJ (x2)

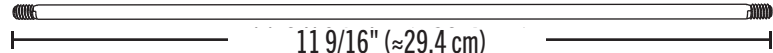

ADH (x1)

# 2.5

- Slide a **truss rod (ADH)** through the holes in the large truss brace and connector. Secure with two **cap nuts (ADJ)**. **Do not overtighten the nuts.**
- Faire glisser une **tige (ADH)** à travers les trous dans le grand support et le raccord. L'attacher bien à l'aide de deux **écrous à chape (ADJ)**. **Ne pas serrer excessivement les écrous.**
- Deslizar una **varilla (ADH)** a través de los agujeros en el soporte grande y el conector. Sujetarla con dos **tuercas ciegas (ADJ)**. **No apretar demasiado las tuercas.**

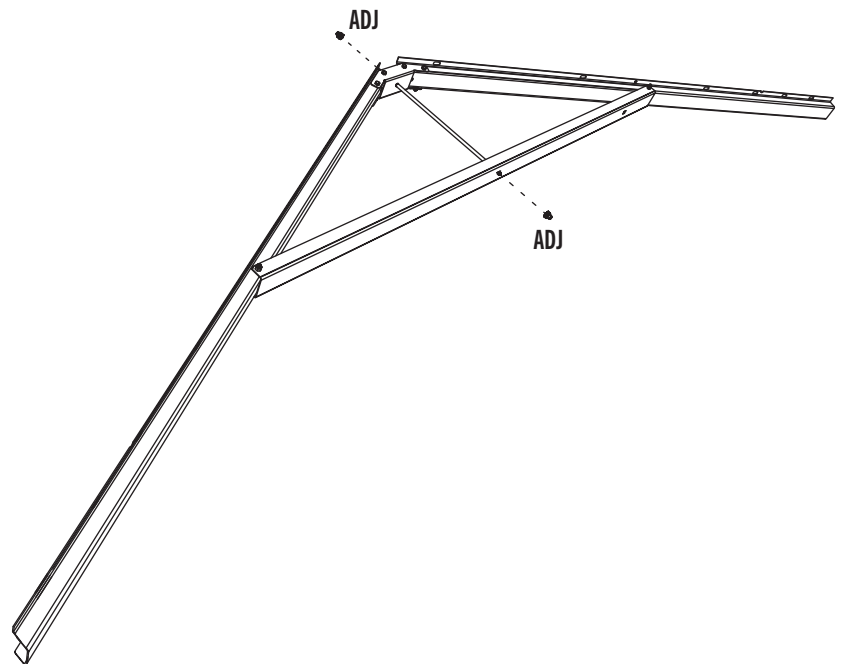
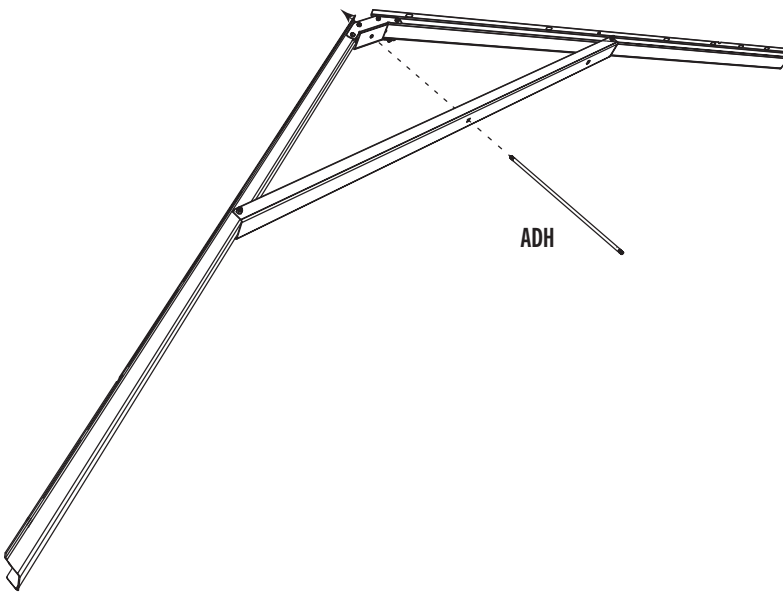

## SECTION 2 (CONTINUED) / SECTION 2 (SUITE) / SECCIÓN 2 (CONTINUACIÓN)

TOOLS AND HARDWARE REQUIRED / OUTILS ET QUINCAILLERIE REQUIS / INSTRUMENTAL Y HERRAJE REQUERIDOS



3/8 in/po  
(≈10 mm)



7/16 in/po  
(≈11 mm) (x2)

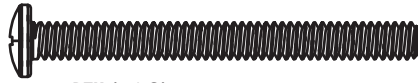

DTK (x16)



ADK (x32)

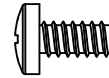

ADY (x16)



ADJ (x8)

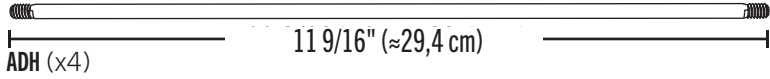

ADH (x4)

11 9/16" (≈29,4 cm)

# 2.6

- Repeat steps 2.1–2.5 four times.
- Répéter les étapes 2.1 – 2.5 quatre fois.
- Repetir los pasos 2.1–2.5 cuatro veces.

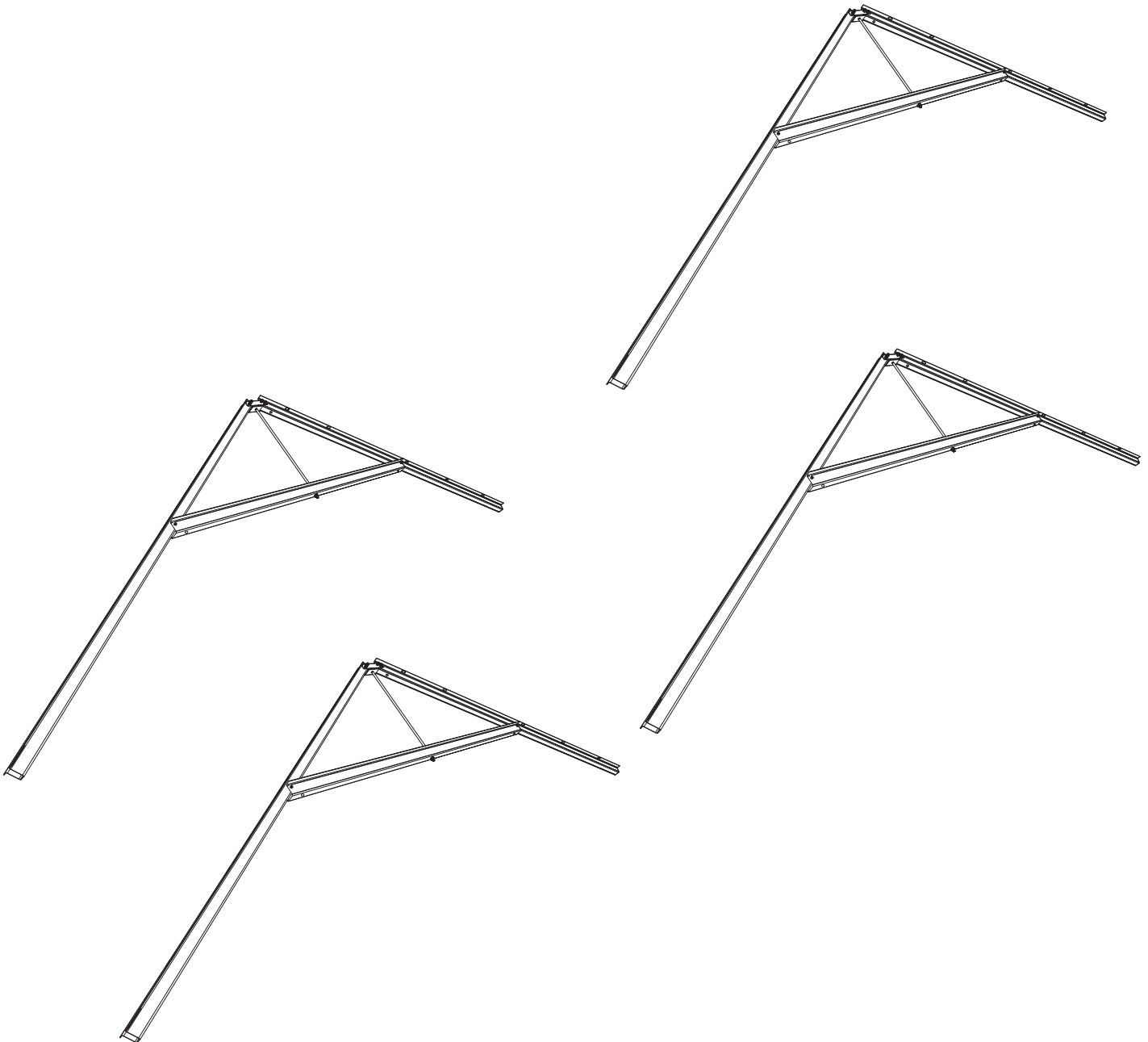

# 3

## GABLE ASSEMBLY / ASSEMBLAGE DES PIGNONS / ENSAMBLAJE DE LAS FACHADAS



### HARDWARE REQUIRED / QUINCAILLERIE REQUISE / HERRAJE REQUERIDO

Hardware Bag / Sac de quincaillerie / Bolsa de herraje



ADW (x10)

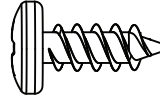

ADZ (x6)



ADK (x2)

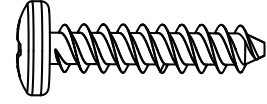

ADV (x6)

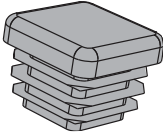

AHS (x2)



EYR (x2)



CXK (x2)

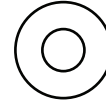

AEE (x14)



EYQ (x2)

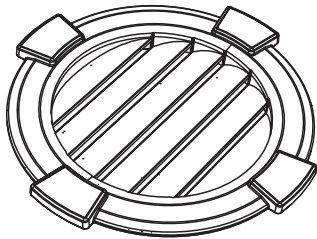

ENH (x2)

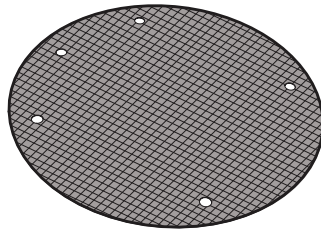

AIQ (x2)



### PARTS REQUIRED / PIÈCES REQUISES / PIEZAS REQUERIDAS

Metal Part / Pièce en métal / Pieza de metal



EYS (x1)

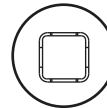

Plastic Parts / Pièces en plastique / Piezas de plástico

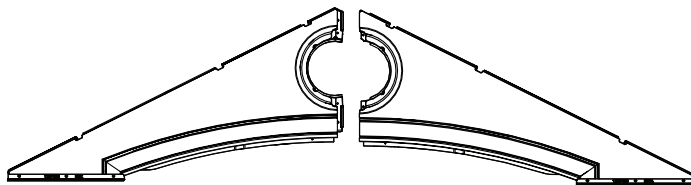

EVZ (x1)

EWA (x1)

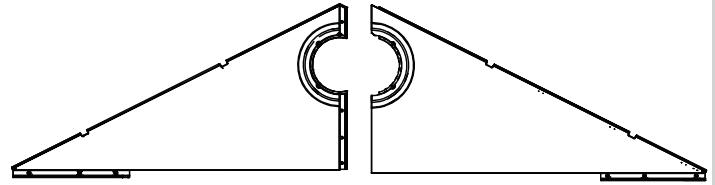

AGI (x1)

AGH (x1)



### TOOLS REQUIRED (NOT INCLUDED—UNLESS INDICATED OTHERWISE\*) / OUTILS REQUIS (NON INCLUS—SAUF INDICATION CONTRAIRE\*) / INSTRUMENTAL REQUERIDO (NO INCLUIDO, SALVO INDICACIÓN CONTRARIA\*)



3/8 in/po (≈10 mm)



## ► SECTION 3 (CONTINUED) / SECTION 3 (SUITE) / SECCIÓN 3 (CONTINUACIÓN)

TOOLS AND HARDWARE REQUIRED / OUTILS ET QUINCAILLERIE REQUIS / INSTRUMENTAL Y HERRAJE REQUERIDOS

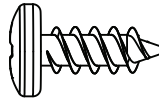

ADZ (x4)

### 3.1

- Align the holes in the **left (AGH)** and **right (AGI)** rear gable halves.
- Aligner les trous dans les **pignons gauche (AGH)** et **droite (AGI)**.
- Alinear los agujeros en las **fachadas traseras izquierda (AGH)** y **derecha (AGI)**.

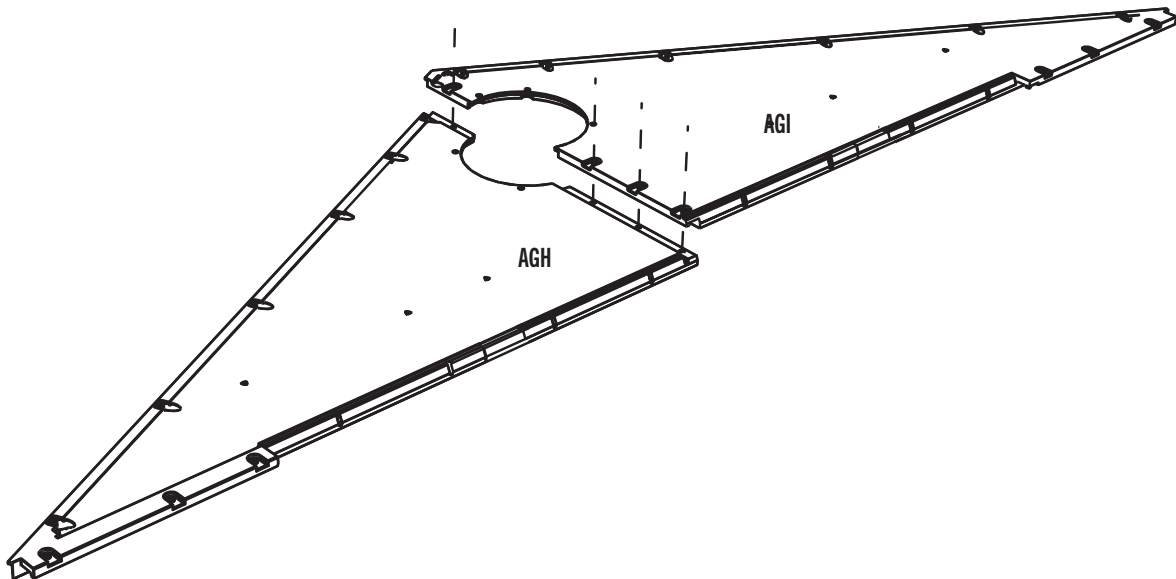

### 3.2

- Secure the two gable halves with four (4) **screws (ADZ)**.
- Attacher l'un à l'autre à l'aide de quatre (4) **vis (ADZ)**.
- Sujetar el uno al otro usando cuatro (4) **tornillos (ADZ)**.

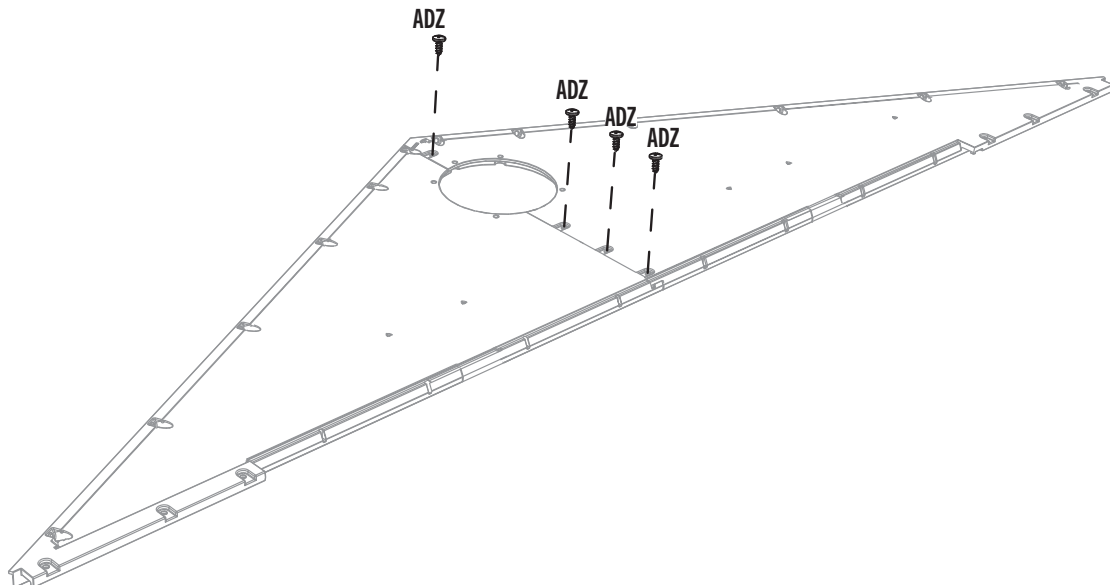

### SECTION 3 (CONTINUED) / SECTION 3 (SUITE) / SECCIÓN 3 (CONTINUACIÓN)

TOOLS AND HARDWARE REQUIRED / OUTILS ET QUINCAILLERIE REQUIS / INSTRUMENTAL Y HERRAJE REQUERIDOS



3/8 in/po  
(≈10 mm)

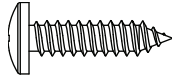

ADW (x5)

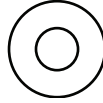

AEE (x5)

## 3.3

- Place the **screen (AIQ)** over the **vent (ENH)**, and align the five holes in the vent with those in the gable.
- Mettre la **moustiquaire (AIQ)** sur l'**évent (ENH)**, et aligner les cinq trous dans l'évent avec ceux du pignon.
- Colocar el **mosquitero (AIQ)** sobre la **rejilla de ventilación (ENH)**, y alinear los agujeros en la rejilla con los de la fachada.

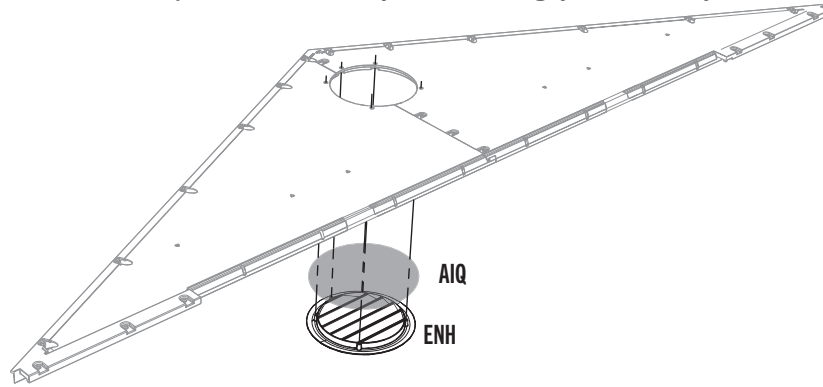

## 3.4

- Secure with the hardware included.
- Attacher-les en utilisant la quincaillerie incluse.
- Sujetar los unos a los otros usando el herraje incluido.

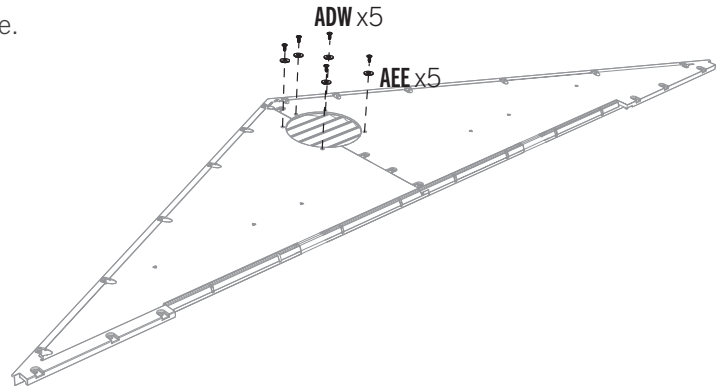

## 3.5

- Align the holes in the **left (EVZ)** and **right (EWA)** entry gable halves.
- Aligner les trous dans les **demis pignons d'entrée gauche (EVZ)** et **droit (EWA)**.
- Alinear los agujeros en las **mitades de la fachada trasera izquierda (EVZ)** y **derecha (EWA)**.

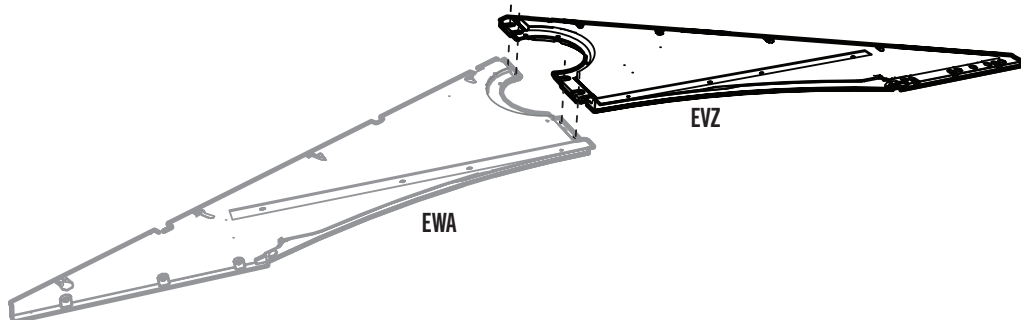

### SECTION 3 (CONTINUED) / SECTION 3 (SUITE) / SECCIÓN 3 (CONTINUACIÓN)

TOOLS AND HARDWARE REQUIRED / OUTILS ET QUINCAILLERIE REQUIS / INSTRUMENTAL Y HERRAJE REQUERIDOS

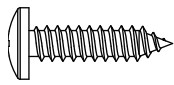

ADW (x5)

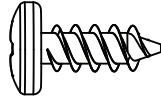

ADZ (x2)

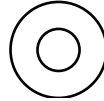

AEE (x7)

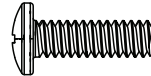

EYQ (x2)



CXK (x2)

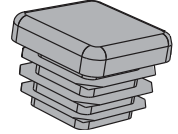

AHS (x2)

## 3.6

- Secure with the hardware included. **Do not overtighten.**
- Fixer à l'aide de la quincaillerie incluse. **Ne pas trop serrer.**
- Sujetar con el herraje incluido. **No apretar demasiado.**

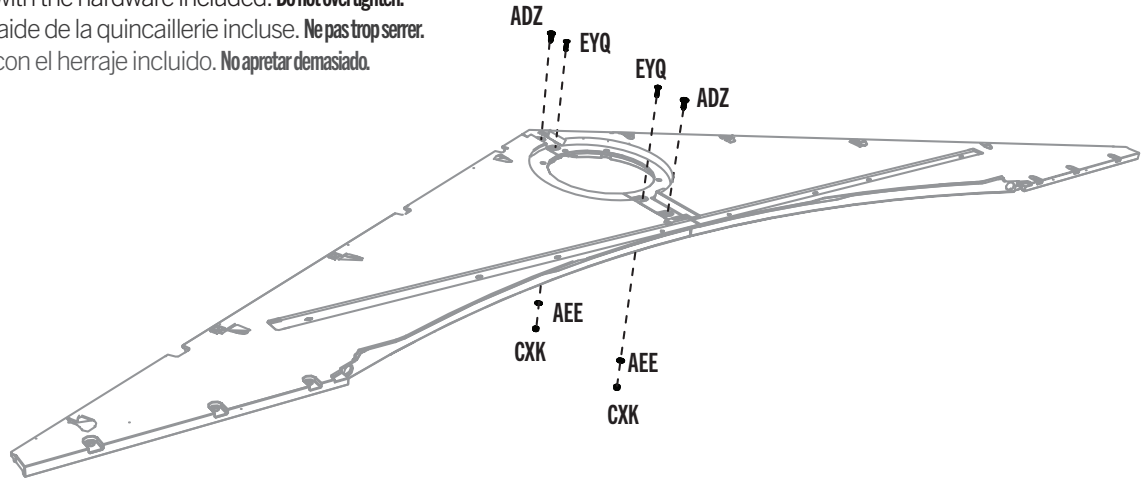

## 3.7

- Repeat steps 3.3–3.4 for the entry gable.
- Répéter les étapes 3.3 – 3.4 pour le pignon d'entrée.
- Repetir los pasos 3.3–3.4 para la fachada de entrada.

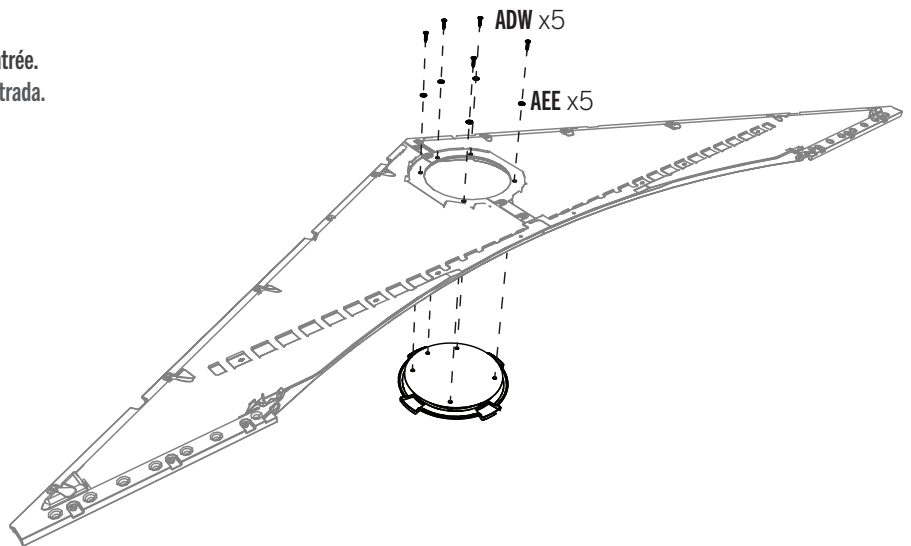
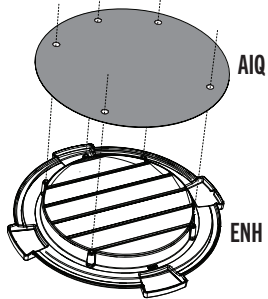

## 3.8

- Insert an **end cap (AHS)** into each end of the **header (EYS)**.
- Insérer un **capuchon (AHS)** dans chaque extrémité du **linteau (EYS)**.
- Insertar un **tapón (AHS)** en cada extremo del **dintel (EYS)**.

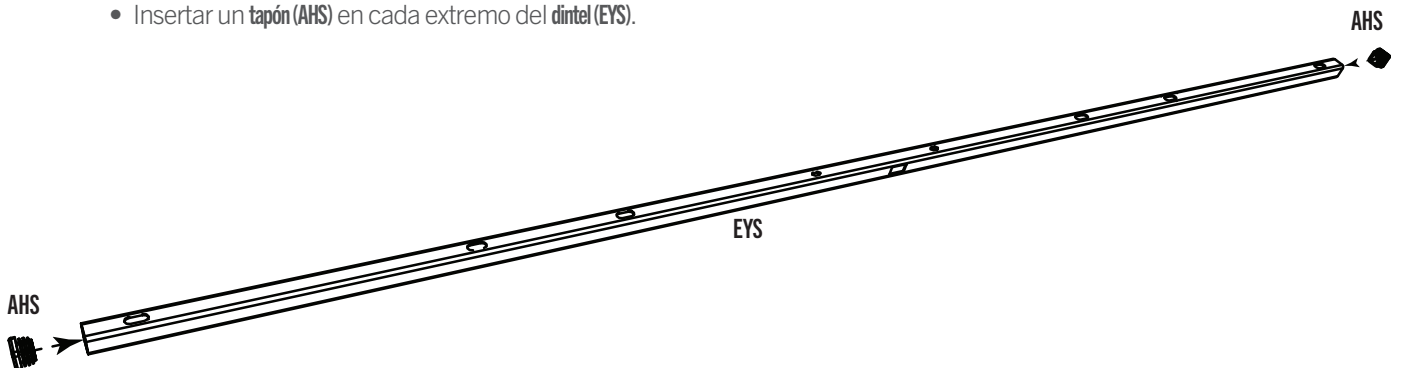

## SECTION 3 (CONTINUED) / SECTION 3 (SUITE) / SECCIÓN 3 (CONTINUACIÓN)

TOOLS AND HARDWARE REQUIRED / OUTILS ET QUINCAILLERIE REQUIS / INSTRUMENTAL Y HERRAJE REQUERIDOS

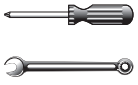

3/8 in/po  
(≈10 mm)

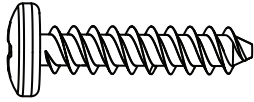

ADV (x6)

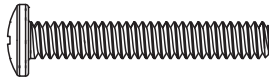

EYR (x2)

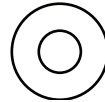

AEE (x2)



ADK (x2)

### 3.9

- Align the holes in the header with those in the gable.
- Aligner les trous dans le linteau avec ceux dans le pignon.
- Alinear los agujeros en el dintel con los de la fachada.



*The flat holes face away from the gable.  
Les trous plats font face de l'autre côté du pignon.  
Los agujeros lisos miran en contra de la fachada.*

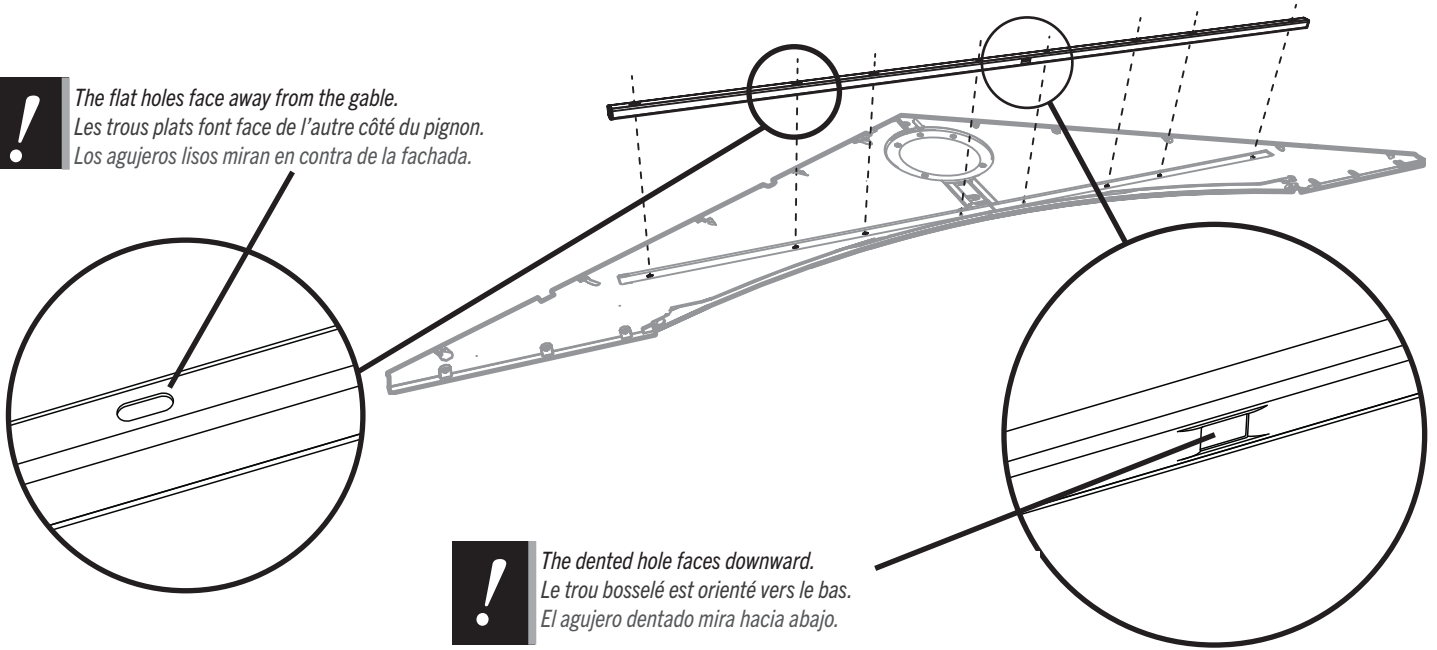

*The dented hole faces downward.  
Le trou bosselé est orienté vers le bas.  
El agujero dentado mira hacia abajo.*

### 3.10

- Secure with two (2) screws (EYR), two (2) washers (AEE), and two (2) nuts (ADK). **Do not overtighten.**
- Le fixer à l'aide de deux (2) vis (EYR), deux (2) rondelles (AEE), et deux écrous (ADK). **Ne pas trop serrer.**
- Sujeterlo con dos (2) tornillos (EYR), dos (2) rondanas (AEE), y dos tuercas (ADK). **No apretar demasiado.**

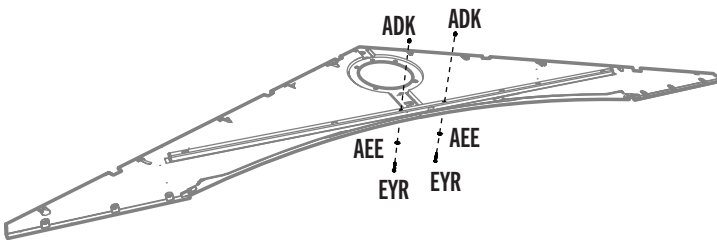

### 3.11

- Secure with six (6) more screws (ADV).
- Le fixer à l'aide de six (6) vis (ADV) de plus.
- Sujeterlo con seis (6) más tornillos (ADV).

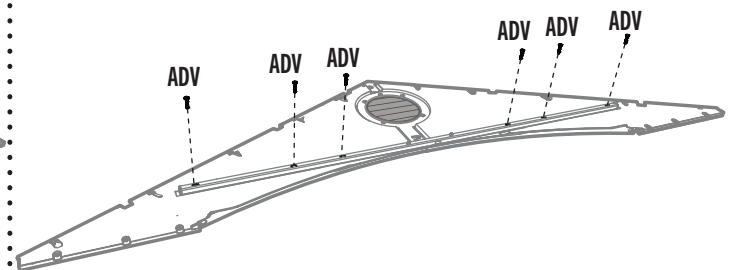

# 4

## LEFT DOOR ASSEMBLY / ASSEMBLAGE DE LA PORTE GAUCHE / ENSAMBLE DE LA PUERTA IZQUIERDA



### HARDWARE REQUIRED / QUINCAILLERIE REQUISE / HERRAJE REQUERIDO

Hardware Bags / Sacs de quincaillerie / Bolsas de herraje

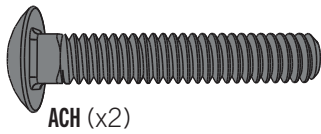

ACH (x2)



ADW (x1)

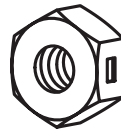

AAB (x2)

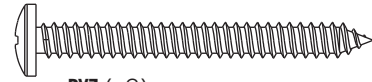

BYZ (x2)

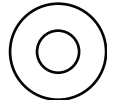

AEE (x3)

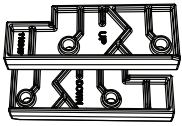

ENP (x2)



ENO (x4)



AEB (x2)

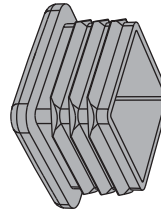

BBH (x1)

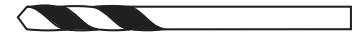

ARA (x1) 1/8 in/po (≈3 mm)

Parts / Pièces / Piezas

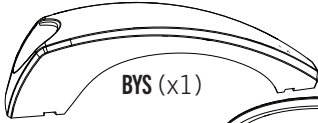

BYS (x1)



BYR (x1)

Parts / Pièces / Piezas

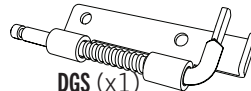

DGS (x1)

Upper / Supérieur / Superior

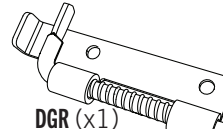

DGR (x1)

Lower / Inférieur / Inferior

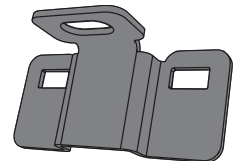

EOY (x1)



### PARTS REQUIRED / PIÈCES REQUISES / PIEZAS REQUERIDAS

Metal Parts / Pièces en métal / Piezas de metal



Top End / Extrémité supérieure / Extremo superior

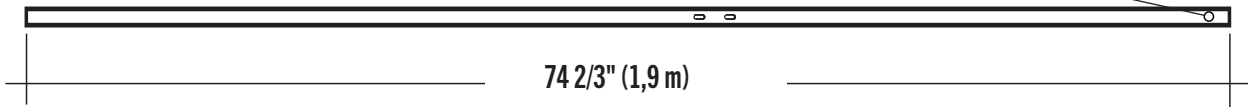

EDW (x1)

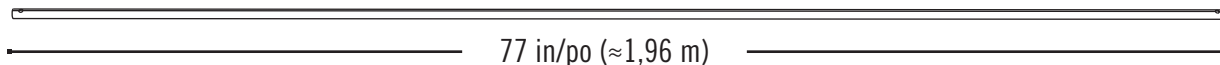
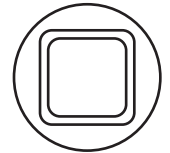

CRD (x1)

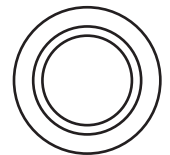

Plastic Parts / Pièces en plastique / Piezas de plástico

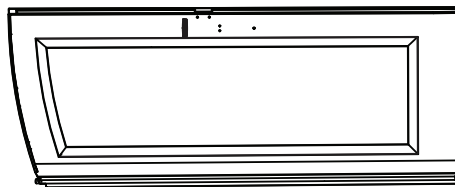

BDJ (x1)



### TOOLS REQUIRED (NOT INCLUDED—UNLESS INDICATED OTHERWISE\*) / OUTILS REQUIS (NON INCLUS—SAUF INDICATION CONTRAIRE\*) / INSTRUMENTAL REQUERIDO (NO INCLUIDO, SALVO INDICACIÓN CONTRARIA\*)

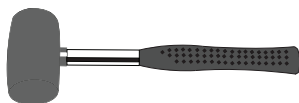

ARA (x1)  
1/8 in/po (≈3mm)

## ► SECTION 4 (CONTINUED) / SECTION 4 (SUITE) / SECCIÓN 4 (CONTINUACIÓN)

TOOLS AND HARDWARE REQUIRED / OUTILS ET QUINCAILLERIE REQUIS / INSTRUMENTAL Y HERRAJE REQUERIDOS

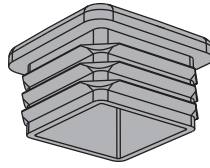

BBH (x1)

### 4.1

- Slide a **long tube (EDW)** into the hole in the **left door (BDJ)** until a few inches remain out of the door. **The end with the hole goes at the top.**
- Faites glisser le **tube grand (EDW)** à travers le trou de la **porte gauche (BDJ)** jusqu'à ce qu'il dépasse quelques pouces de la porte. **L'extrémité avec le trou va vers le haut.**
- Deslice el **tubo largo (EDW)** adentro del agujero en la **puerta izquierda (BDJ)** hasta que el tubo cuelgue unas pulgadas de la puerta. **El extremo con el agujero va al tope.**

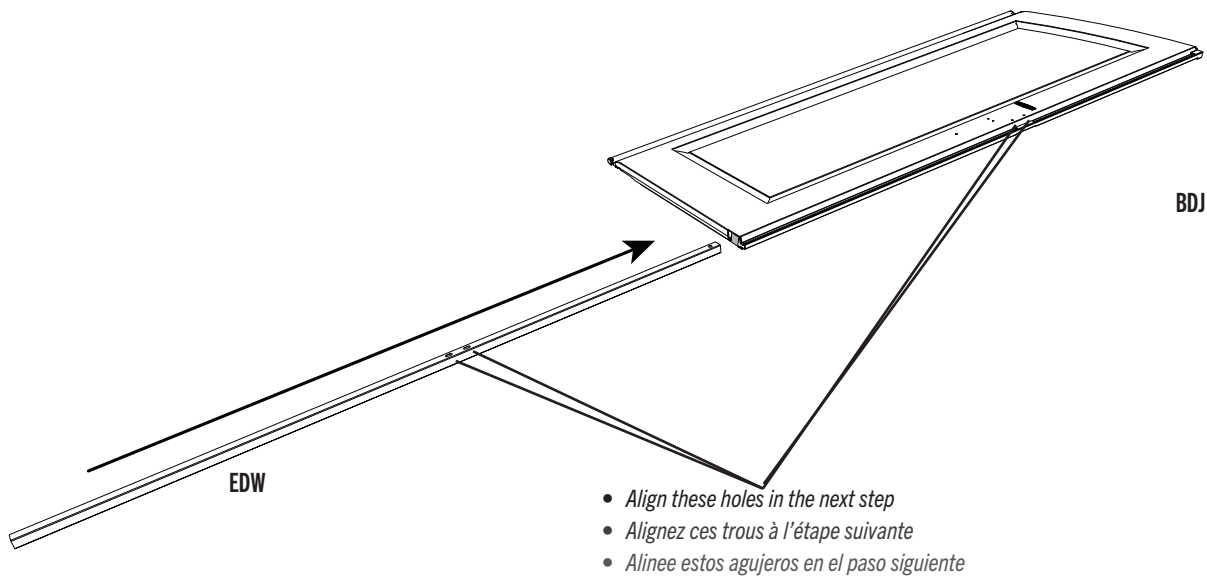

### 4.2

- Insert an **end cap (BBH)** into the end of the tube and finish inserting the tube until flush with bottom of door and the two holes in the tube align with those in the door.
- Insérez un **capuchon (BBH)** dans l'extrémité du tube et continuez d'insérer le tube jusqu'à ce qu'il soit à ras au bord inférieur de la porte et les deux trous dans le tube s'alignent avec ceux dans la porte.
- Inserte un **tapon (BBH)** adentro del extremo del tubo y siga con la inserción del tubo hasta que esté al ras del borde inferior de la puerta y los dos agujeros en el tubo se alineen con ellos en la puerta.

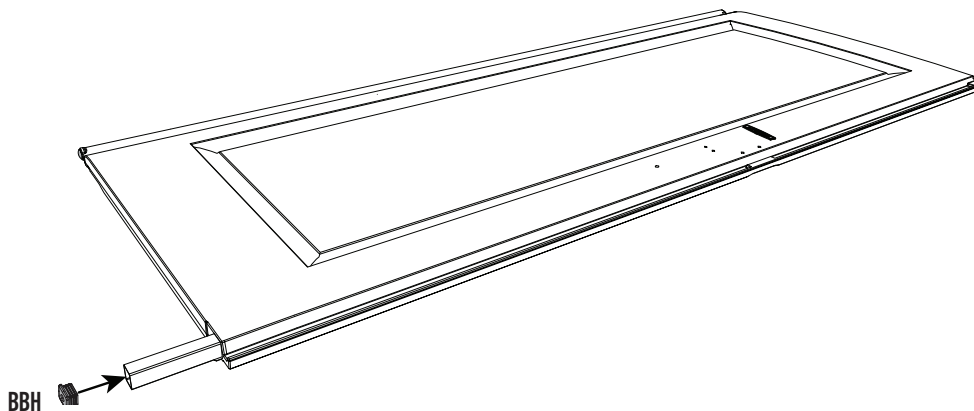

## SECTION 4 (CONTINUED) / SECTION 4 (SUITE) / SECCIÓN 4 (CONTINUACIÓN)

TOOLS AND HARDWARE REQUIRED / OUTILS ET QUINCAILLERIE REQUIS / INSTRUMENTAL Y HERRAJE REQUERIDOS



1/8 in/po  
(≈3 mm)  
ARA (x1)

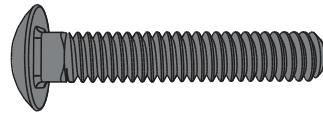

ACH (x2)

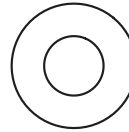

AEB (x2)

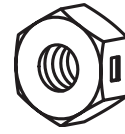

AAB (x2)

### 4.3

- Attach the **left latch bracket (EOY)** to the door using the hardware included. **Tighten only by hand at this point.**
- Attachez le **support gauche à loquet (EOY)** à la porte à l'aide de la quincaillerie incluse. **Serrez-les à la main seulement en ce moment.**
- Sujete el **soporte izquierdo para el pestañio (EOY)** a la puerta usando el herraje incluido. **Apriételes sólo a mano en este momento.**

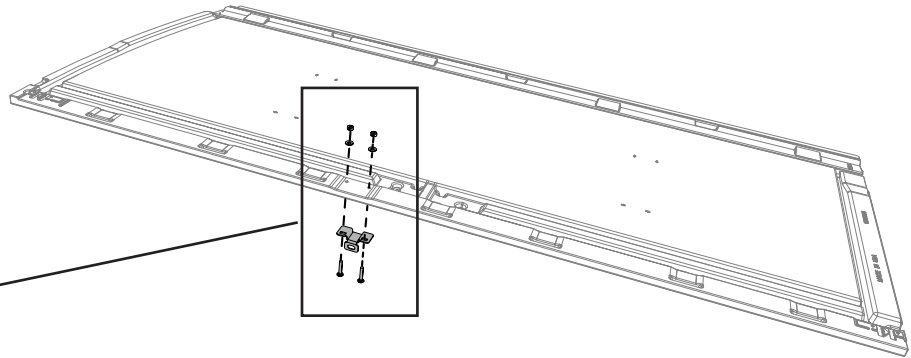
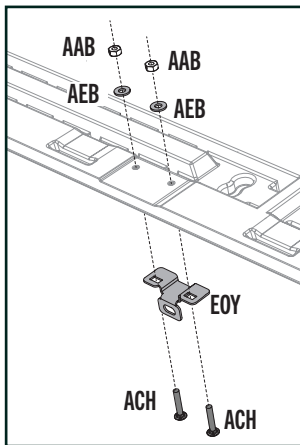

### 4.4

- Drill into the divots at the top and bottom of the door and into the tube inside but not all the way through the door. Use the **1/8" (3 mm) drill bit (ARA)** included.
- Percez les marques à la partie supérieure et inférieure de la porte et dedans le tube à l'intérieur mais pas à travers la porte entière. Utilisez le **foret de 3 mm (1/8 po) (ARA)** inclus.
- Taladre las marcas al tope y al fondo de la puerta y dentro del tubo adentro mas no por la puerta entera. Use la **broca de 3 mm (1/8 in.) (ARA)** incluida.

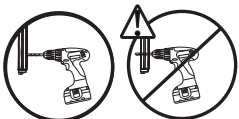
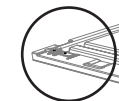

## ► SECTION 4 (CONTINUED) / SECTION 4 (SUITE) / SECCIÓN 4 (CONTINUACIÓN)

TOOLS AND HARDWARE REQUIRED / OUTILS ET QUINCAILLERIE REQUIS / INSTRUMENTAL Y HERRAJE REQUERIDOS

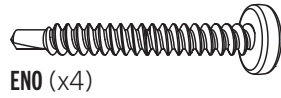

ENO (x4)

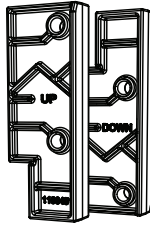

ENP (x2)

### 4.5

- Attach the **locks (DGR & DGS)** and **spacers (ENP)** to the top and bottom of the left door. **If the pins in the locks do not move freely, loosen the screws (ENO) just a tad.**
- Attachez les **verrous (DGR et DGS)** et les **pièces d'écartement (ENP)** à la partie supérieure et inférieure à la porte gauche. **Si les verrous ne se déplacent pas librement, deserre les vis (ENO) un petit peu.**
- Sujete los **pasadores (DGR y DGE)** y los **espaciadores (ENP)** al tope y al fondo de la Puerta izquierda. **Si los pasadores no se mueven libremente, afloje los tornillos (ENP) un poquito.**

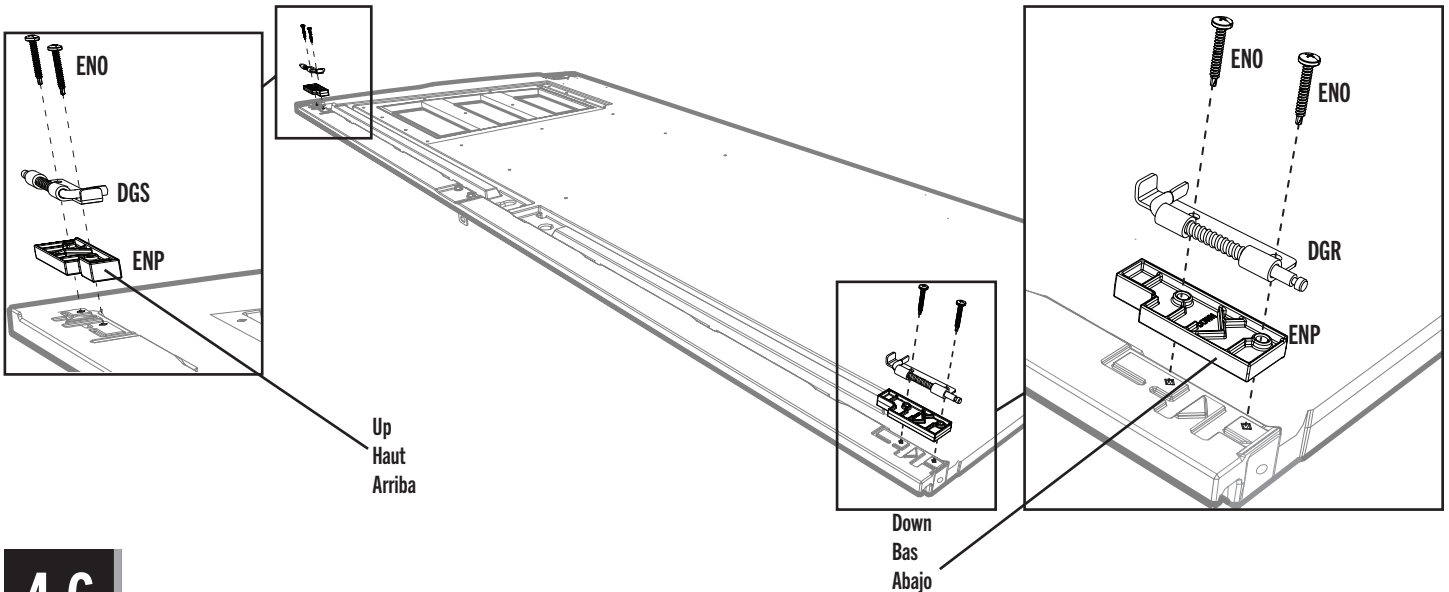

### 4.6

- Attach the two **handle pieces (BYR & BYS)** together as shown.
- Attachez les deux pièces de la **poignée (BYR et BYS)** comme illustré.
- Conecte las dos piezas del **picaporte (BYR y BYS)** como se muestra.

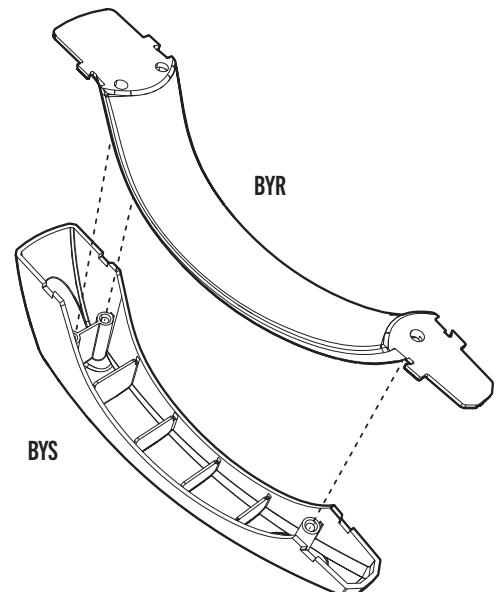



## ► SECTION 4 (CONTINUED) / SECTION 4 (SUITE) / SECCIÓN 4 (CONTINUACIÓN)

TOOLS AND HARDWARE REQUIRED / OUTILS ET QUINCAILLERIE REQUIS / INSTRUMENTAL Y HERRAJE REQUERIDOS

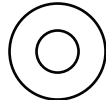
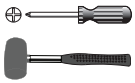

AEE (x3)

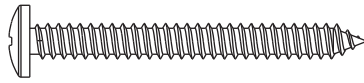

BYZ (x2)

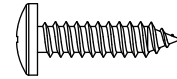

ADW (x1)

### 4.7

- Attach the handle to the door using the hardware included.
- Attachez la poignée à la porte à l'aide de la quincaillerie incluse.
- Sujete el picaporte a la puerta usando el herraje incluido.

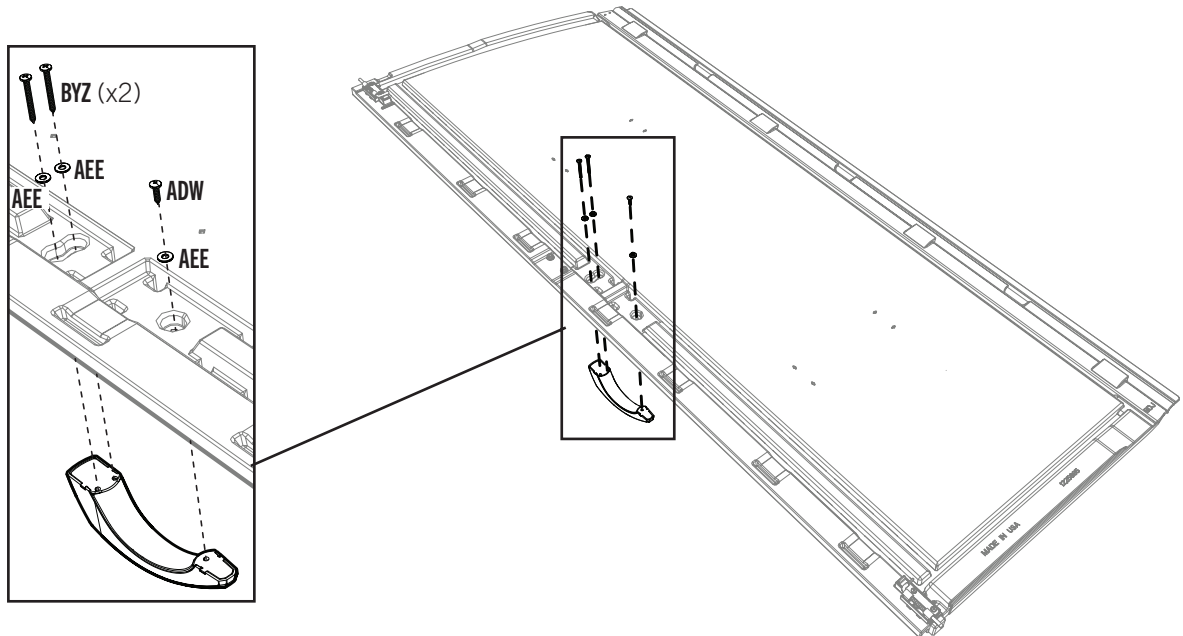

### 4.8

- Slide a **hinge tube (CRD)** into the hole in the door until a few inches remain out of the bottom.
- Faites glisser le **tube de charnière (CRD)** à travers le trou de la porte jusqu'à ce qu'il dépasse quelques pouces de la partie inférieure de la porte.
- Deslice un **tubo de bisagra (CRD)** adentro del agujero en la puerta hasta que el tubo cuelgue unas pulgadas de la parte inferior de la puerta.

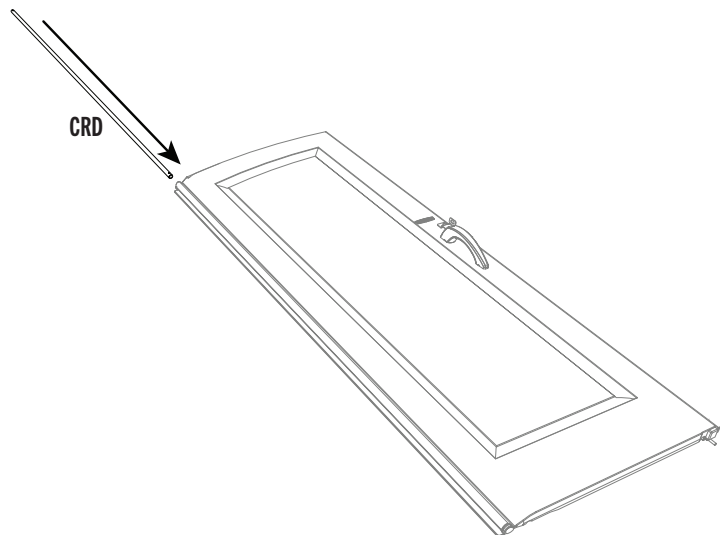

# 5

## RIGHT DOOR ASSEMBLY / ASSEMBLAGE DE LA PORTE DROITE / ENSAMBLAJE DE LA PUERTA DERECHA



### HARDWARE REQUIRED / QUINCAILLERIE REQUISE / HERRAJE REQUERIDO

Hardware Bags / Sacs de quincaillerie / Bolsas de herraje

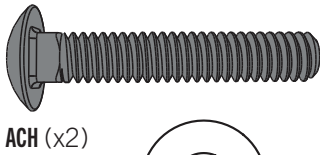

ACH (x2)

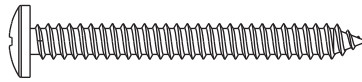

BYZ (x2)

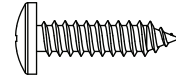

ADW (x1)

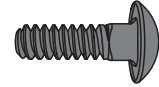

EPC (x2)



AEB (x2)

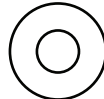

AEE (x3)

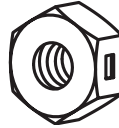

AAB (x2)

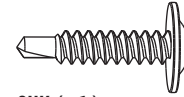

CHK (x1)



CXK (x2)

Parts / Pièces / Piezas

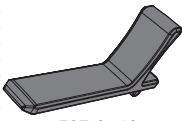

EOZ (x1)

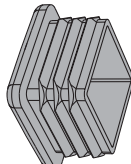

BBH (x1)

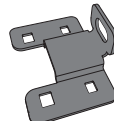

EPA (x1)

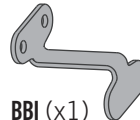

BBI (x1)



BYS (x1)



BYR (x1)



### PARTS REQUIRED / PIÈCES REQUISES / PIEZAS REQUERIDAS

Metal Parts / Pièces en métal / Piezas de metal



Top End / Extrémité supérieure / Extremo superior

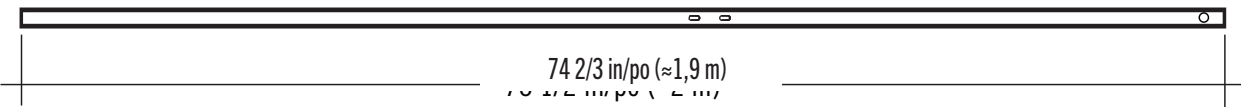

EDW (x1)

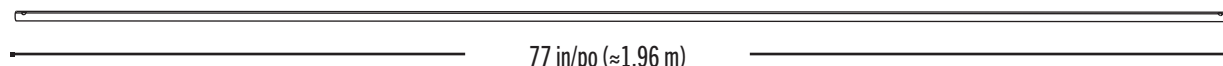

CRD (x1)

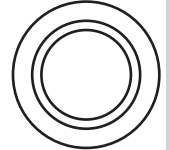
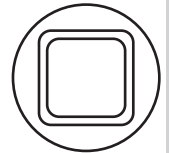

Plastic Parts / Pièces en plastique / Piezas de plástico



BDK (x1)



### TOOLS REQUIRED (NOT INCLUDED—UNLESS INDICATED OTHERWISE\*) / OUTILS REQUIS (NON INCLUS—SAUF INDICATION CONTRAIRE\*) / INSTRUMENTAL REQUERIDO (NO INCLUIDO, SALVO INDICACIÓN CONTRARIA\*)



7/16 in/po (≈11 mm)



3/8 in/po (≈10 mm)

## ► SECTION 5 (CONTINUED) / SECTION 5 (SUITE) / SECCIÓN 5 (CONTINUACIÓN)

TOOLS AND HARDWARE REQUIRED / OUTILS ET QUINCAILLERIE REQUIS / INSTRUMENTAL Y HERRAJE REQUERIDOS

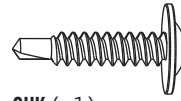

CHK (x1)

### 5.1

- Slide a **square tube (EDW)** into the hole in the **right door (BDK)** until a few inches remain out of the door. **The end with the hole goes at the top.**
- Faire glisser le **tube carré (EDW)** à travers le trou de la **porte droite (BDK)** jusqu'à ce qu'il dépasse de quelques centimètres de la porte. **L'extrémité avec le trou va en haut.**
- Deslizar el **tubo cuadrado (EDW)** adentro del agujero en la **puerta derecha (BDK)** hasta que el tubo cuelgue unas pulgadas de la puerta. **El extremo con el agujero va al tope.**

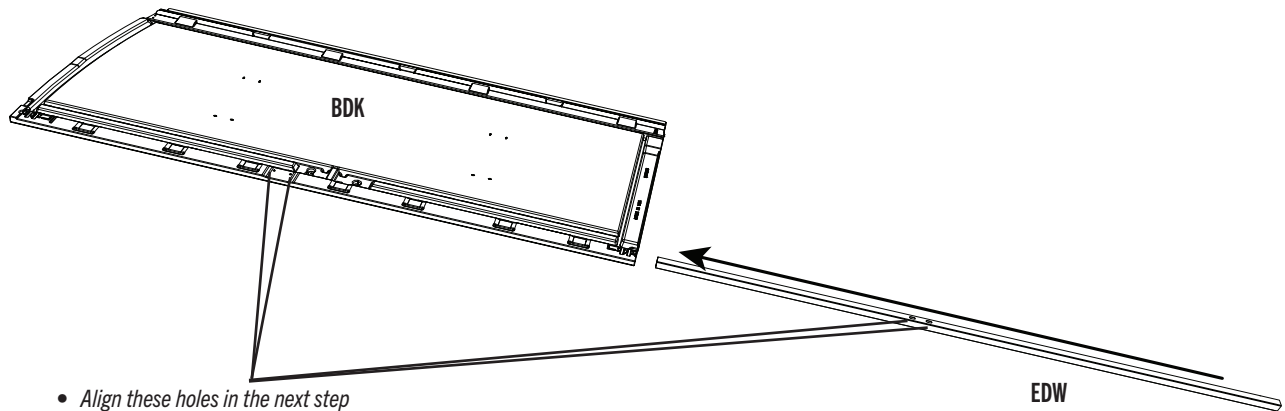

- *Align these holes in the next step*
- *Aligner ces trous à l'étape suivante*
- *Alinear estos agujeros en el paso siguiente*

### 5.2

- Insert an **end cap (BBH)** into the end of the tube, and finish inserting the tube until flush with bottom of door. Then, use a drill to insert a **self-drilling screw (CHK)** to hold it in place.
- Insérer un **capuchon (BBH)** dans l'extrémité du tube, et terminer d'insérer le tube jusqu'à ce qu'il soit à ras au bord inférieur de la porte. Puis, utiliser une perceuse pour insérer une **vis autotaraudeuse (CHK)** pour la maintenir en place.
- Insertar un **tapon (BBH)** en el extremo del tubo, y terminar de insertar el tubo hasta se alinee con la parte inferior de la puerta. Después, usar un taladro eléctrico para insertar un **tornillo auto-perforante (CHK)** para mantenerlo en su lugar.

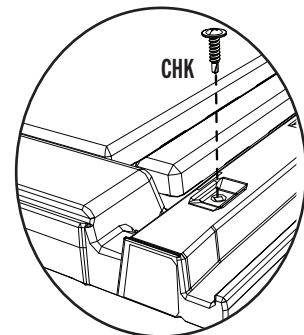
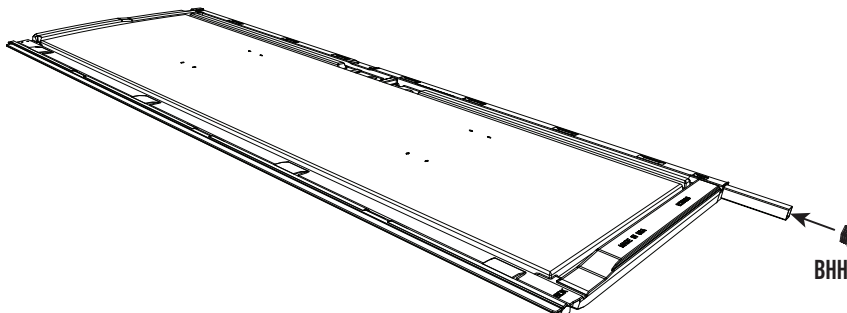

## ► SECTION 5 (CONTINUED) / SECTION 5 (SUITE) / SECCIÓN 5 (CONTINUACIÓN)

TOOLS AND HARDWARE REQUIRED / OUTILS ET QUINCAILLERIE REQUIS / INSTRUMENTAL Y HERRAJE REQUERIDOS



7/16 in/po  
(≈11 mm)



3/8 in/po  
(≈10 mm)

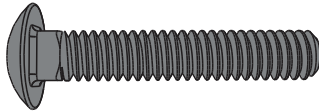

ACH (x2)

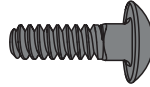

EPC (x2)

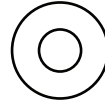

AEE (x2)

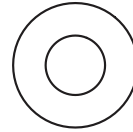

AEB (x2)

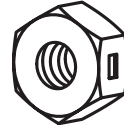

AAB (x2)



CXK (x2)

### 5.3

- Ensure the tube inside the door is flush with the bottom of the door. Attach the latch as shown.
- Veiller à ce que le tube dans la porte soit à ras au bord inférieur de la porte. Attacher le loquet comme indiqué.
- Asegurarse de que el tubo dentro de la puerta esté a ras del borde inferior de la puerta. Entonces, sujetar bien el pestañó como se muestra.

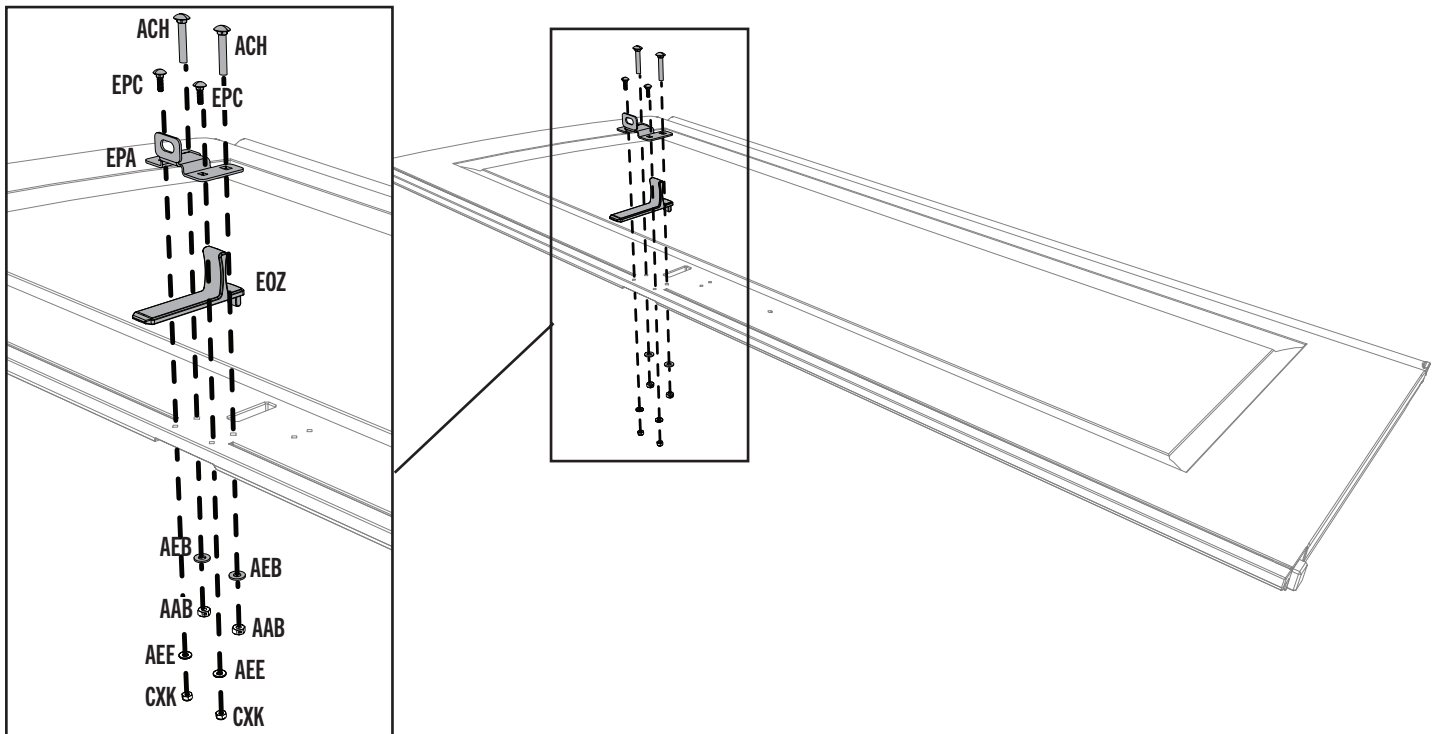

### 5.4

- Attach the two **handle pieces (BYR & BYS)** together as shown.
- Attacher les deux pièces de la **poignée (BYR et BYS)** comme indiqué.
- Conectar las dos piezas del **picaporte (BYR y BYS)** como se muestra.

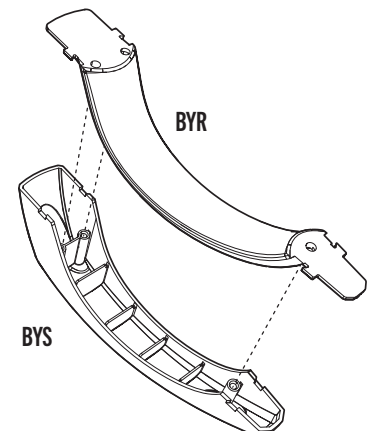

## ► SECTION 5 (CONTINUED) / SECTION 5 (SUITE) / SECCIÓN 5 (CONTINUACIÓN)

TOOLS AND HARDWARE REQUIRED / OUTILS ET QUINCAILLERIE REQUIS / INSTRUMENTAL Y HERRAJE REQUERIDOS

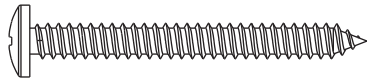

BYZ (x2)

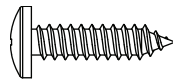

ADW (x1)

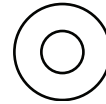

AEE (x1)

### 5.5

- Attach the handle as shown. **Tighten securely.**
- Bien attacher la poignée comme indiqué. **Bien serrer la quincaillerie.**
- Sujetar bien el picaporte como se muestra. **Apretar bien el herraje.**

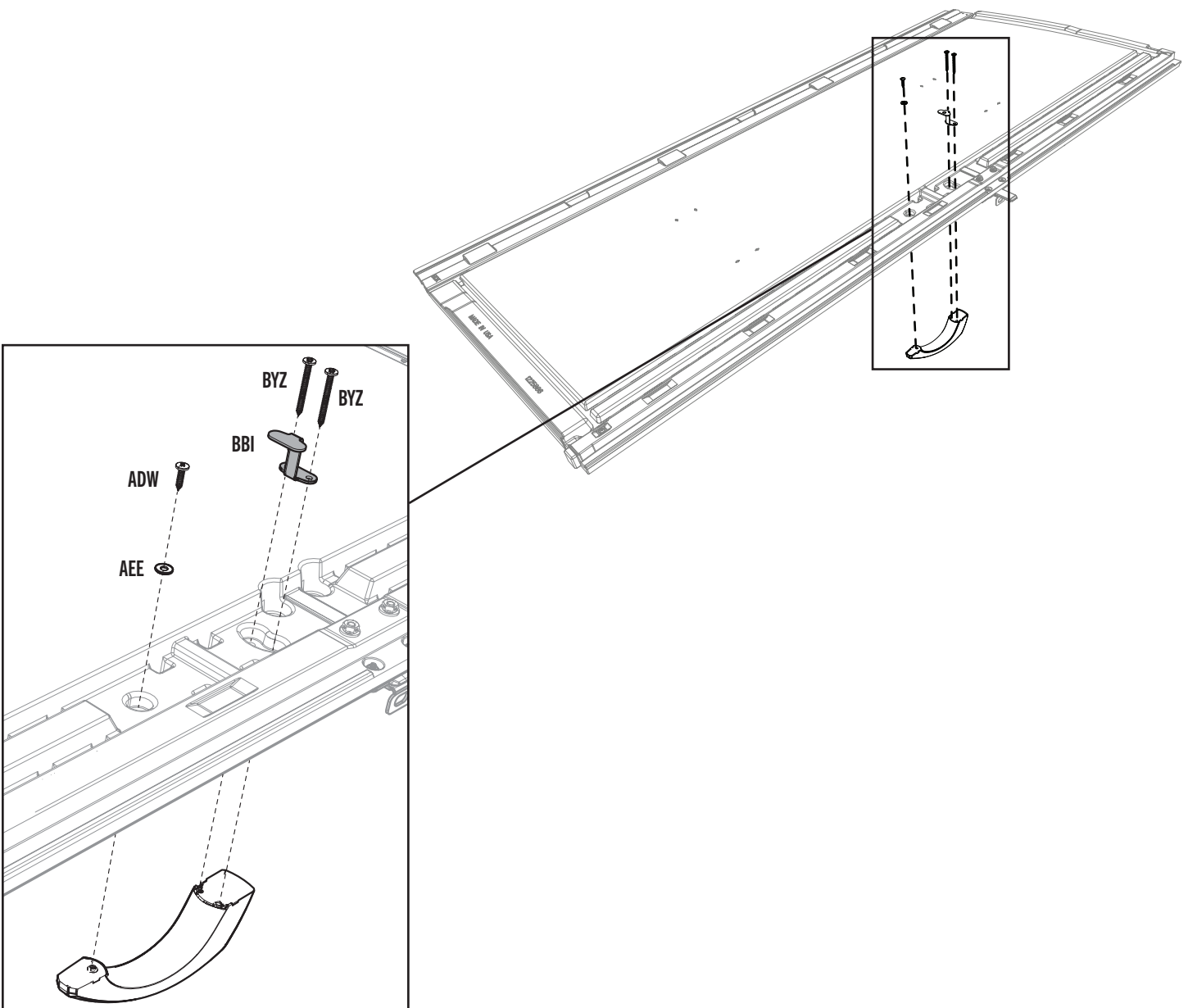

► SECTION 5 (CONTINUED) / SECTION 5 (SUITE) / SECCIÓN 5 (CONTINUACIÓN)

TOOLS AND HARDWARE REQUIRED / OUTILS ET QUINCAILLERIE REQUIS / INSTRUMENTAL Y HERRAJE REQUERIDOS



5.6

- Slide a **hinge tube (CRD)** into the hole in the door until a few inches remain out of the bottom.
- Faire glisser le **tube de articulation (CRD)** à travers le trou de la porte jusqu'à ce qu'il dépasse de quelques centimètres de la partie inférieure de la porte.
- Deslizar un **tubo de articulación (CRD)** adentro del agujero en la puerta hasta que el tubo cuelgue unas pulgadas de la parte inferior de la puerta.

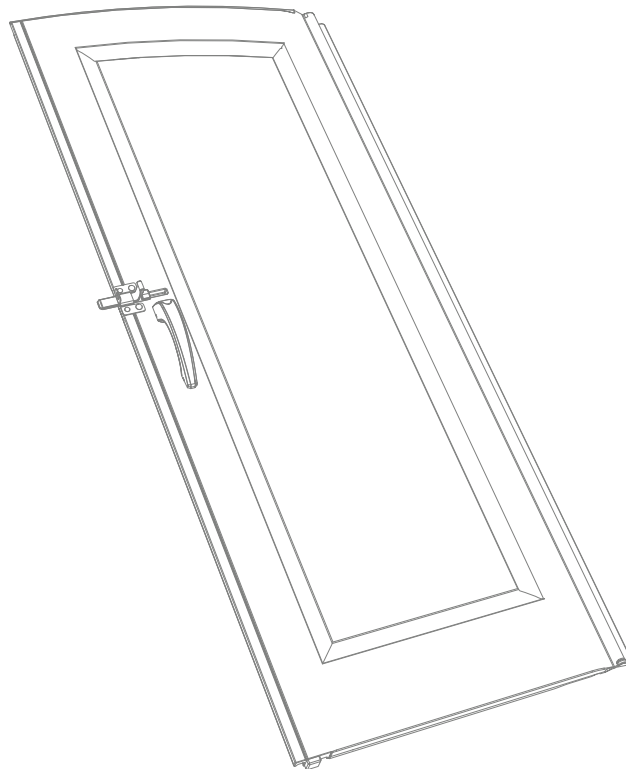
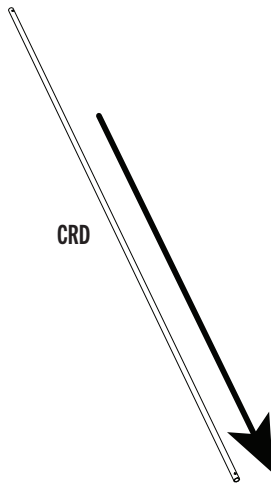

# 6

## FLOOR ASSEMBLY / ASSEMBLAGE DU PLANCHER / ENSAMBLAJE DEL PISO



### HARDWARE REQUIRED / QUINCAILLERIE REQUISE / HERRAJE REQUERIDO

Hardware Bag / Sac de quincaillerie / Bolsa de herraje

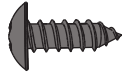

CWU (x32)



ADC (x1)

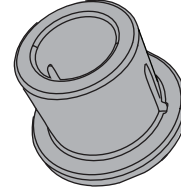

AHO (x2)

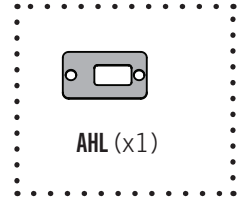

AHL (x1)



- These screws do not anchor the floor; they only hold the panels together.
- Ces vis n'ancrent pas le plancher ; ils ne servent que pour attacher les panneaux les uns aux autres.
- Estos tornillos no anclan el piso; sirven sólo para sujetar los paneles los unos a los otros.



### PARTS REQUIRED / PIÈCES REQUISES / PIEZAS REQUERIDAS

Plastic Parts/ Pièces en plastique / Piezas de plástico

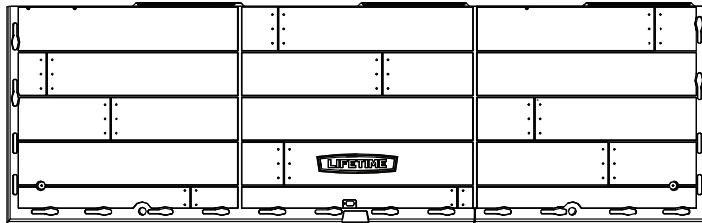

CUW (x2)

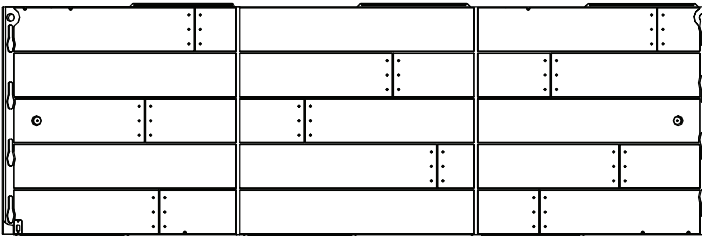

CUD (x4)

- *Unfold the floor panels before installing.*
- *Dépliez les panneaux de sol avant l'installation.*
- *Despliegue los paneles del suelo antes de instalar.*



TOOLS REQUIRED (NOT INCLUDED—UNLESS INDICATED OTHERWISE\*) / OUTILS REQUIS (NON INCLUS—SAUF INDICATION CONTRAIRE\*) / INSTRUMENTAL REQUERIDO (NO INCLUIDO, SALVO INDICACIÓN CONTRARIA\*)



## ► SECTION 6 (CONTINUED) / SECTION 6 (SUITE) / SECCIÓN 6 (CONTINUACIÓN)

TOOLS AND HARDWARE REQUIRED / OUTILS ET QUINCAILLERIE REQUIS / INSTRUMENTAL Y HERRAJE REQUERIDOS



### 6.1

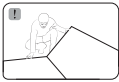

- Hold an **inner floor panel (CUD)** at an angle and slide the tabs along the edge underneath an **outer floor panel (CUW)**. The tabs interlock. Lay panel down flat.
- Poser un **panneau de plancher intérieur (CUD)** à un angle et faire glisser les languettes le long du bord au-dessus du **panneau de plancher extérieur (CUW)**. Les languettes s'enclenchent les uns les autres. L'étendre par terre.
- Colocar un **panel de piso interior (CUD)** a un ángulo y deslice las lengüetas a lo largo del borde debajo el **panel de piso exterior (CUW)**. Las lengüetas se entrelazan las unas con las otras. Aplanar el panel.

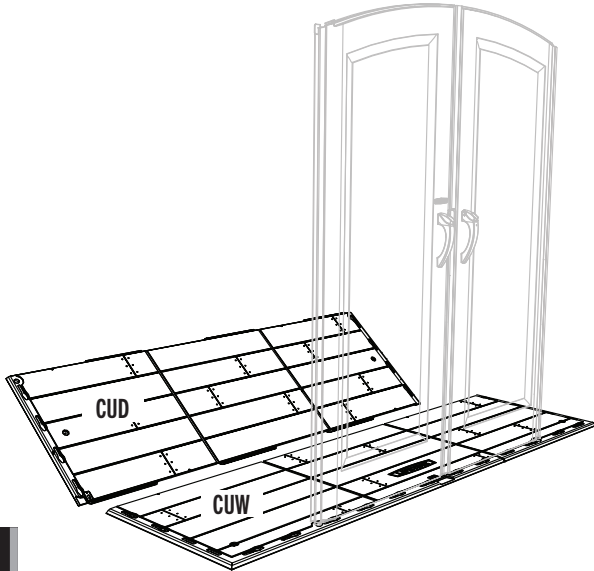

### 6.2

- Attach another **inner floor panel (CUD)** to the first **inner floor panel (CUD)**.
- Attacher un autre **panneau de plancher intérieur (CUD)** au premier **panneau de plancher intérieur (CUD)**.
- Fijar otro **panel de piso interior (CUD)** al primer **panel de piso interior (CUD)**.

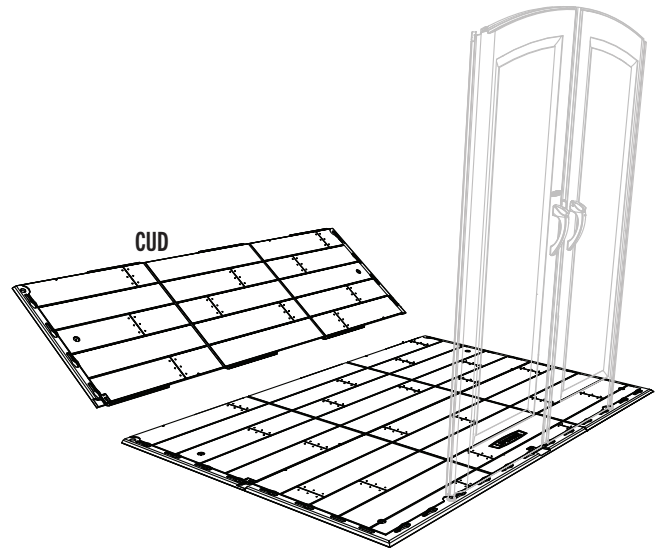

### 6.3

- Repeat the previous step twice.
- Répéter l'étape précédente deux fois.
- Repetir el paso anterior dos veces.

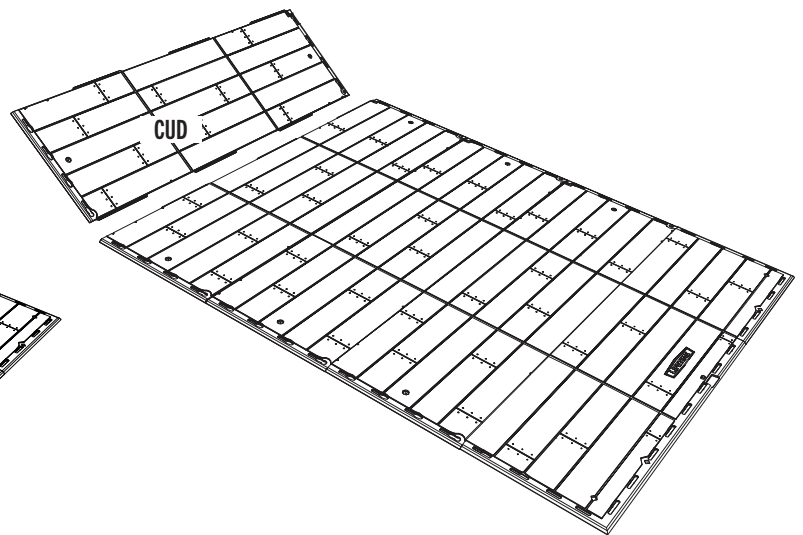
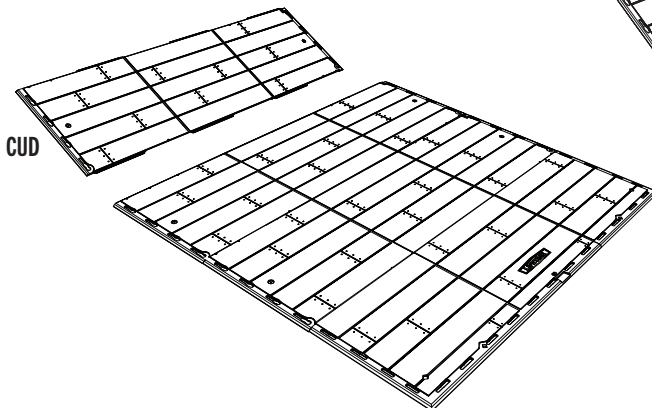



## ► SECTION 6 (CONTINUED) / SECTION 6 (SUITE) / SECCIÓN 6 (CONTINUACIÓN)

TOOLS AND HARDWARE REQUIRED / OUTILS ET QUINCAILLERIE REQUIS / INSTRUMENTAL Y HERRAJE REQUERIDOS

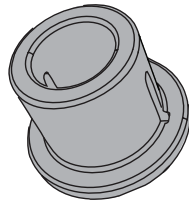

AHO (x2)

### 6.4

- Hold an **outer floor panel (CUW)** at an angle and slide the tabs along the edge underneath the last **inner floor panel (CUD)**. Lay panel down flat.
- Poser un **panneau de plancher extérieur (CUW)** à un angle et faire glisser les languettes le long du bord au-dessus du dernier **p de plancher intérieur (CUD)**. L'étendre par terre.
- Colocar un **panel de piso exterior (CUW)** a un ángulo y deslizar las lenguetas a lo largo del borde debajo el último **panel de piso interior (CUD)**. Aplanar el panel.

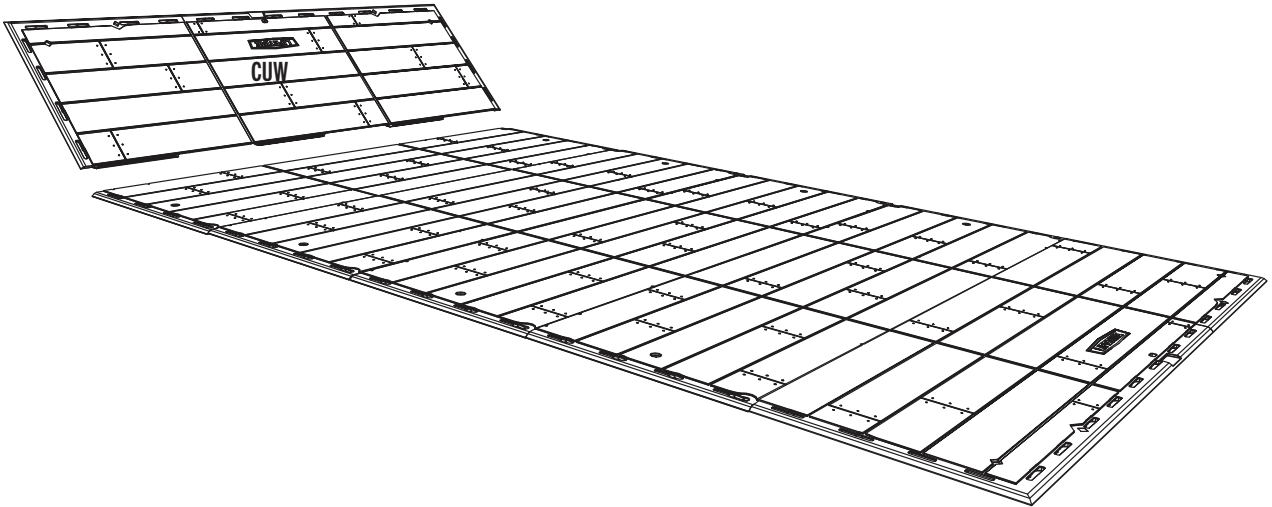

### 6.5

- Insert **bushings (AHO)** through the holes in the floor. **The slit in the bushing should face the front of the shed.**
- Insérer les **bagues (AHO)** à travers les trous dans le plancher. **La fente dans la bague doit donner sur le bord avant de l'abri.**
- Insertar los **casquillos (AHO)** a través de los agujeros en el piso. **La rendija en el casquillo debe dar hacia el borde delantero de la caseta.**

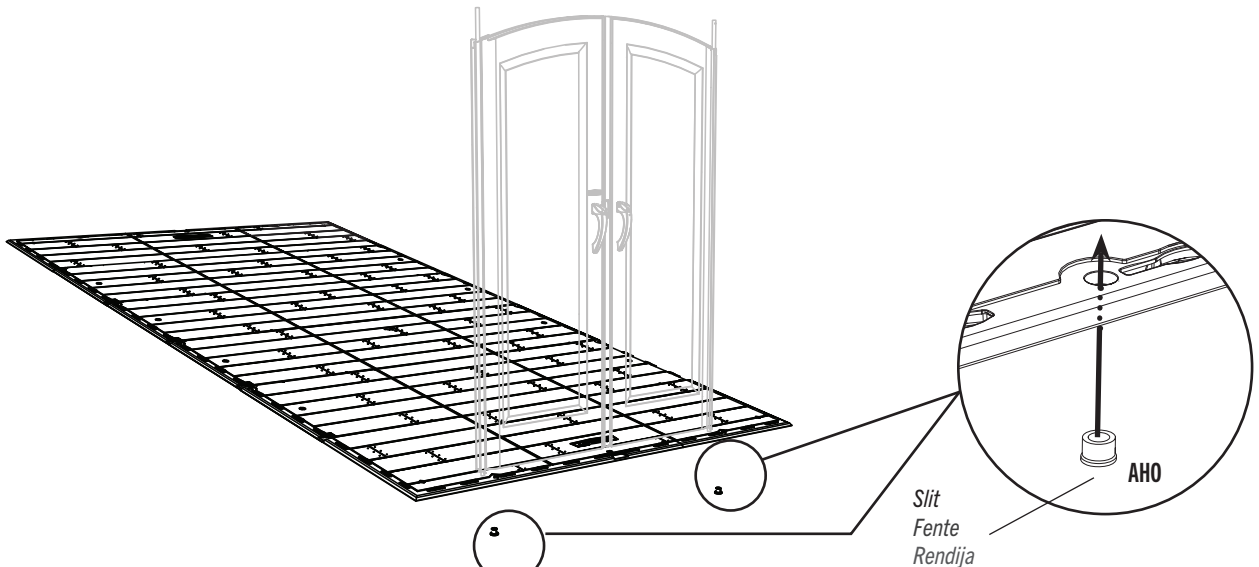

## ► SECTION 6 (CONTINUED) / SECTION 6 (SUITE) / SECCIÓN 6 (CONTINUACIÓN)

TOOLS AND HARDWARE REQUIRED / OUTILS ET QUINCAILLERIE REQUIS / INSTRUMENTAL Y HERRAJE REQUERIDOS

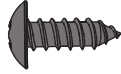

CWU (x2)



AHL (x1)

### 6.6

- Attach the **strike plate (AHL)** to the floor on the same side the bushings were installed.
- Attacher la **gâche (AHL)** au plancher sur le même côté que celui où les bagues ont été installées.
- Fijar la **placa de impacto (AHL)** al piso en el mismo lado donde se instalaron los casquillos.

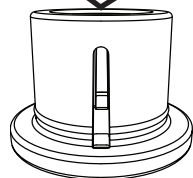
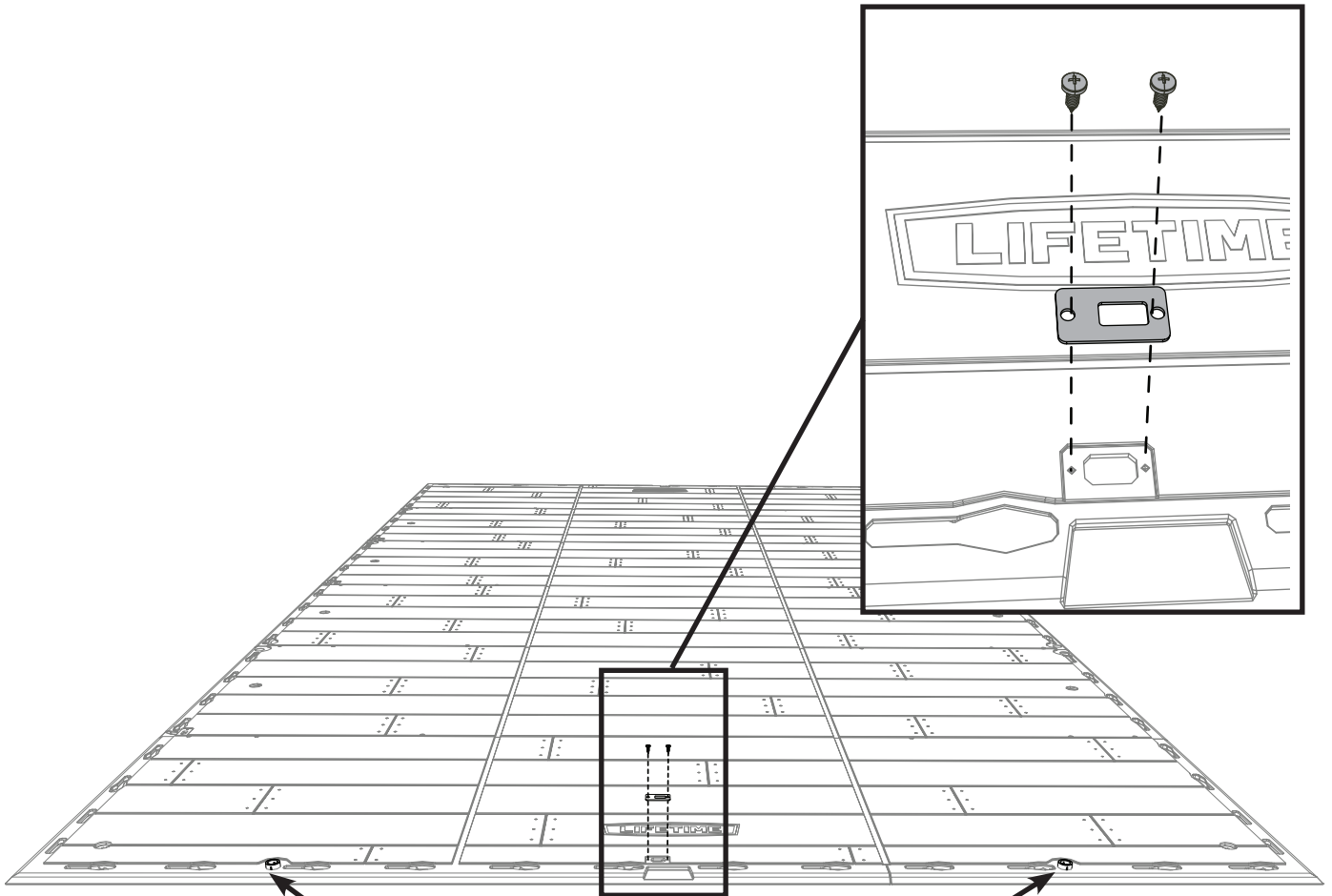

Bushings  
Bagues  
Casquillos

## ► SECTION 6 (CONTINUED) / SECTION 6 (SUITE) / SECCIÓN 6 (CONTINUACIÓN)

TOOLS AND HARDWARE REQUIRED / OUTILS ET QUINCAILLERIE REQUIS / INSTRUMENTAL Y HERRAJE REQUERIDOS

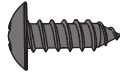

CWU (x30)



- *These screws do not anchor the floor; they only hold the Panels together.*
- *Ces vis n'ancrent pas le plancher ; ils ne servent que pour attacher les panneaux les uns aux autres.*
- *Estos tornillos no anclan el piso; sirven sólo para sujetar los paneles los unos a los otros.*

### 6.7

- Insert the **screws (CWU)** through the divots in the floor panels and into the tabs of the adjacent floor panels. (The divots are near the seams of the floor panels.)
- Insérer les **vis (CWU)** à travers les marques dans les panneaux de plancher et dans les languettes du panneaux de plancher contigu. (Les marques se trouvent près des jonctions des panneaux de plancher.)
- Insertar los **tornillos (CWU)** a través de las marcas en los paneles de piso y dentro de las lengüetas des los paneles de piso adyacentes. (Se encuentran las marcas cerca de las juntas de los paneles de piso.)

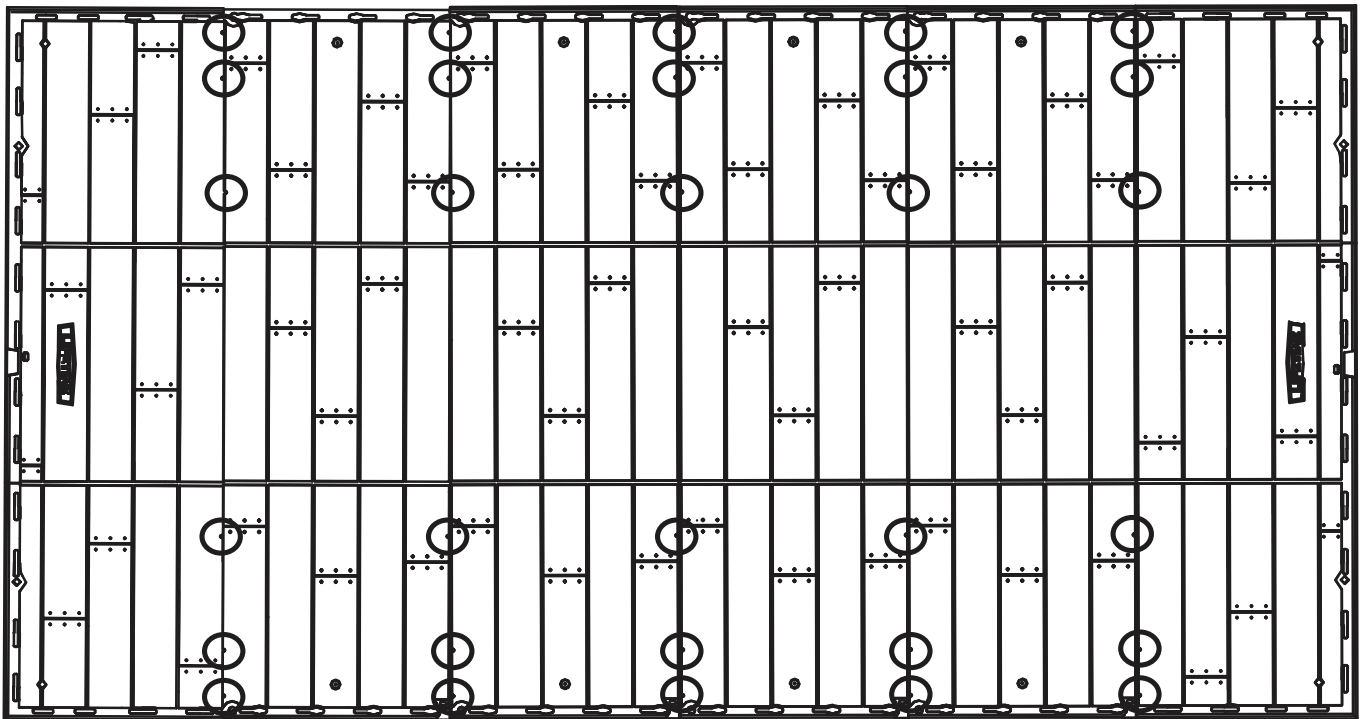

# 7

## WALL ASSEMBLY / ASSEMBLAGE DES MURS / ENSAMBLE DE LOS MUROS



### HARDWARE REQUIRED / QUINCAILLERIE REQUISE / HERRAJE REQUERIDO

Hardware Bag / Sac de quincaillerie / Bolsa de herraje

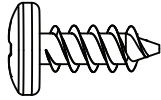

ADZ (x130)\*

- \* Not all hardware will be used in the section.
- \* La quincaillerie n'est pas utilisée au complet dans la section.
- \* No se utilizará todo el herraje en la sección.



### PARTS REQUIRED / PIÈCES REQUISES / PIEZAS REQUERIDAS

Metal Parts / Pièces en métal / Piezas de metal

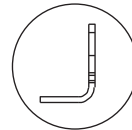
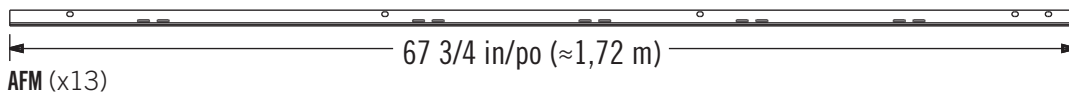

Plastic Parts / Pièces en plastique / Piezas de plástico

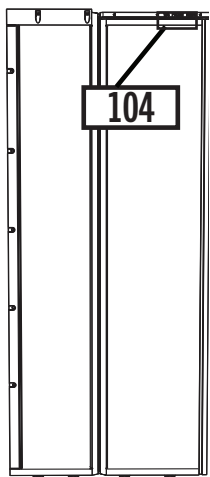

AGY (x1)

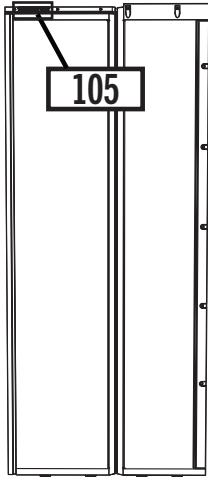

AGN (x1)

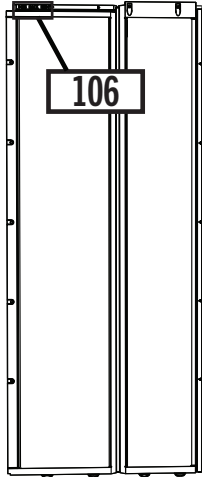

AGW (x1)

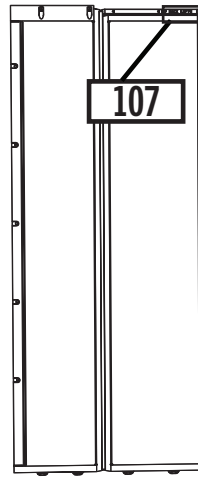

AGL (x1)

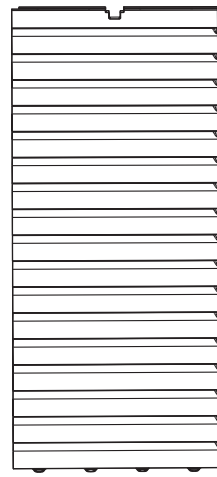

AHD (x11)

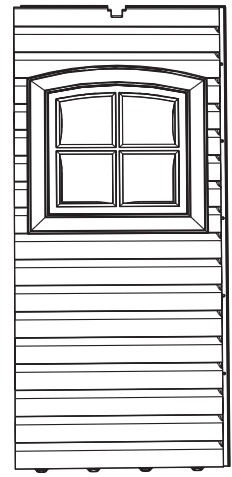

AHH (x1)

Parts / Pièces / Piezas



AIW (x1)



TOOLS REQUIRED (NOT INCLUDED—UNLESS INDICATED OTHERWISE\*) / OUTILS REQUIS (NON INCLUS—SAUF INDICATION CONTRAIRE\*) / INSTRUMENTAL REQUERIDO (NO INCLUIDO, SALVO INDICACIÓN CONTRARIA\*)

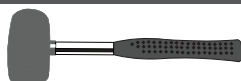

## SECTION 7 (CONTINUED) / SECTION 7 (SUITE) / SECCIÓN 7 (CONTINUACIÓN)

TOOLS AND HARDWARE REQUIRED / OUTILS ET QUINCAILLERIE REQUIS / INSTRUMENTAL Y HERRAJE REQUERIDOS

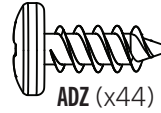
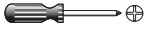

### 7.1

- Top end
- Extrémité supérieure
- Extremo superior



- No screw in top hole.
- Aucune vis dans le trou supérieur.
- Ningún tornillo en el agujero superior.

- Secure a **wall support channel (AFM)** at the middle of the notch on the nine (9) **wall panels (AHD)** using four (4) **screws (ADZ)** for each. The remaining two (2) wall panels will have the wall support channels installed in the next section.

- Fixez un **renfort de soutien mural (AFM)** au centre de l'encoche de chacun des neuf (9) **panneaux muraux (AHD)** à l'aide de quatre (4) **vis (ADZ)**. Les deux (2) panneaux muraux restants auront les chenaux de support muraux installés dans la section suivante.

- Asegure un **canal de soporte de pared (AFM)** en el centro de la muesca en los nueve (9) **paneles de pared (AHD)** utilizando cuatro (4) **tornillos (ADZ)** para cada uno. Los canales de apoyo para la pared de los dos (2) paneles restantes se instalarán en la siguiente sección.

- Notch
- Encoche
- Muesca

X9

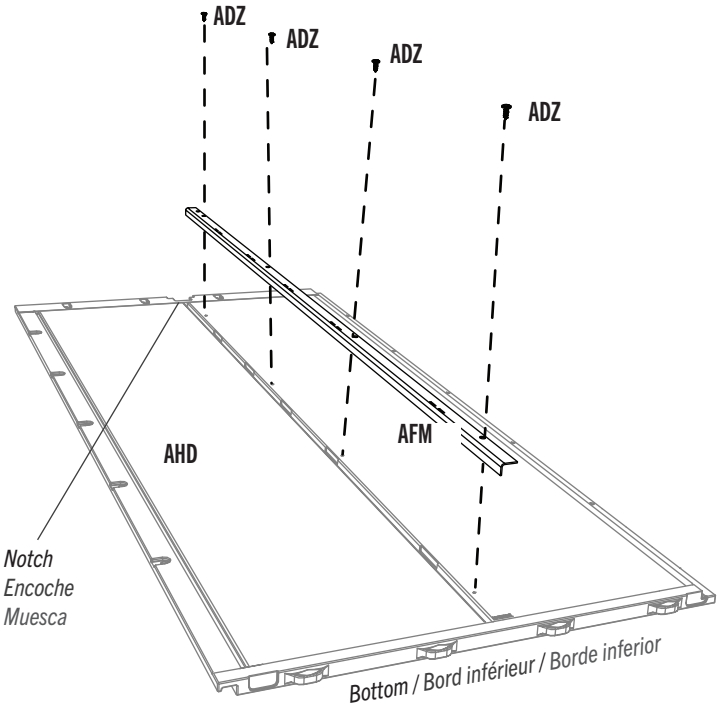

### 7.2

- Top end
- Extrémité supérieure
- Extremo superior



- No screw in top hole.
- Aucune vis dans le trou supérieur.
- Ningún tornillo en el agujero superior.

- Secure two **wall support channels (AFM)** at the outer edges on the one (1) **window panel (AHH)** using eight (8) **screws (ADZ)**.

- Fixez deux (2) **renforts de soutien mural (AFM)** sur le bord extérieur de une (1) **volet de fenêtre (AHH)** à l'aide de huit (8) **vis (ADZ)**.

- Asegure dos (2) **canales de soporte de pared (AFM)** en lo borde exterior de uno (1) **panele de ventana (AHH)** utilizando ocho (8) **tornillos (ADZ)**.

- Outer edges
- Bords extérieurs
- Bordes exteriores

X9

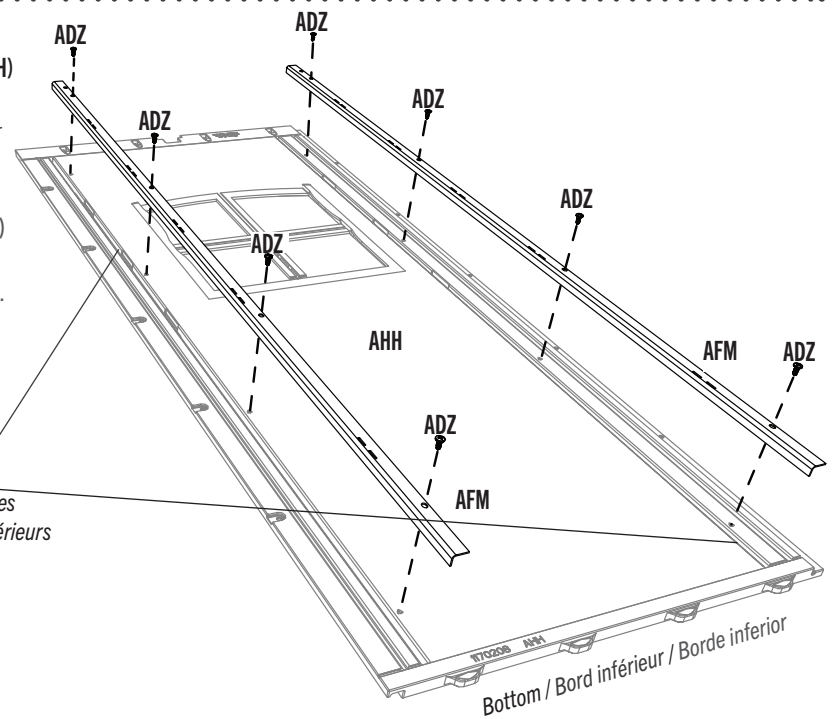

## SECTION 7 (CONTINUED) / SECTION 7 (SUITE) / SECCIÓN 7 (CONTINUACIÓN)

TOOLS AND HARDWARE REQUIRED / OUTILS ET QUINCAILLERIE REQUIS / INSTRUMENTAL Y HERRAJE REQUERIDOS

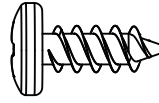
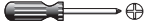

ADZ (x8)

### 7.3

- Top end
- Extrémité supérieure
- Extremo superior

- Insert a **wall support channel (AFM)** into the groove on the front-left corner **wall panel (AGN)** and secure using four (4) **screws (ADZ)**.
- Insérer un **support mural (AFM)** dans la rainure du **panneau mural avant gauche (AGN)** et bien le fixer à l'aide de quatre (4) **vis (ADZ)**.
- Insertar un **sopORTE mural (AFM)** en la ranura en el **panel mural delantero izquierdo (AGN)** y fijarlo bien usando cuatro (4) **tornillos (ADZ)**.

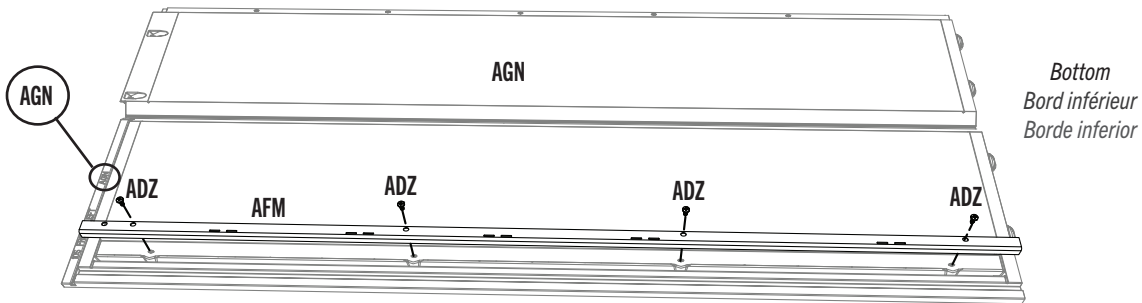

- No screw in top hole.
- Aucune vis dans le trou supérieur.
- Ningún tornillo en el agujero superior.

### 7.4

- Top end
- Extrémité supérieure
- Extremo superior

- Insert a **wall support channel (AFM)** into the groove in the front-right corner **wall panel (AGY)** and secure using four (4) **screws (ADZ)**.
- Insérer un **support mural (AFM)** dans la rainure du **panneau mural avant droit (AGN)** et bien le fixer à l'aide de quatre (4) **vis (ADZ)**.
- Insertar un **sopORTE mural (AFM)** en la ranura en el **panel mural delantero derecho (AGN)** y fijarlo bien usando cuatro (4) **tornillos (ADZ)**.

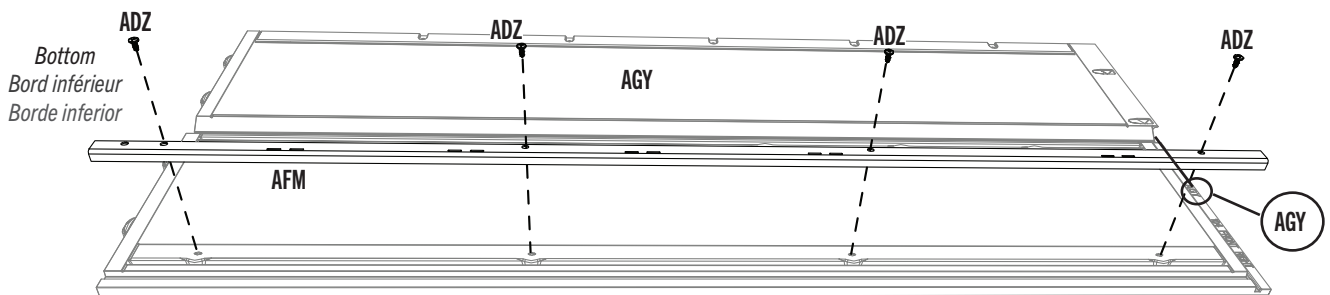

- No screw in top hole.
- Aucune vis dans le trou supérieur.
- Ningún tornillo en el agujero superior.

## ► SECTION 7 (CONTINUED) / SECTION 7 (SUITE) / SECCIÓN 7 (CONTINUACIÓN)

TOOLS AND HARDWARE REQUIRED / OUTILS ET QUINCAILLERIE REQUIS / INSTRUMENTAL Y HERRAJE REQUERIDOS



### 7.5

- Insert the two left-most tabs at the bottom of the **corner panel (AGY)** into the two right-most slots along the edge of the floor.
- Insérer les deux languettes gauches au bord inférieur du **panneau angulaire (AGY)** dans les deux rainures droites le long du bord du plancher.
- Insertar las lengüetas al borde inferior del **panel angular (AGY)** en las ranuras a lo largo del borde del piso.

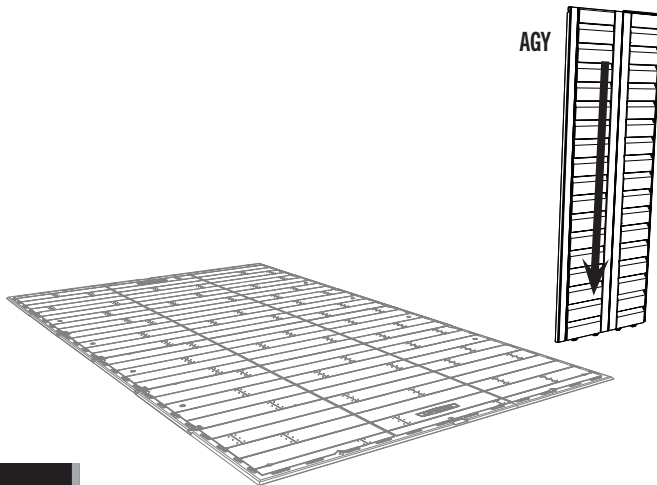

### 7.6

- Slide the panel to the left.
- Faire glisser le panneau à gauche.
- Deslizar el panel a la izquierda.

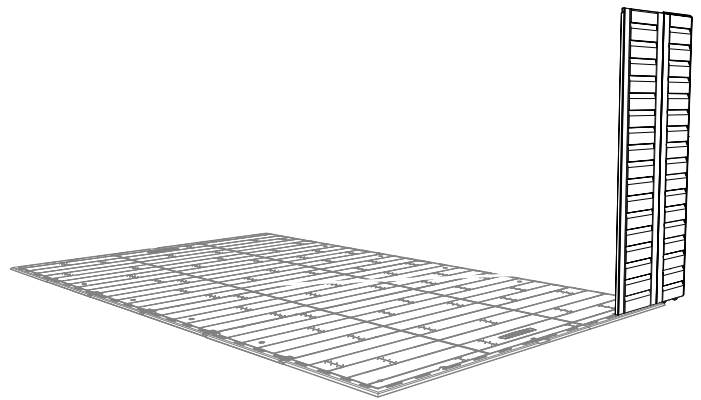

### 7.7

- Bend corner panel and pull down on the wall panel to insert the two remaining tabs. To help with insertion, place the **block (AIW)** under the floor panel directly under the tab being inserted. You should hear a “click” when the tab pops into place.
- Plier le panneau angulaire et tirer le panneau pour insérer les deux languettes restantes. Pour aider avec le montage, mettre le **bloque (AIW)** sous le panneau de plancher directement sous la languette à insérer.
- Doblar el panel angular y tirar para abajo el panel para insertar las dos lengüetas restantes. Para ayudar con el armado, deslizar el **bloque (AIW)** debajo el panel de piso directamente debajo la lengüeta a insertar. Se escucha un «clic» cuando la lengüeta se sienta en su lugar.



AIW (x1)

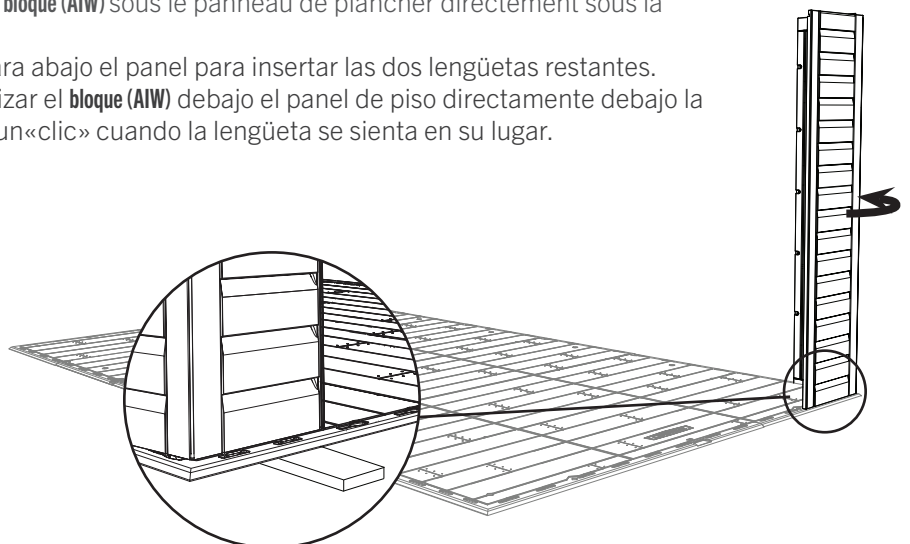

- Repeat this step for the second tab.
- Répéter ce processus pour la deuxième languette.
- Repetir este proceso para la segunda lengüeta.

## SECTION 7 (CONTINUED) / SECTION 7 (SUITE) / SECCIÓN 7 (CONTINUACIÓN)

TOOLS AND HARDWARE REQUIRED / OUTILS ET QUINCAILLERIE REQUIS / INSTRUMENTAL Y HERRAJE REQUERIDOS

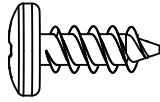
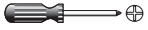

ADZ (x40)

### 7.8

- One at a time, insert the four tabs at the bottom of a **wall panel (AHD)** or **window wall panel (AHH)** into the next four slots along the edge of the floor. Slide the panels toward the front. **The window wall panels may be inserted on either side of the shed.** Secure the two panel together using five (5) **screws (ADZ)**. **Do not overtighten. The attachment points may have a thin membrane that the screws will puncture.**
- Un par un, insérer les quatre languettes au bord inférieur du **panneau mural (AHD)** ou **panneau mural pour la fenêtre (AHH)** dans les quatre rainures suivantes le long du bord du plancher. Faire glisser les panneaux vers la partie avant. **Les deux panneaux muraux pour la fenêtre s'insèrent soit le côté droit soit le côté gauche.** Attacher les deux panneaux l'un à l'autre à l'aide des cinq (5) **vis (ADZ)**. **Ne pas serrer excessivement les vis. Les points de fixation peuvent avoir une fine membrane que les vis perceront.**
- Uno por uno, insertar las cuatro lengüetas al borde inferior del **panel mural (AHD)** o **panel mural para la ventana (AHH)** en las cuatro ranuras siguientes a lo largo del borde del piso. Deslizar los paneles hacia al frente. **Se pueden insertar los paneles murales para la ventana en cualquiera de los dos lados.** Sujetar los dos paneles el uno al otro usando cinco (5) **tornillos (ADZ)**. **No apretar demasiado los tornillos. Los puntos de fijación pueden tener una membrana delgada que los tornillos perforarán.**

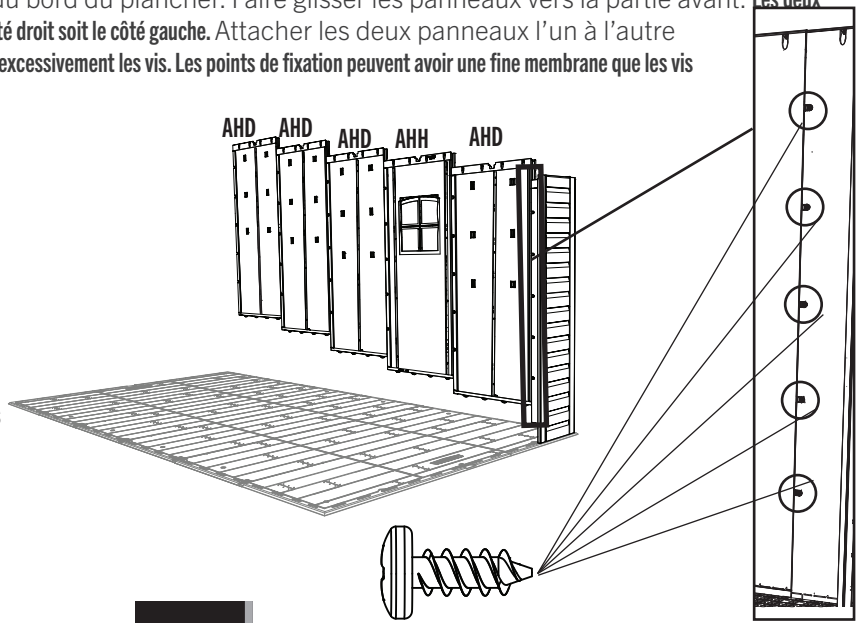

### 7.7

- Insert this corner **wall panel (AGW)** in the same way as the previous one.
- Insérer le **panneau angulaire (AGW)** de la même manière que le panneau angulaire précédent.
- Insertar este **panel angular (AGW)** de la misma manera que el panel angular anterior.



AIW (x1)

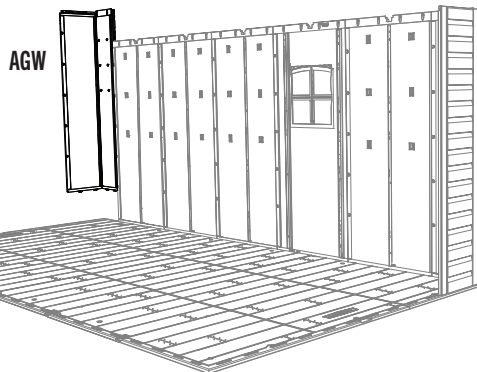

### 7.8

- Insert the two (2) **wall panels (AHD)** WITHOUT the wall support channels here. **Do not place window wall panels along the rear of the the shed.**
- Insérer les deux (2) **panneaux muraux (AHD)** SANS les renforts de soutien mural ici. **Ne pas insérer les deux panneaux muraux pour la fenêtre le long de bord arrière de l'abri.**
- Insertar los dos (2) **paneles murales (AHD)** SIN los canales de soporte de pared. **No insertar los paneles murales para la ventana a lo largo del borde trasero de la caseta.**

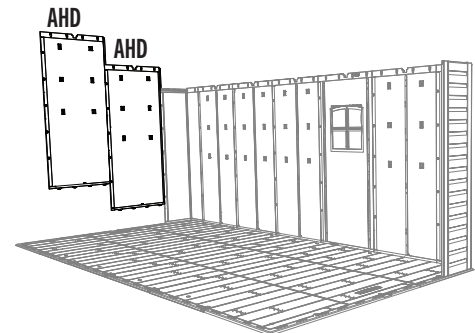





# PARTS IDENTIFIER / IDENTIFICATEUR DE PIÈCES / IDENTIFICADOR DE PIEZAS

CONTENTS OF BOX 1 / CONTENU DE LA BOÎTE 1 / CONTENIDO DE LA CAJA 1

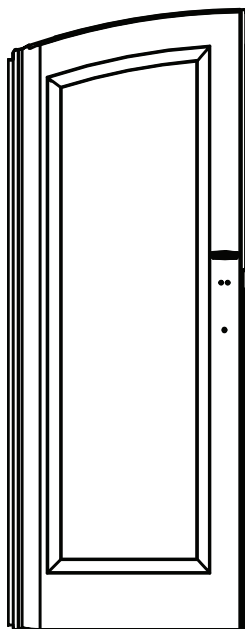

**BDJ** (x1)

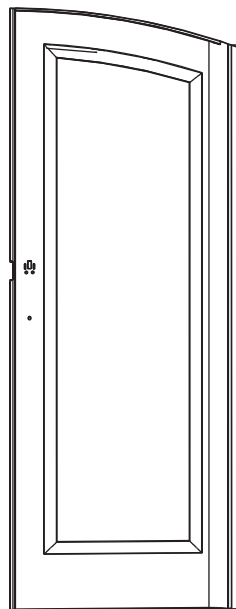

**BDK** (x1)

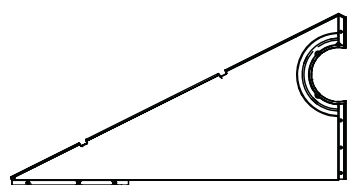

**AGI** (x1)

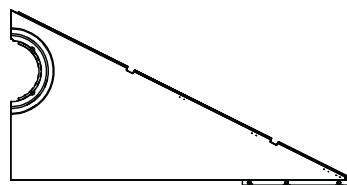

**AGH** (x1)

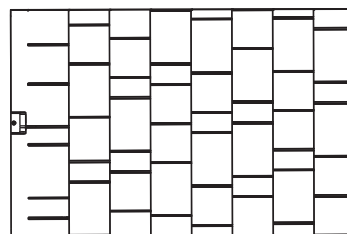

**AGQ** (x12)

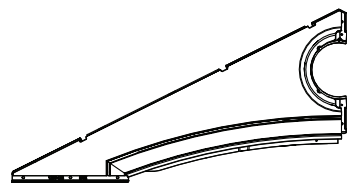

**EVZ** (x1)

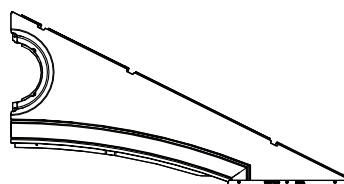

**EWA** (x1)

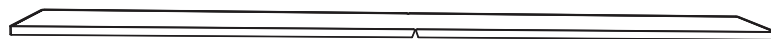

**AFV** (x1)

Remove this section for quick reference / Enlever cette section pour référence rapide / Retirar esta sección para referencia rápida



# PARTS IDENTIFIER / IDENTIFICATEUR DE PIÈCES / IDENTIFICADOR DE PIEZAS

CONTENTS OF METAL KIT 1 / CONTENU DU KIT EN MÉTAL 1 / CONTENIDO DEL JUEGO DE METAL 1



Remove this section for quick reference / Enlever cette section pour référence rapide / Retirar esta sección para referencia rápida

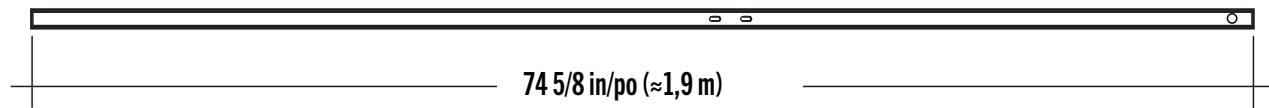

EDW (x2)

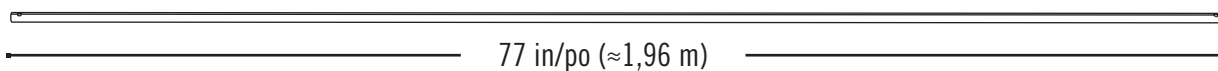

CRD (x2)

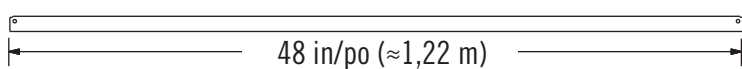

AFG (x2)

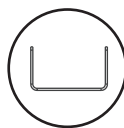

DSR (x4)

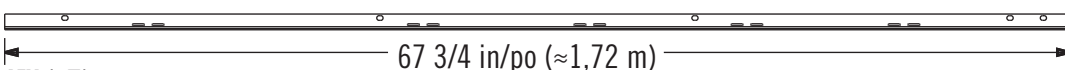

AFM (x7)

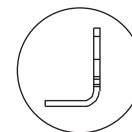

EYS (x1)

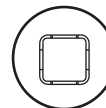

CONTENTS OF METAL KIT 1 / CONTENU DU KIT EN MÉTAL 1 / CONTENIDO DEL JUEGO DE METAL 1

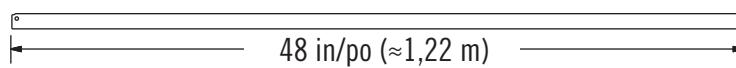

AFG (x3)

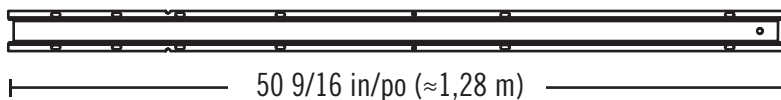
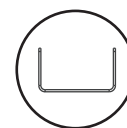

DSR (x6)

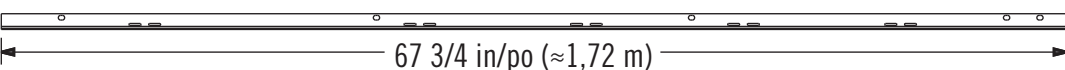

AFM (x8)

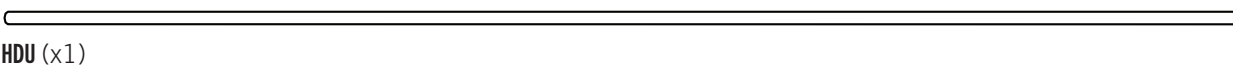
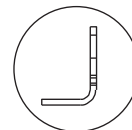

HDU (x1)



HDT (x1)



# PARTS IDENTIFIER / IDENTIFICATEUR DE PIÈCES / IDENTIFICADOR DE PIEZAS

CONTENTS OF BOX 2 / CONTENU DE LA BOÎTE 2 / CONTENIDO DE LA CAJA 2

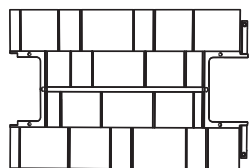

AFY (x5)

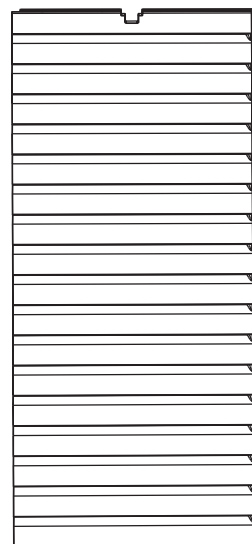

AHD (x6)

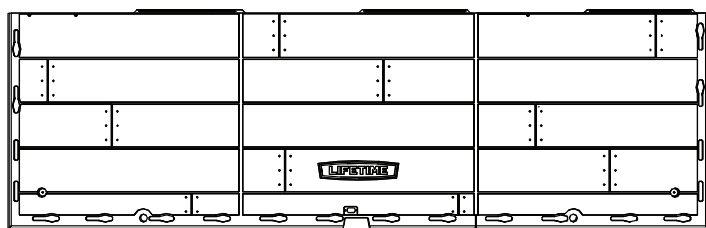

CUW (x2)

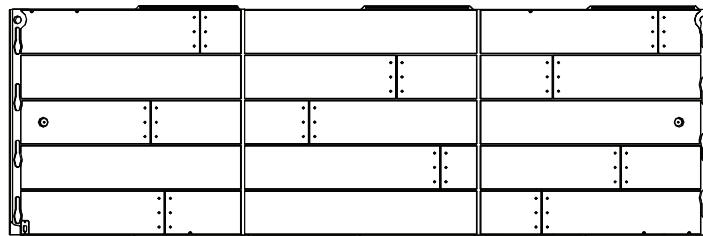

CUD (x4)

CONTENTS OF SMALL PARTS BOX / CONTENU DE LA BOÎTE DE PETITES PIÈCES / CONTENIDO DE LA CAJA DE PIEZAS PEQUEÑAS

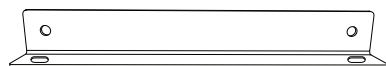

HDV (x2)

HARDWARE BAGS / SACS DE QUINCAILLERIE / BOLSAS DE HERRAJE



Remove this section for quick reference / Enlever cette section pour référence rapide / Retirar esta sección para referencia rápida



# PARTS IDENTIFIER / IDENTIFICATEUR DE PIÈCES / IDENTIFICADOR DE PIEZAS

CONTENTS OF BOX 3 / CONTENU DE LA BOÎTE 3 / CONTENIDO DE LA CAJA 3

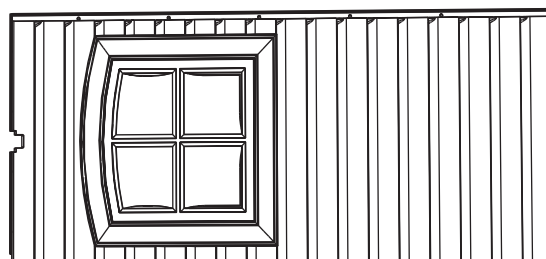

AHH (x1)

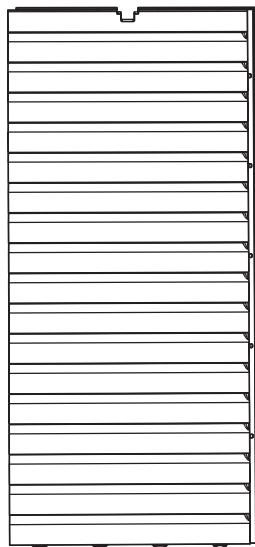

AHD (x5)

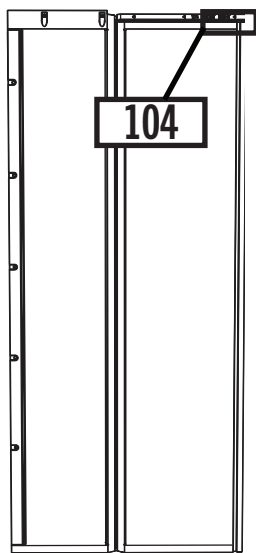

AGY (x1)

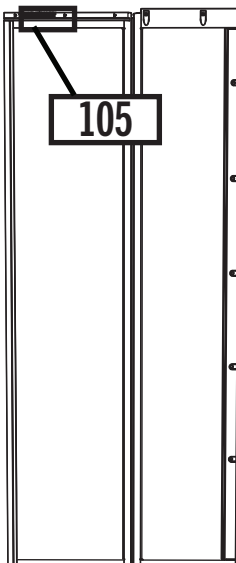

AGN (x1)

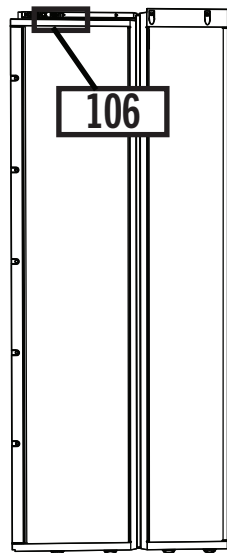

AGW (x1)

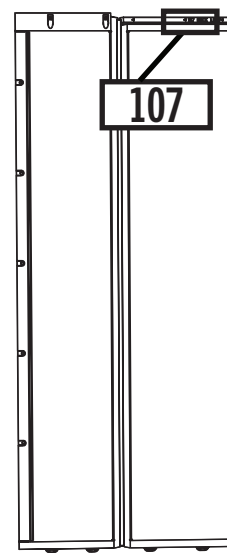

AGL (x1)

CONTENTS OF SMALL PARTS BOX / CONTENU DE LA BOÎTE DE PETITES PIÈCES / CONTENIDO DE LA CAJA DE PIEZAS PEQUEÑAS



AFL (x12)

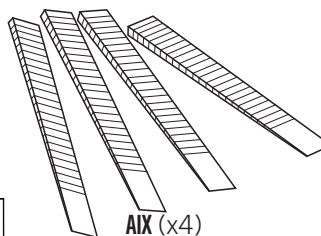

AIX (x4)

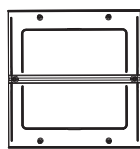

AHC (x6)

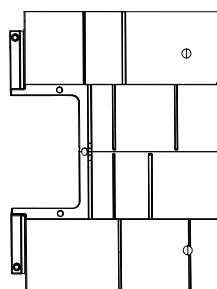

AGG (x1)

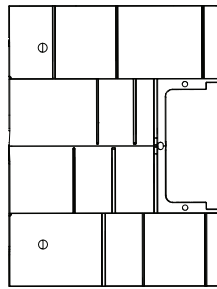

AFW (x1)



AIW (x1)

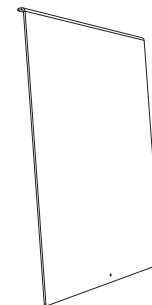

AHE (x1)

HARDWARE BAGS / SACS DE QUINCAILLERIE / BOLSAS DE HERRAJE



Remove this section for quick reference / Enlever cette section pour référence rapide / Retirar esta sección para referencia rápida

## ► SECTION 7 (CONTINUED) / SECTION 7 (SUITE) / SECCIÓN 7 (CONTINUACIÓN)

TOOLS AND HARDWARE REQUIRED / OUTILS ET QUINCAILLERIE REQUIS / INSTRUMENTAL Y HERRAJE REQUERIDOS

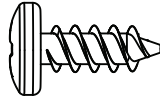

ADZ (x35)

### 7.9

- Insert this corner **wall panel (AGL)** in the same way as the previous one.
- Insérer le **panneau angulaire (AGL)** de la même manière que le panneau angulaire précédent.
- Insertar este **panel angular (AGL)** de la misma manera que el panel angular anterior.

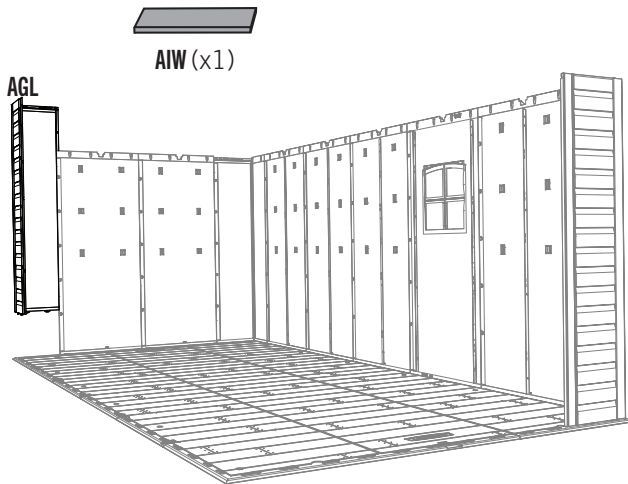

### 7.10

- Insert these wall panels in the same way as the previous ones.
- Insérer ces panneaux muraux de la même manière que les panneaux précédents.
- Insertar estos paneles murales de la misma manera que los paneles anteriores.

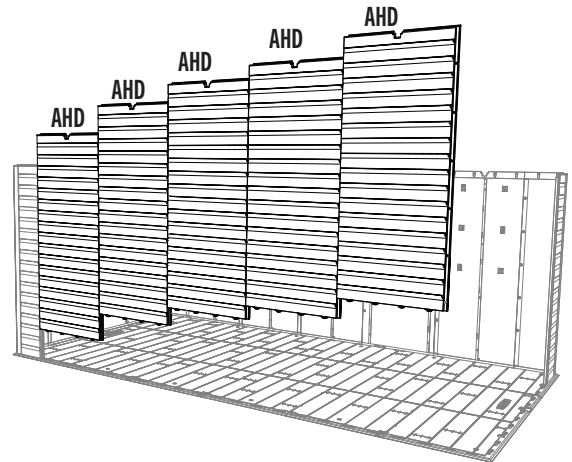

### 7.11

- Insert this corner **wall panel (AGN)** in the same way as the previous one.
- Insérer le **panneau angulaire (AGN)** de la même manière que le panneau angulaire précédent.
- Insertar este **panel angular (AGN)** de la misma manera que el panel angular anterior.

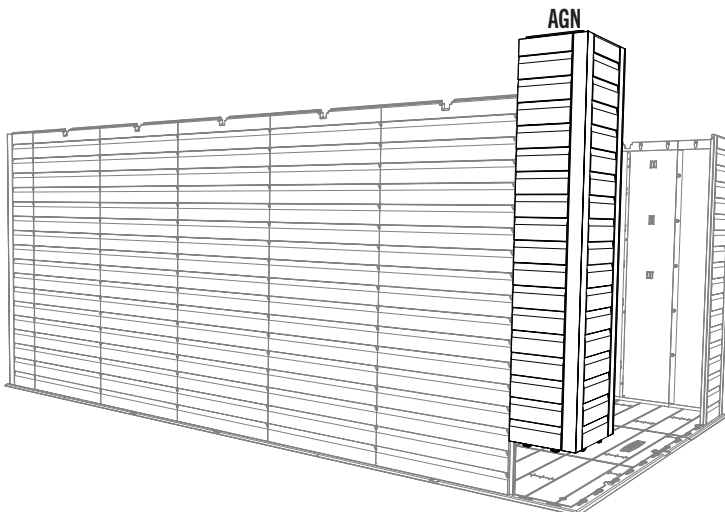

AIW (x1)

# 8

## SHELVING INSTALLATION / INSTALLATION DU RAYONNAGE / INSTALACIÓN DE LA ESTANERÍA



### HARDWARE REQUIRED / QUINCAILLERIE REQUISE / HERRAJE REQUERIDO

Hardware Bag / Sac de quincaillerie / Bolsa de herraje

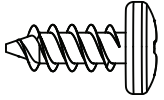

ADZ (x16)

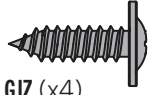

GJZ (x4)

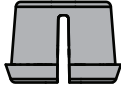

FEX (x4)

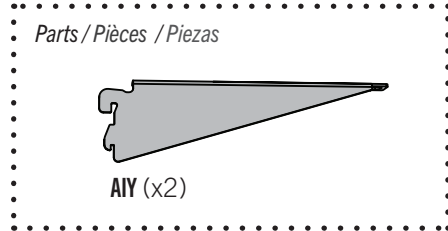

Parts / Pièces / Piezas

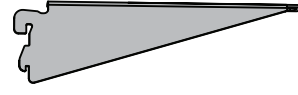

AIY (x2)



### PARTS REQUIRED / PIÈCES REQUISES / PIEZAS REQUERIDAS

Metal Parts / Pièces en métal / Piezas de metal

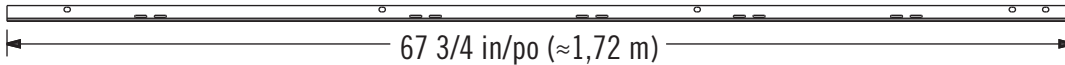

AFM (x2)

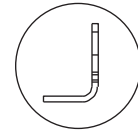

HDU (x1)

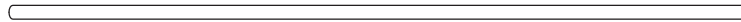

HDT (x1)

CONTENTS OF SMALL PARTS BOX / CONTENU DE LA BOÎTE DE PETITES PIÈCES / CONTENIDO DE LA CAJA DE PIEZAS PEQUEÑAS



HDV (x2)

Plastic Parts / Pièces en plastique / Piezas de plástico

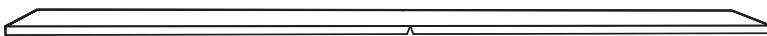

AFV (x1)



TOOLS REQUIRED (NOT INCLUDED—UNLESS INDICATED OTHERWISE\*) / OUTILS REQUIS (NON INCLUS—SAUF INDICATION CONTRAIRE\*) / INSTRUMENTAL REQUERIDO (NO INCLUIDO, SALVO INDICACIÓN CONTRARIA\*)



## ► SECTION 8 (CONTINUED) / SECTION 8 (SUITE) / SECCIÓN 8 (CONTINUACIÓN)

TOOLS AND HARDWARE REQUIRED / OUTILS ET QUINCAILLERIE REQUIS / INSTRUMENTAL Y HERRAJE REQUERIDOS

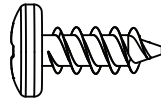

ADZ (x8)

### 8.1

- The right **wall/shelf support channel (AFM)** goes in the slot directly under the notch in the wall panel. The left wall support channel goes in the slot to the right of the notch in the wall panel.
- Le **canal de support du mur/étagère (AFM)** droit s'attache dans la rainure directement sous l'encoche dans le panneau mural. Le canal de support du mur/étagère gauche s'attache dans la rainure à la droite de l'encoche du panneau mural.
- El **canal de soporte para la pared/estante (AFM)** derecho se sujeta dentro de la ranura directamente debajo la muesca en el panel de pared. El canal de soporte para la pared izquierdo se sujeta dentro de la ranura a la derecha de la muesca en el panel de pared.

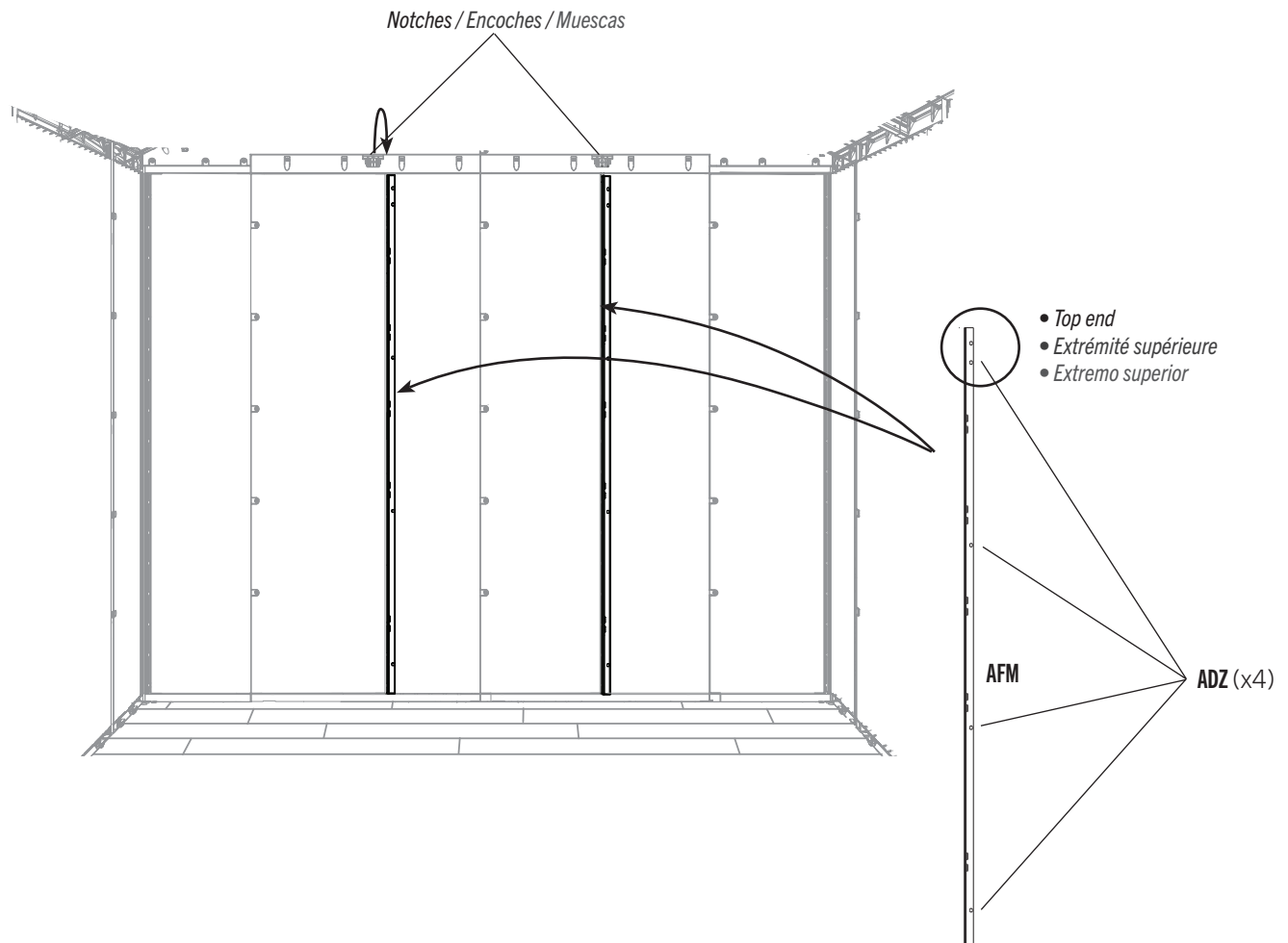

## ► SECTION 8 (CONTINUED) / SECTION 8 (SUITE) / SECCIÓN 8 (CONTINUACIÓN)

TOOLS AND HARDWARE REQUIRED / OUTILS ET QUINCAILLERIE REQUIS / INSTRUMENTAL Y HERRAJE REQUERIDOS

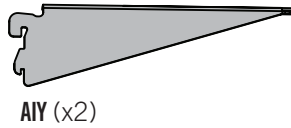

AIY (x2)

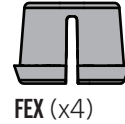

FEX (x4)

### 8.2

- Insert the **shelf brackets (AIY)** into the slots in the wall/shelf support channels. **The brackets must be at the same height.**
- Insérer les **équerres (AIY)** dans les fentes dans les canaux de support pour les murs/étagères. **Les équerres doivent être à la même hauteur.**
- Insertar las **escuadras (AIY)** en las ranuras en los canales de soporte para las paredes/estantes. **Las escuadras deben estar a la misma altura.**

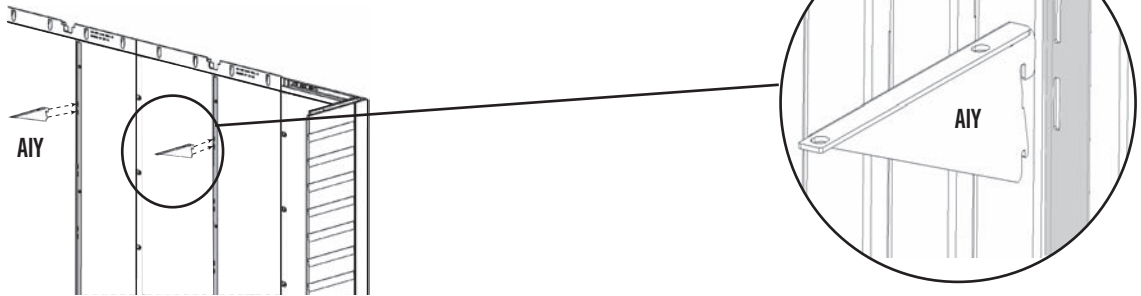

### 8.3

- Place **screw anchors (FEX)** into the side walls at the same level the shelf braces were placed.
- Placez les **vis d'ancrage (FEX)** dans les murs de côté à la même hauteur que vous avez placé les renforts de l'étagère.
- Coloque los **anclajes de tornillo (FEX)** en las paredes laterales al mismo nivel en el que se colocaron los soportes del estante.

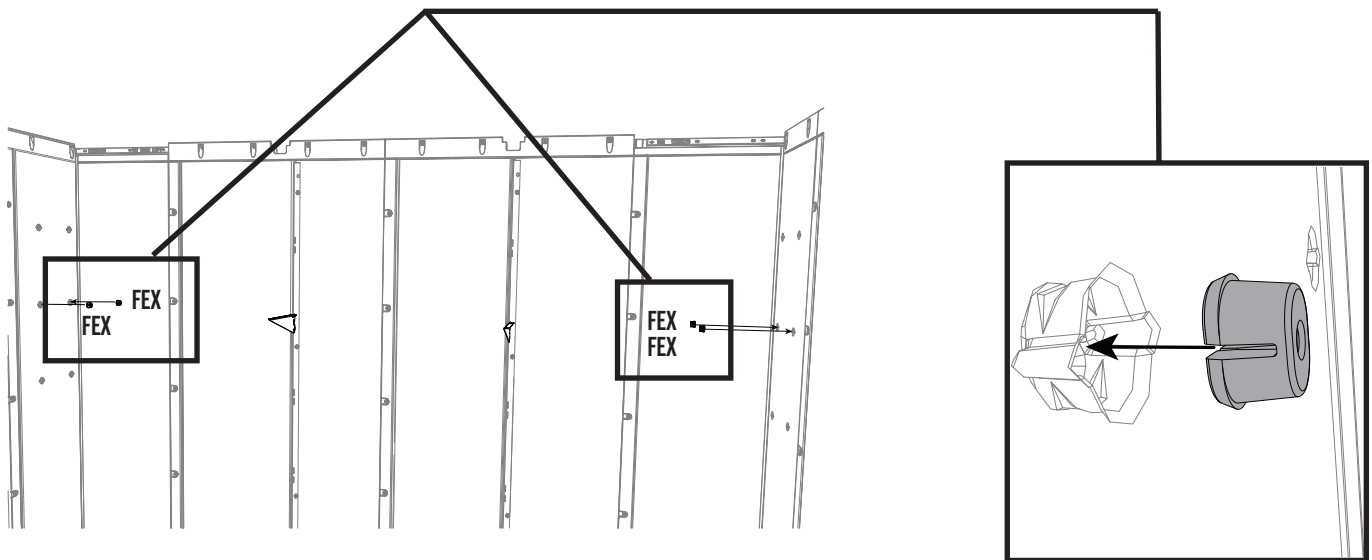



## ► SECTION 8 (CONTINUED) / SECTION 8 (SUITE) / SECCIÓN 8 (CONTINUACIÓN)

TOOLS AND HARDWARE REQUIRED / OUTILS ET QUINCAILLERIE REQUIS / INSTRUMENTAL Y HERRAJE REQUERIDOS

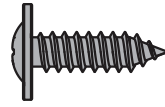

GJZ (x4)

### 8.4

- Attach a **shelf support bracket (HDV)** into the side wall at the same level the shelf braces were placed. Repeat for the other shelf support bracket on the opposite side.
- Placez le **support de l'étagère (HDV)** dans le mur de côté à la même hauteur que vous avez placé les renforts de l'étagère. Répétez pour le support de l'étagère de l'autre côté.
- Fije un **soporte de estante (HDV)** en la pared lateral al mismo nivel en el que se colocaron los soportes del estante. Repita para el otro soporte de estante en el lado opuesto.

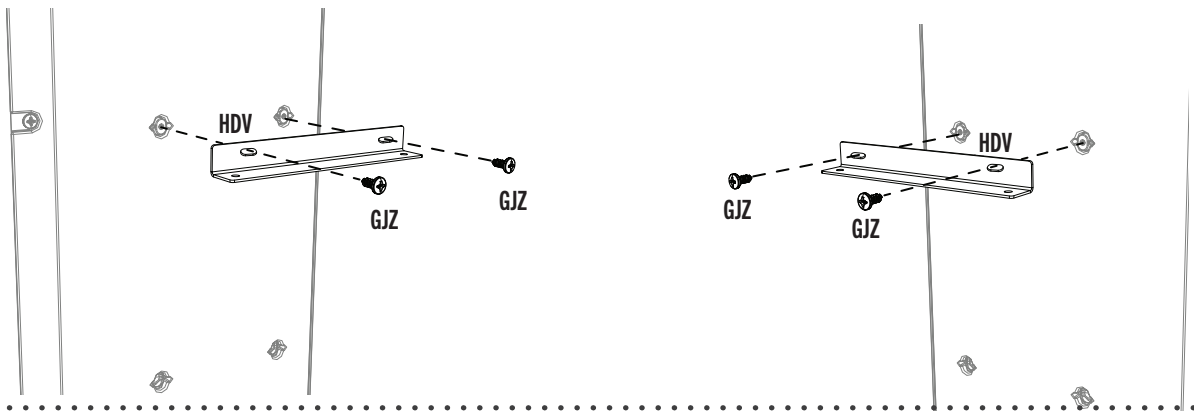

### 8.5

- *Unfold the shelf before installing.*
- *Dépliez l'étagère avant l'installation.*
- *Despliegue el estante antes de instalar.*

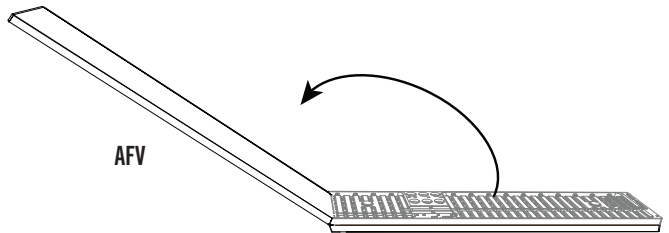

### 8.6

- Snap the **short and long shelf support tubes (HDT and HDU)** into the underside of the shelf. The long shelf support tube should be put in place near the side labelled "Front".
- Clipsez les **tubes d'appui long et court de l'étagère (HDT et HDU)** sous l'étagère. Le tube d'appui long doit être mis en place près du côté marqué « Devant ».
- Conecte a presión los **tubos de soporte del estante corto y largo (HDT y HDU)** en la parte inferior del estante. El tubo de soporte largo del estante debería ponerse en su lugar cerca del lado etiquetado "Front".

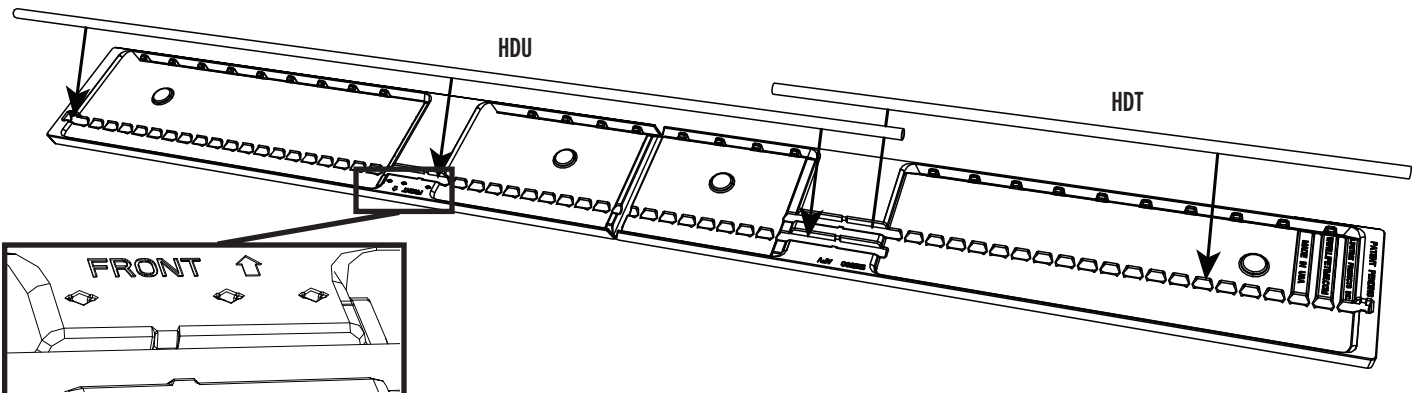

## ► SECTION 8 (CONTINUED) / SECTION 8 (SUITE) / SECCIÓN 8 (CONTINUACIÓN)

TOOLS AND HARDWARE REQUIRED / OUTILS ET QUINCAILLERIE REQUIS / INSTRUMENTAL Y HERRAJE REQUERIDOS

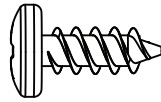

ADZ (x8)

### 8.7

- Attach the **shelf (AFV)** to the corner wall panels and shelf support brackets using eight (8) **screws (ADZ)**.
- Attachez l'**étagère (AFV)** aux panneaux de mur de coin et aux supports de l'étagère à l'aide de huit (8) **vis (ADZ)**.
- Fije el **estante (AFV)** a los paneles de pared de esquina y a los soportes del estante usando ocho (8) **tornillos (ADZ)**.

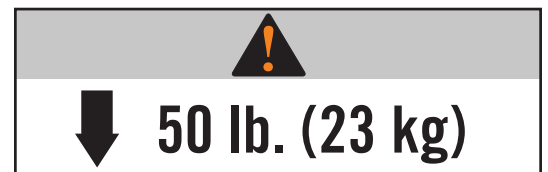
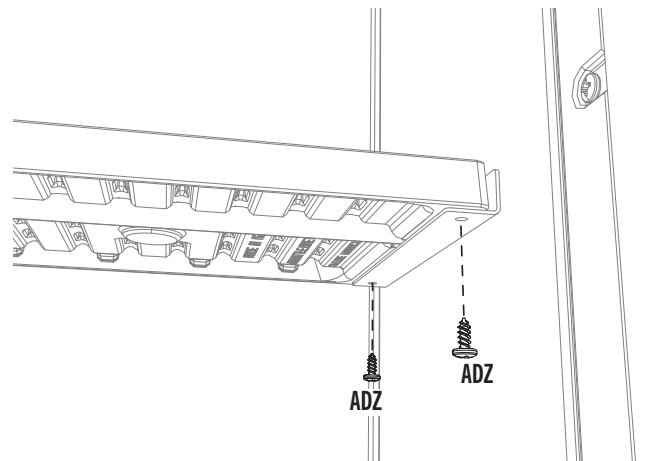
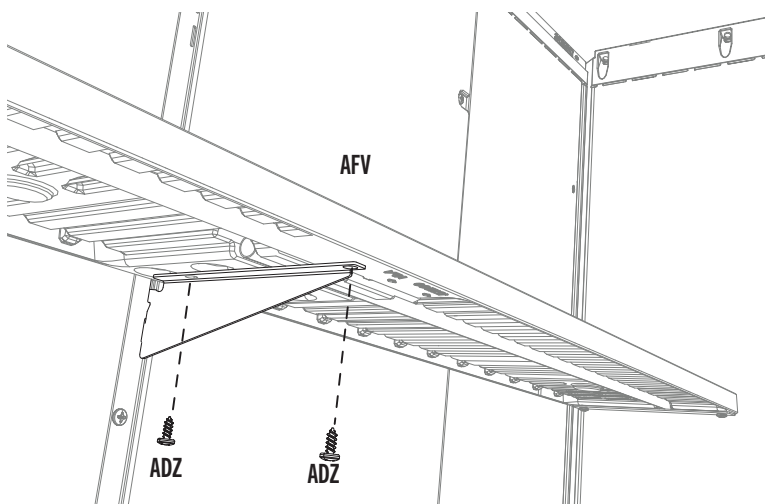
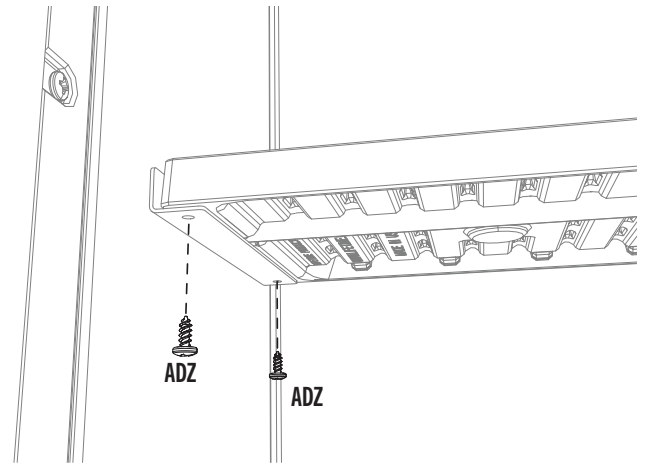
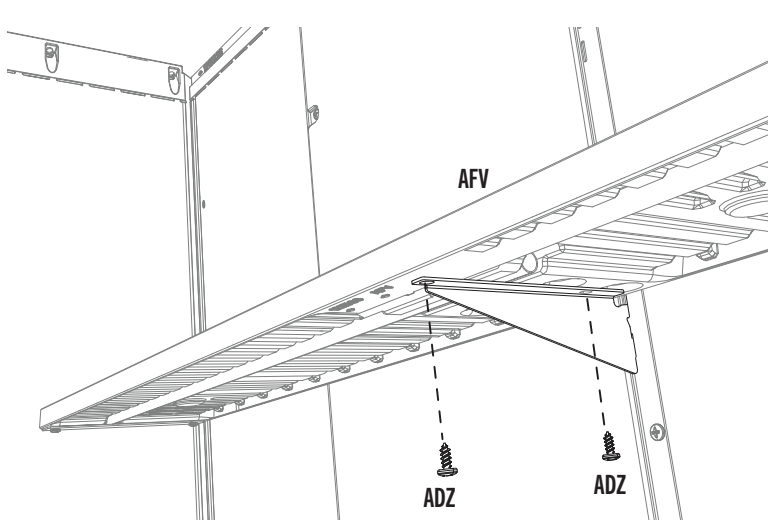

# 9

## DOOR & ENTRY GABLE INSTALLATION / INSTALLATION DU TOIT À PIGNON ET LES PORTES / INSTALACIÓN DE LA FACHADA DE ENTRADA Y LAS PUERTAS



### HARDWARE REQUIRED / QUINCAILLERIE REQUISE / HERRAJE REQUERIDO

Hardware Bag / Sac de quincaillerie / Bolsa de herraje

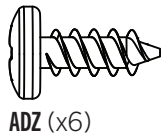

ADZ (x6)

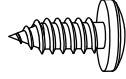

ADX (x4)



AHP (x2)

Parts / Pièces / Piezas

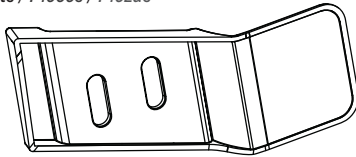

AIC (x1)

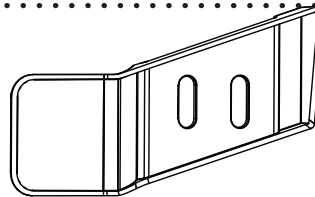

AIM (x1)



### PARTS REQUIRED / PIÈCES REQUISES / PIEZAS REQUERIDAS

Plastic Parts / Pièces en plastique / Piezas de plástico

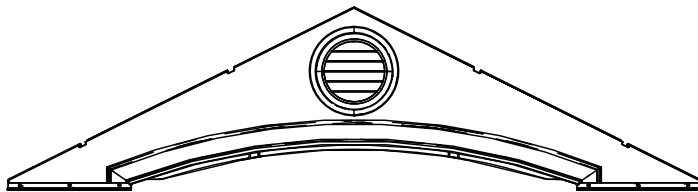

(x1)

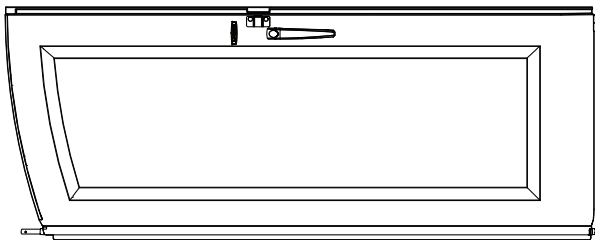

(x1)

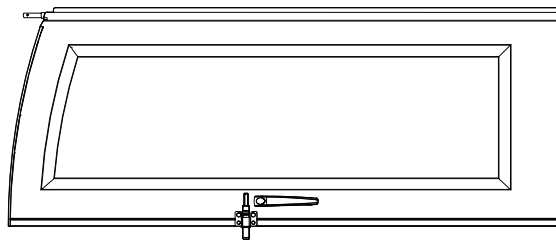

(x1)



TOOLS REQUIRED (NOT INCLUDED—UNLESS INDICATED OTHERWISE\*) / OUTILS REQUIS (NON INCLUS—SAUF INDICATION CONTRAIRE\*) / INSTRUMENTAL REQUERIDO (NO INCLUIDO, SALVO INDICACIÓN CONTRARIA\*)

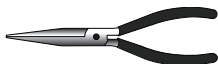

## ► SECTION 9 (CONTINUED) / SECTION 9 (SUITE) / SECCIÓN 9 (CONTINUACIÓN)

TOOLS AND HARDWARE REQUIRED / OUTILS ET QUINCAILLERIE REQUIS / INSTRUMENTAL Y HERRAJE REQUERIDOS



AHP (x2)

### 9.1



- Pull the hinge tube down out of the door about six inches. Align the hole at the bottom of the hinge tube with the slit in the bushing, and insert the tube. Insert a **cotter pin (AHP)** and bend the ends.
- Étendre le tube d'articulation à peu près quinze centimètres du bord inférieur de la porte. Aligner le trou dans la partie inférieure du tube avec la fente dans la bague, et insérer le tube. Insérer une **clavette (AHP)** et plier les extrémités.
- Extender el tubo de articulación unos quince centímetros del borde inferior de la puerta. Alinear el agujero en la parte inferior del tubo con la rendija en el casquillo, e insertar el tubo. Inserte una **clavija (AHP)** y doblar los extremos.

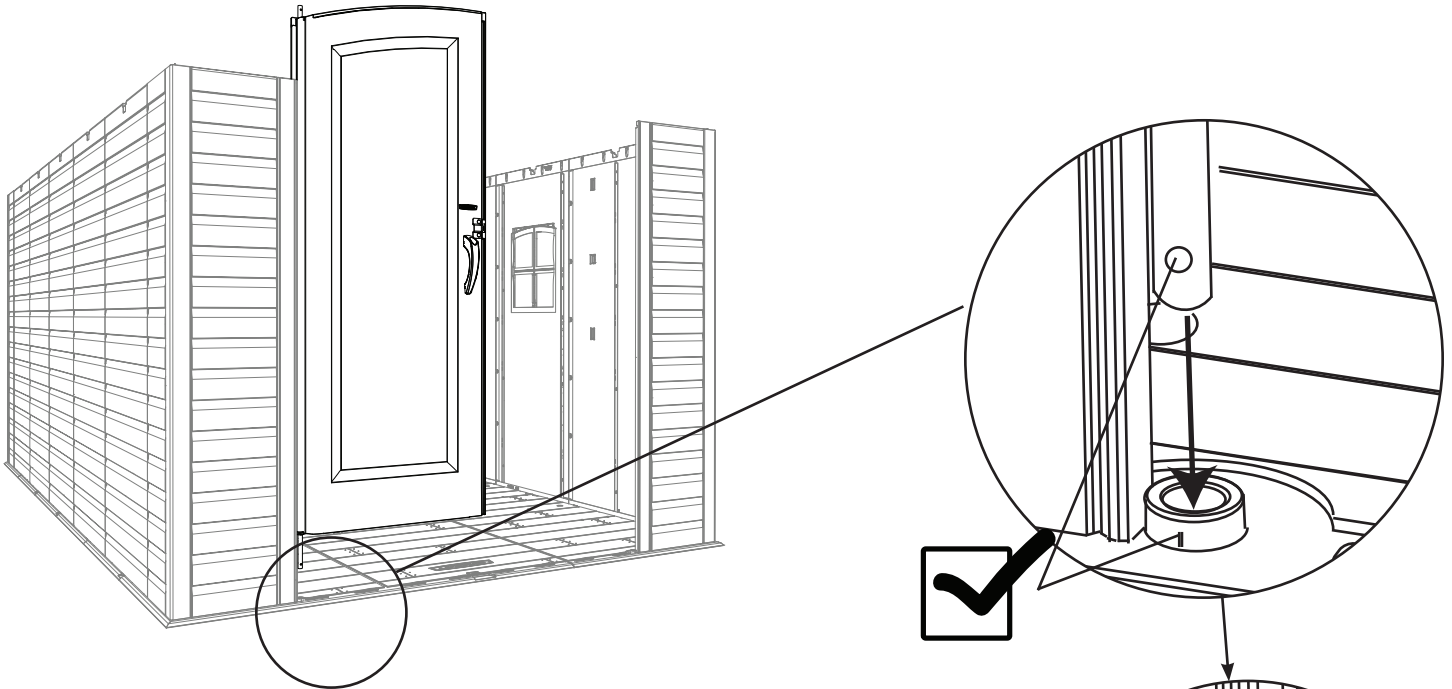

- Repeat this step for the right door.
- Répéter cette étape pour la porte droite.
- Repetir este paso para la puerta derecha.

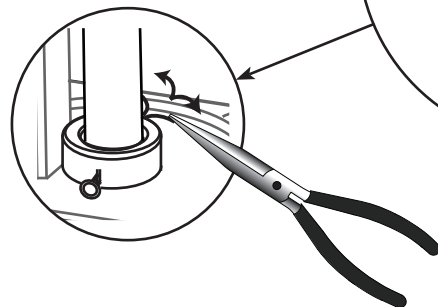
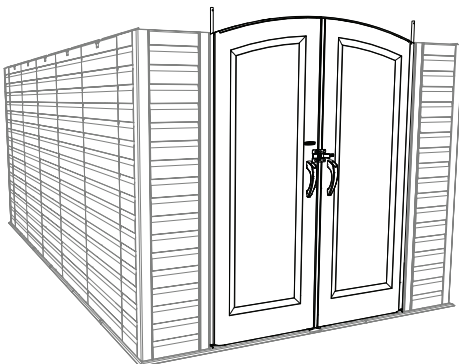

## ► SECTION 9 (CONTINUED) / SECTION 9 (SUITE) / SECCIÓN 9 (CONTINUACIÓN)

TOOLS AND HARDWARE REQUIRED / OUTILS ET QUINCAILLERIE REQUIS / INSTRUMENTAL Y HERRAJE REQUERIDOS

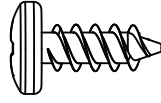

ADZ (x6)

### 9.2

- Slide the holes in the entry gable down over the two hinge tubes.
- Faire glisser les trous dans le toit à pignon d'entrée sur les deux tubes.
- Deslizar los agujeros en la fachada de entrada sobre los dos tubos.

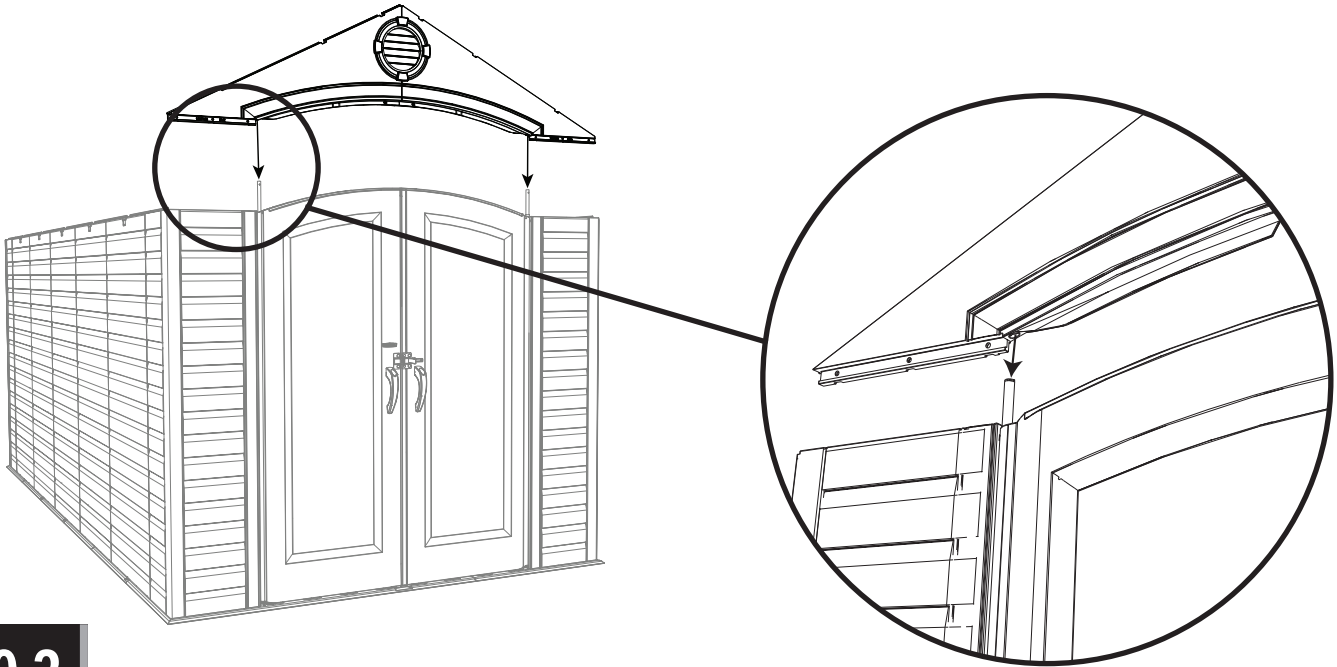

### 9.3

- Secure the entry gable to the shed using six (6) screws (ADZ).
- Attacher le toit à pignon d'entrée à l'abri à l'aide de six (6) vis (ADZ).
- Sujetar la fachada de entrada a la caseta usando seis (6) tornillos (ADZ).

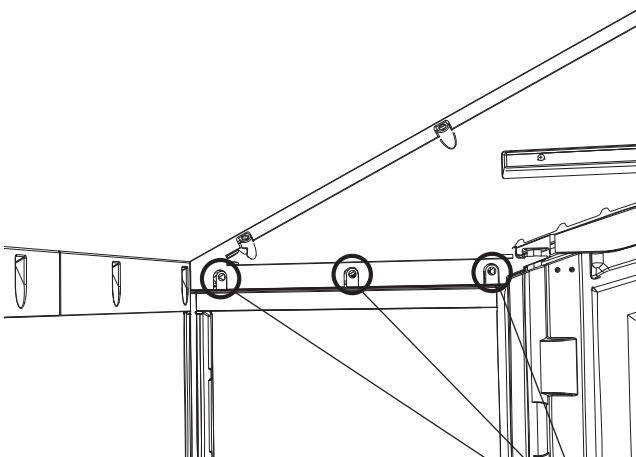

ADZ

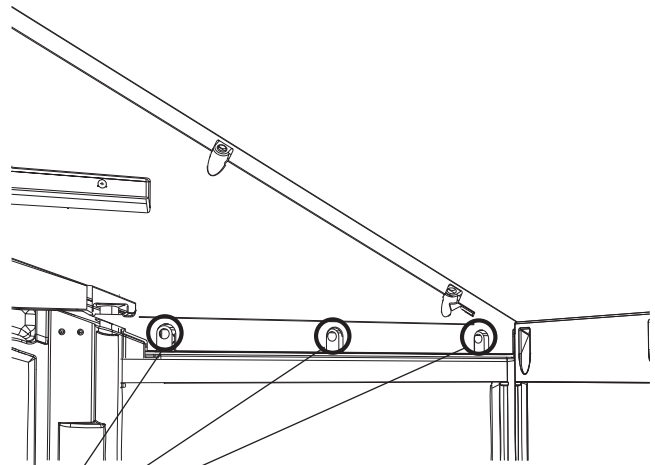

ADZ

## ► SECTION 9 (CONTINUED) / SECTION 9 (SUITE) / SECCIÓN 9 (CONTINUACIÓN)

TOOLS AND HARDWARE REQUIRED / OUTILS ET QUINCAILLERIE REQUIS / INSTRUMENTAL Y HERRAJE REQUERIDOS

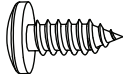

ADX (x4)

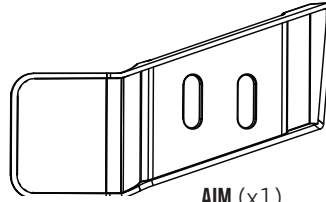

AIM (x1)

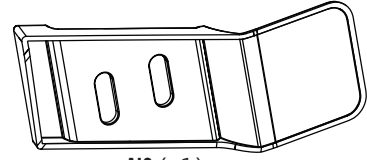

AIC (x1)

### 9.4

- Attach the **left (AIC)** and **right (AIM)** gap flaps to the corners of the doors using the hardware included. **These flaps simply serve to block out light.**
- Attacher les **rabats gauche (AIC)** et **droit (AIM)** aux portes à l'aide de la quincaillerie incluse. **Ces rabats ne servent que pour empêcher la lumière d'entrer.**
- Sujeter las **tapas de las puertas izquierda (AIC)** y **derecha (AIM)** a las puertas usando el herraje incluido. **Estas tapas sirven sólo para tapar la luz.**

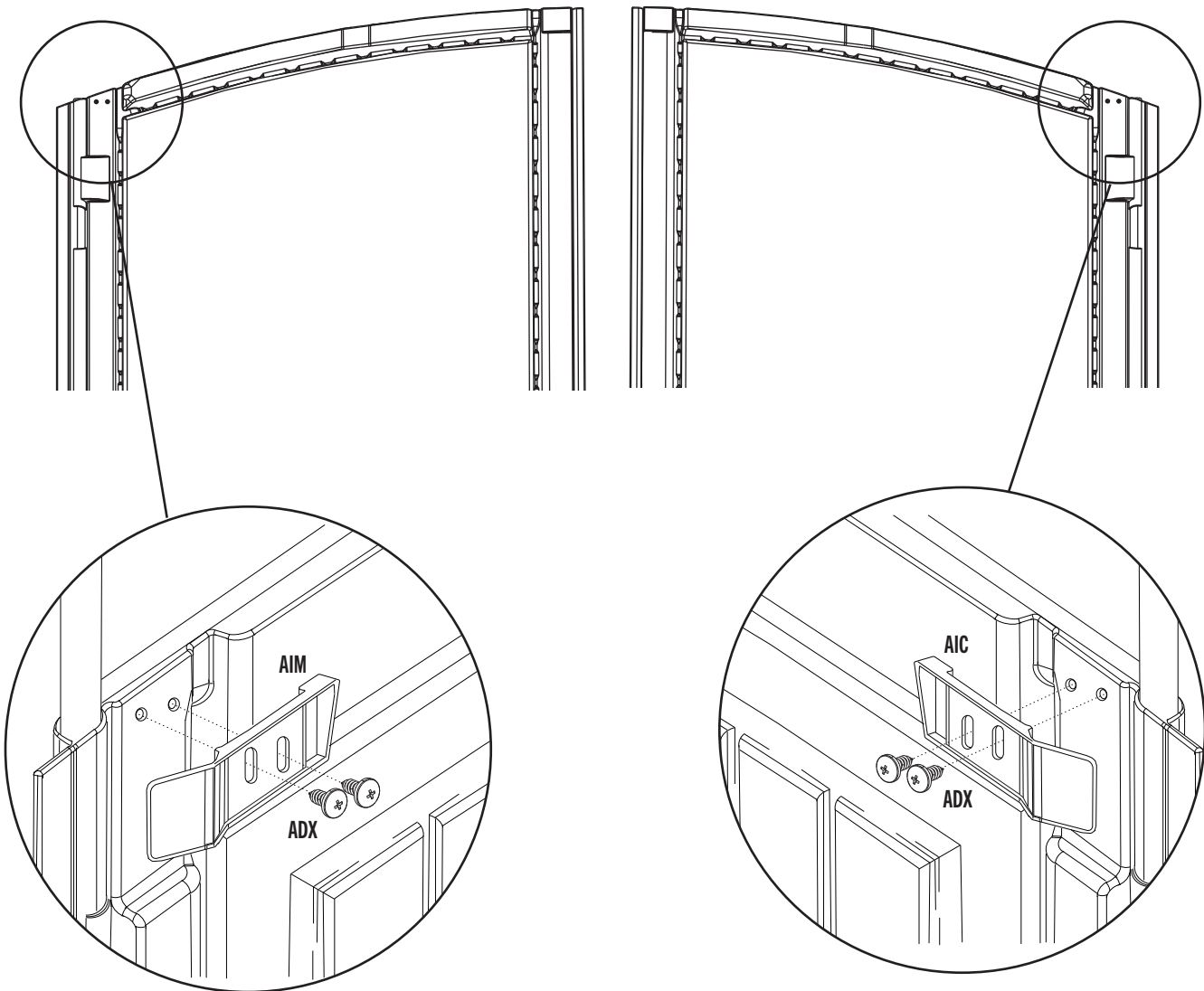

# 10

## ROOF ASSEMBLY / ASSEMBLAGE DU TOIT / ENSAMBLE DEL TEJADO



### HARDWARE REQUIRED / QUINCAILLERIE REQUISE / HERRAJE REQUERIDO

Hardware Bag / Sac de quincaillerie / Bolsa de herraje

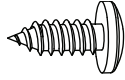

ADX (x36)

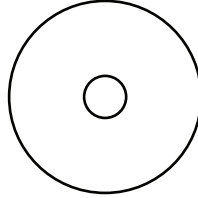

AED (x36)

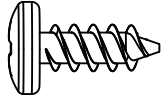

ADZ (x185)

Parts / Pièces / Piezas

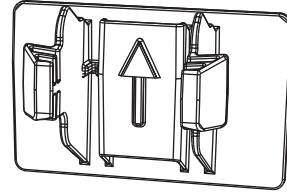

AXX (x2)



### PARTS REQUIRED / PIÈCES REQUISES / PIEZAS REQUERIDAS

Metal Parts / Pièces en métal / Piezas de metal



AFL (x12)

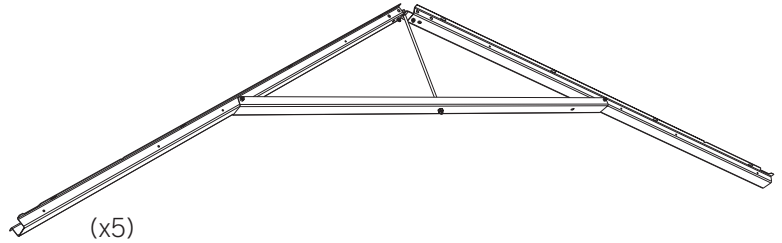

Plastic Parts / Pièces en plastique / Piezas de plástico

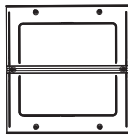

AHC (x6)

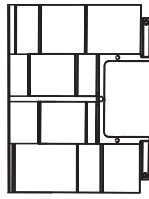

AGG (x1)

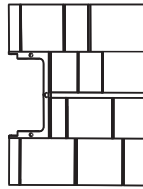

AFW (x1)

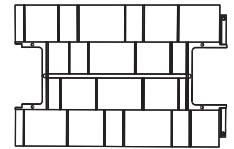

AFY (x5)

Plastic Parts / Pièces en plastique / Piezas de plástico

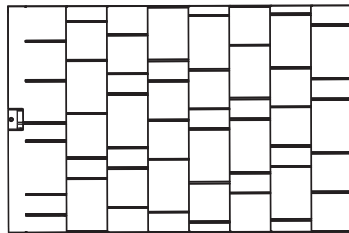

AGQ (x12)

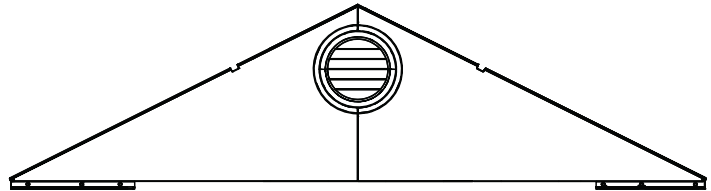

TOOLS REQUIRED (NOT INCLUDED—UNLESS INDICATED OTHERWISE\*) / OUTILS REQUIS (NON INCLUS—SAUF INDICATION CONTRAIRE\*) / INSTRUMENTAL REQUERIDO (NO INCLUIDO, SALVO INDICACIÓN CONTRARIA\*)



## ► SECTION 10 (CONTINUED) / SECTION 10 (SUITE) / SECCIÓN 10 (CONTINUACIÓN)

TOOLS AND HARDWARE REQUIRED / OUTILS ET QUINCAILLERIE REQUIS / INSTRUMENTAL Y HERRAJE REQUERIDOS



### 10.1

- Set a truss assembly into the notches on the first two opposite wall panels. Set a **roof panel (AGQ)** onto the gable, wall panel, and truss assembly.
- Colocar una cercha dentro de las muescas de los primeros dos paneles de pared opuestos. Colocar un **panel de tejado (AGQ)** sobre la fachada de entrada, panel mural, y la cercha.
- Mettez une ferme dans les encoches des premiers deux panneaux muraux opposés. Mettre un **panneaux de toit (AGQ)** sur le toit à pignon, panneau mural, et la ferme.

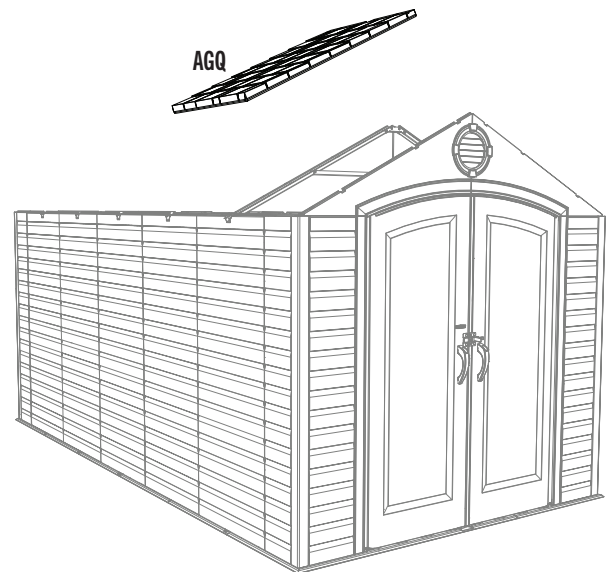
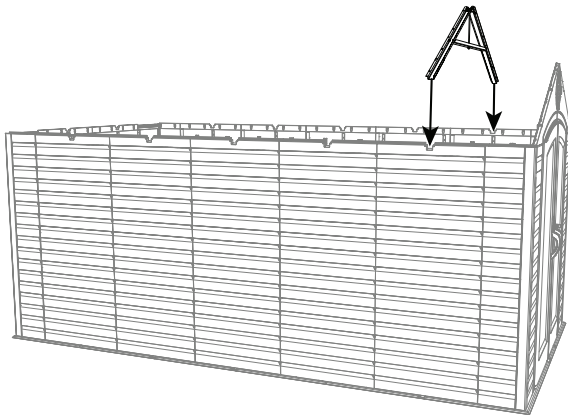

### 10.2

- The groove at the bottom of the roof panel sets over the top of the wall panel. Ensure the alignment nub fits into the notch in the truss.
- Mettre la rainure au bord inférieur du panneau de toit sur la partie supérieure du panneau mural. Mettre la petite bosse d'alignement dans l'encoche de la ferme.
- Colocar la ranura a lo largo del borde inferior del panel de tejado sobre la parte superior del panel de pared. Encajar el bulbo de alineamiento en la muesca en la cercha.

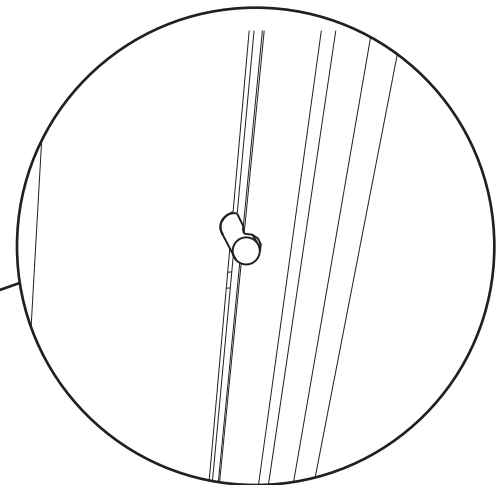
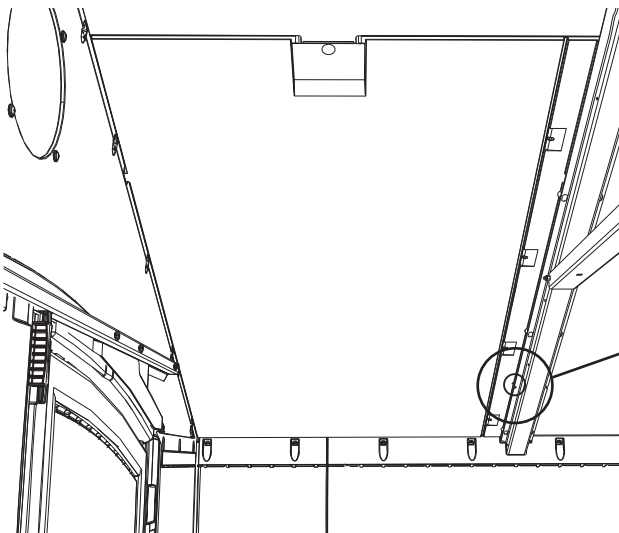



## ► SECTION 10 (CONTINUED) / SECTION 10 (SUITE) / SECCIÓN 10 (CONTINUACIÓN)

TOOLS AND HARDWARE REQUIRED / OUTILS ET QUINCAILLERIE REQUIS / INSTRUMENTAL Y HERRAJE REQUERIDOS

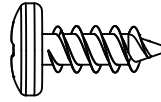

ADZ (x6)

### 10.3

- Align the four holes in the wall panel with those at the bottom of the roof panel, and insert four (4) **screws (ADZ)** to secure the panel in place.
- Aligner les quatre trous dans le panneau mural avec ceux au bord inférieur du panneau de toit, et insérer quatre (4) **vis (ADZ)** pour attacher le panneau en place.
- Alinear los cuatro agujeros en el panel de pared con los al borde inferior del panel de tejado, e insertar cuatro (4) **tornillos (ADZ)** para sujetarlo en su lugar.

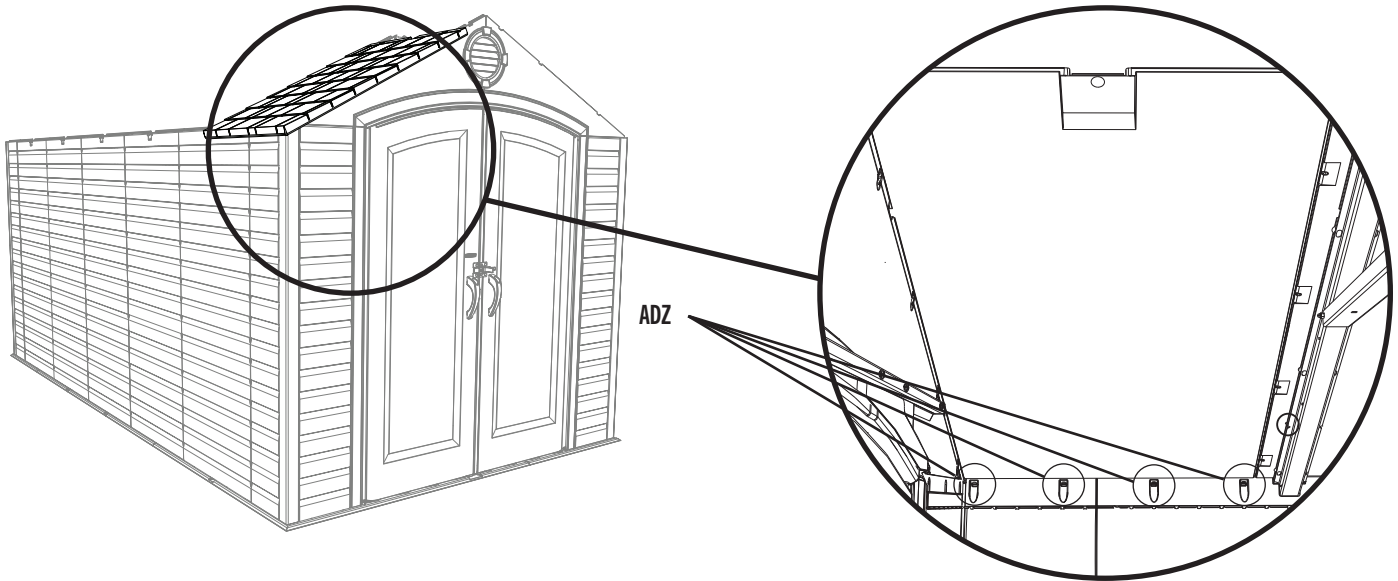

### 10.4

- Insert the first two **screws (ADZ)** through the gable and into the roof panel at the locations shown. Insert the **roof support (AFL)** into the notches in the gable and between the truss and the roof panel.
- Insérer les premières deux **vis (ADZ)** à travers le toit à pignon et dans le panneau de toit aux emplacements illustrés. Mettre le **support de toit (AFL)** dans les encoches dans le toit à pignon et entre le panneau de toit et la ferme.
- Insertar los primeros dos **tornillos (ADZ)** por el faldón y dentro del panel de tejado a las ubicaciones ilustrados. Inserte el **soporte de tejado (AFL)** en las muescas en el faldón y entre la cercha y el panel de tejado.

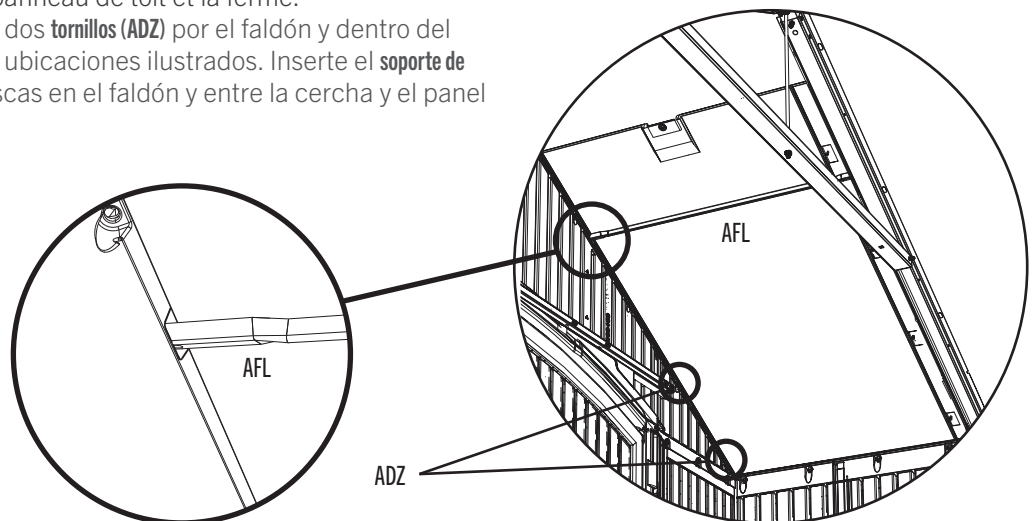

## ► SECTION 10 (CONTINUED) / SECTION 10 (SUITE) / SECCIÓN 10 (CONTINUACIÓN)

TOOLS AND HARDWARE REQUIRED / OUTILS ET QUINCAILLERIE REQUIS / INSTRUMENTAL Y HERRAJE REQUERIDOS

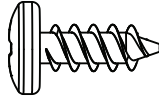

ADZ (x16)

### 10.5

- Insert five (5) more screws (ADZ) to secure the panel in place.
- Insérer cinq (5) autres vis (ADZ) pour attacher le panneau en place.
- Insertar cinco (5) tornillos (ADZ) más para sujetar el panel en su lugar.

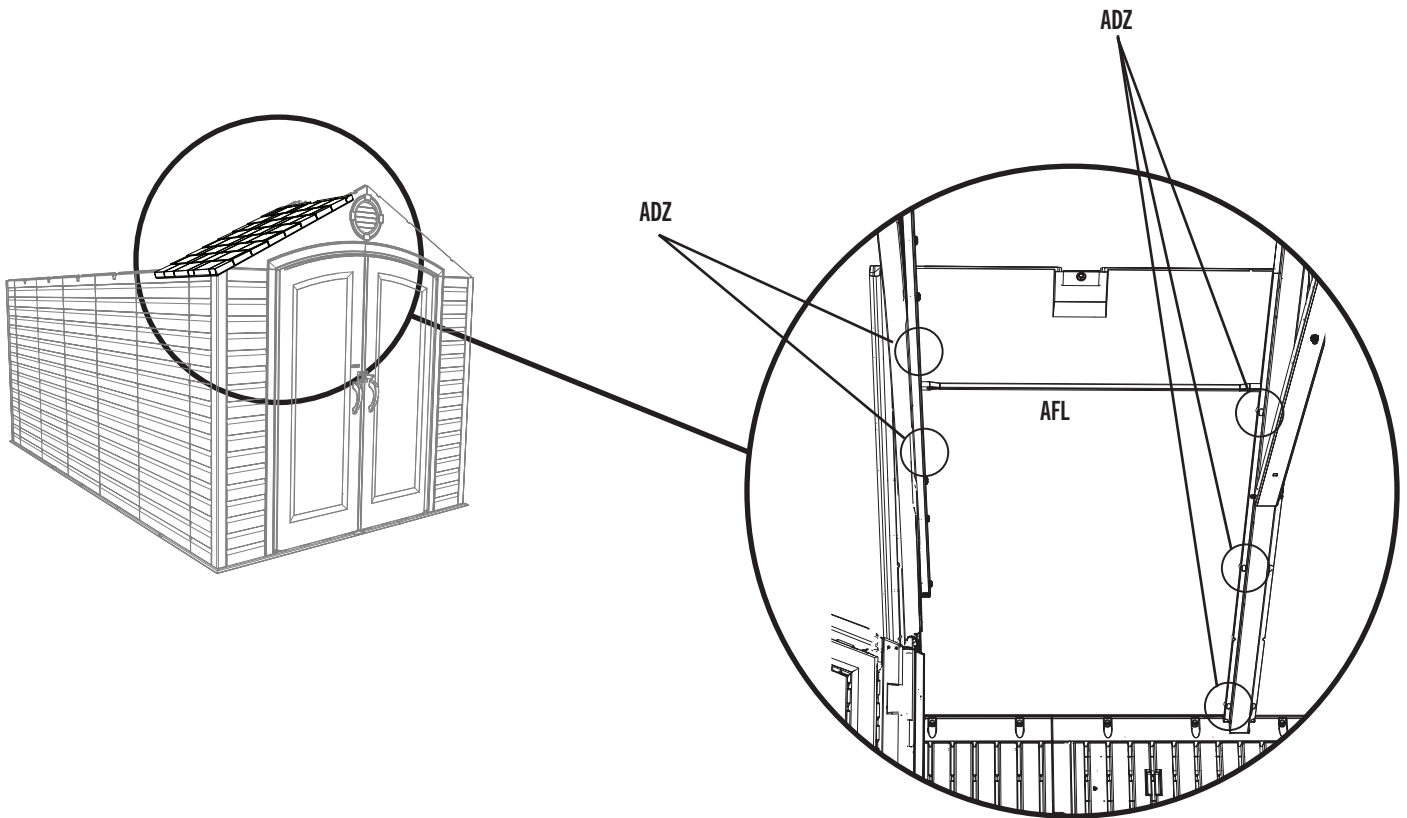

- Repeat steps 10.2 - 10.5 for the second front roof panel.
- Répéter les étapes 10.2 - 10.5 pour le deuxième panneau de toit avant.
- Repetir los pasos 10.2 - 10.5 para el segundo panel de tejado delantero.

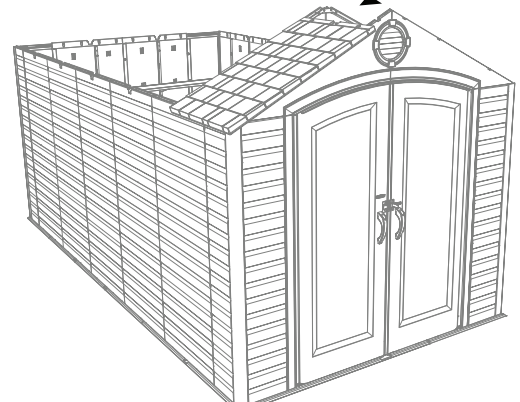
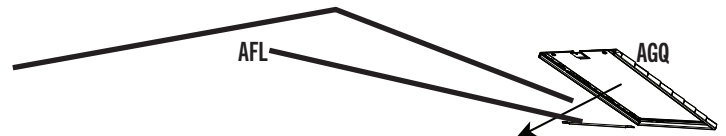

## ► SECTION 10 (CONTINUED) / SECTION 10 (SUITE) / SECCIÓN 10 (CONTINUACIÓN)

TOOLS AND HARDWARE REQUIRED / OUTILS ET QUINCAILLERIE REQUIS / INSTRUMENTAL Y HERRAJE REQUERIDOS

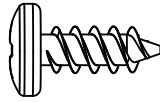

ADZ (x40)

### 10.6

- Attach the next four roof panels in a similar way as the first two.
- Attacher les quatre panneaux de toit suivants d'une façon similaire que les premiers panneaux.
- Sujetar los siguientes cuatro paneles de tejado de una manera similar que los primeros dos.

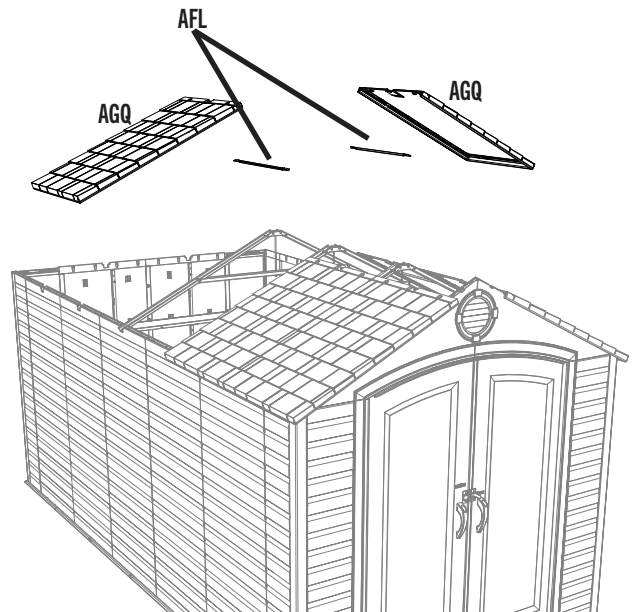
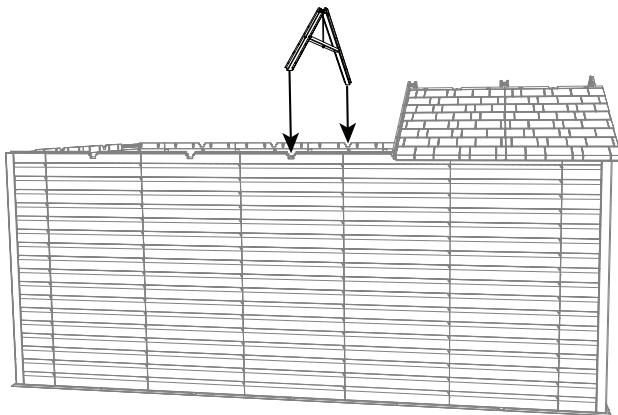
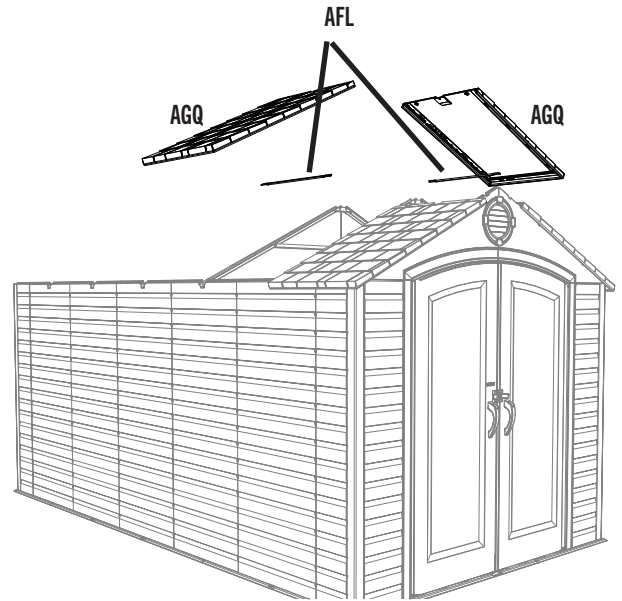
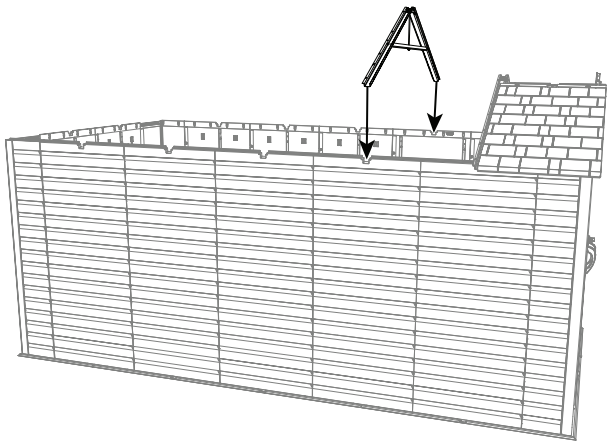

► SECTION 10 (CONTINUED) / SECTION 10 (SUITE) / SECCIÓN 10 (CONTINUACIÓN)

TOOLS AND HARDWARE REQUIRED / OUTILS ET QUINCAILLERIE REQUIS / INSTRUMENTAL Y HERRAJE REQUERIDOS

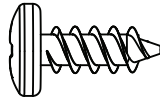

ADZ (x40)

10.7

- Attach the next four roof panels in a similar way as the first two.
- Attacher les quatre panneaux de toit suivants d'une façon similaire que les premiers panneaux.
- Sujetar los siguientes cuatro paneles de tejado de una manera similar que los primeros dos.

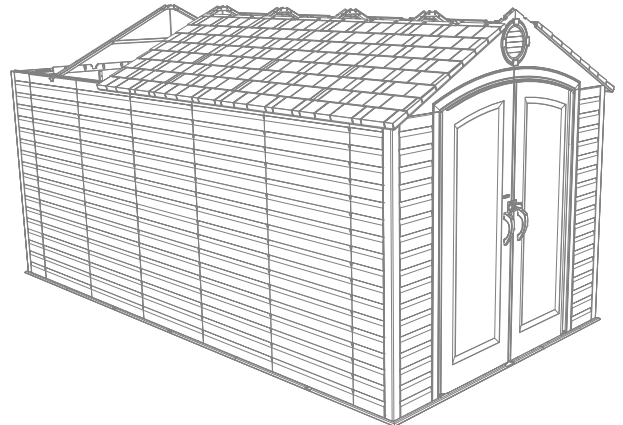
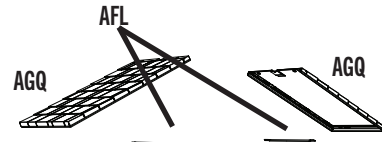
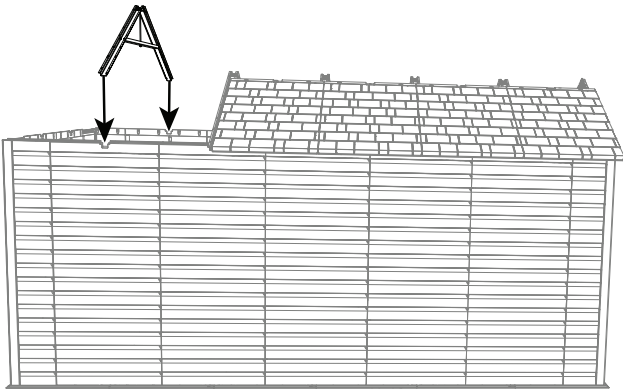
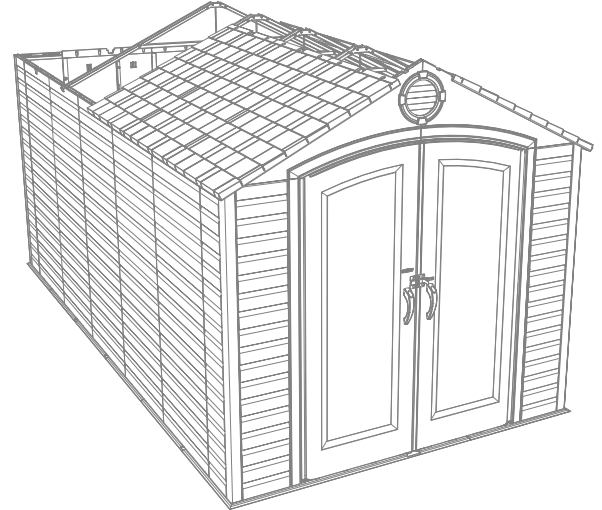
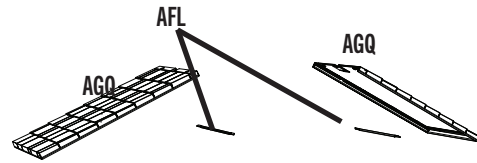
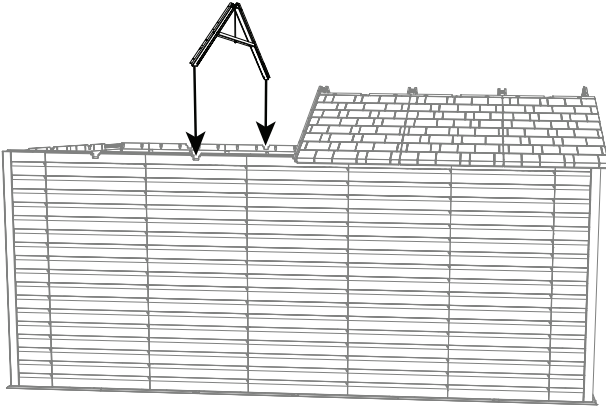

## ► SECTION 10 (CONTINUED) / SECTION 10 (SUITE) / SECCIÓN 10 (CONTINUACIÓN)

TOOLS AND HARDWARE REQUIRED / OUTILS ET QUINCAILLERIE REQUIS / INSTRUMENTAL Y HERRAJE REQUERIDOS

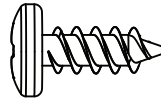

ADZ (x14)

### 10.8

- Attach the rear gable to the shed using fourteen (14) screws (ADZ).
- Attacher le toit à pignon arrière à l'abri à l'aide de quatorze (14) vis (ADZ).
- Sujetar la fachada trasera a la caseta usando catorce (14) tornillos (ADZ).

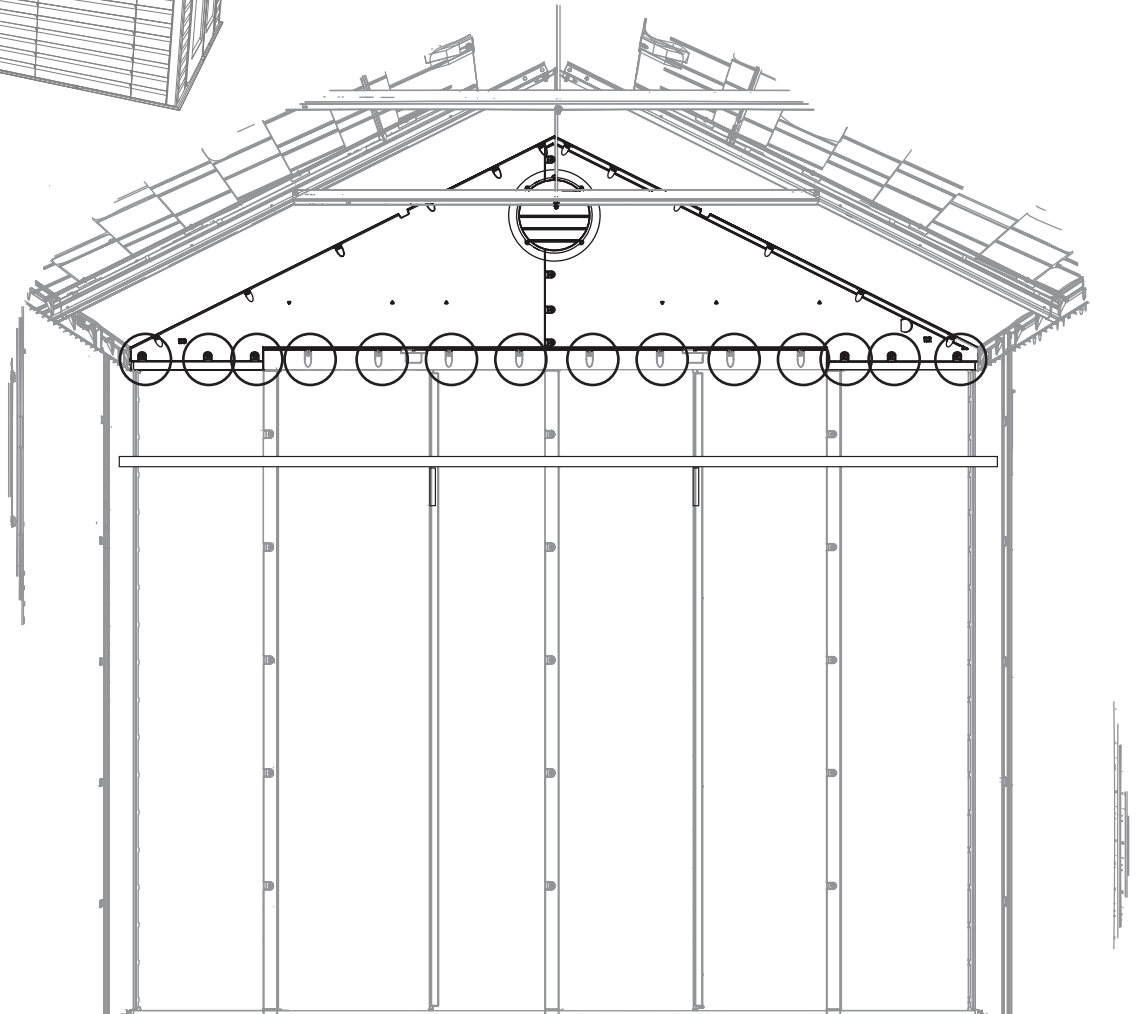
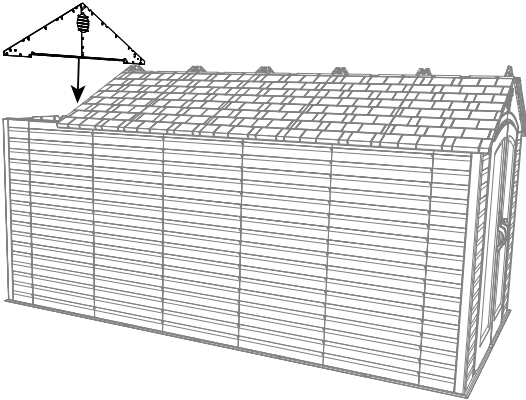

## ► SECTION 10 (CONTINUED) / SECTION 10 (SUITE) / SECCIÓN 10 (CONTINUACIÓN)

TOOLS AND HARDWARE REQUIRED / OUTILS ET QUINCAILLERIE REQUIS / INSTRUMENTAL Y HERRAJE REQUERIDOS

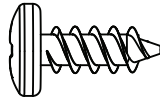

ADZ (x22)

### 10.9

- Attach the last two roof panels to the shed in the same way you did the first two.
- Attacher les derniers deux panneaux de toit à l'abri de la même façon que les premiers deux.
- Sujetar los últimos dos paneles de tejado a la caseta de la misma manera que los primeros dos.

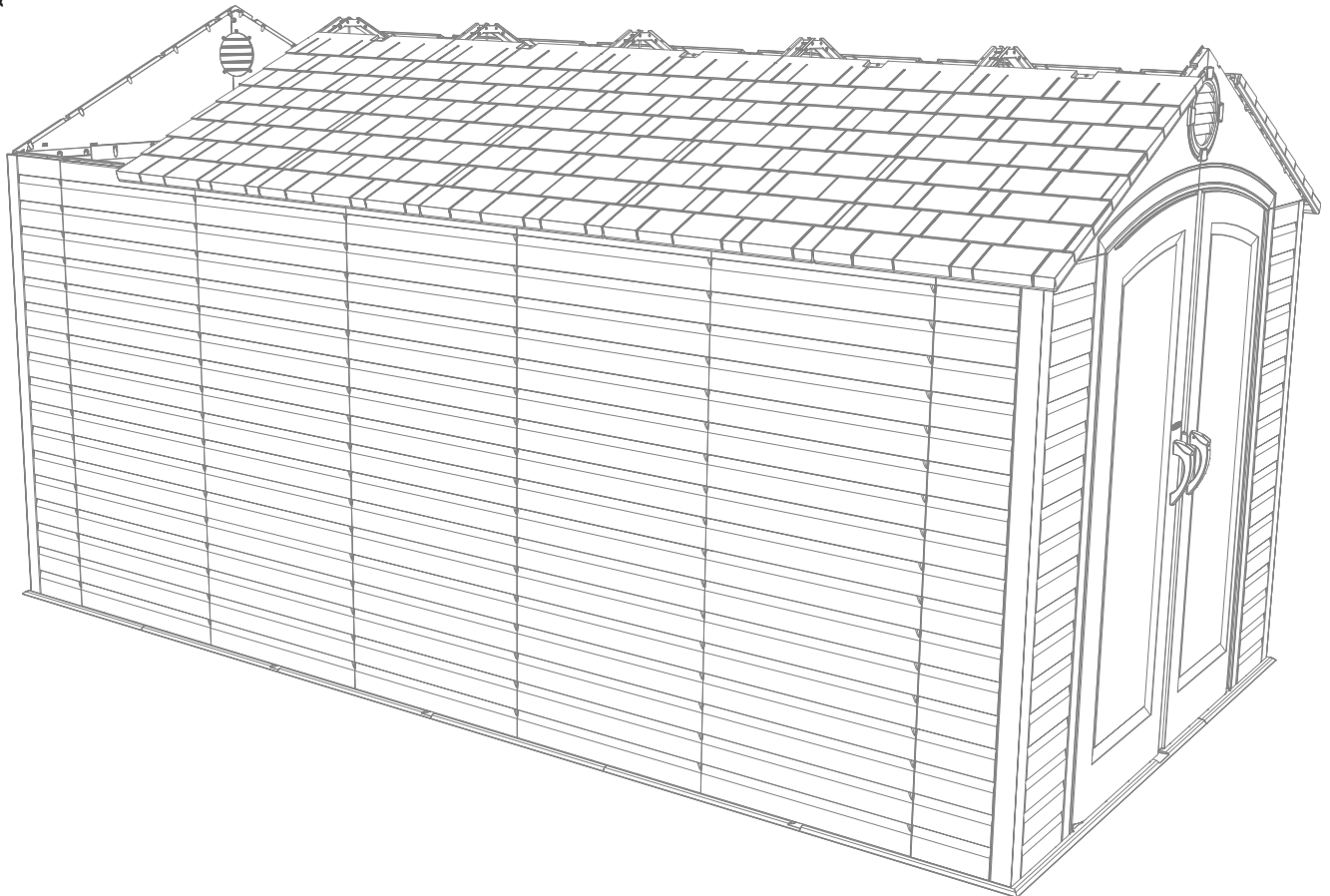
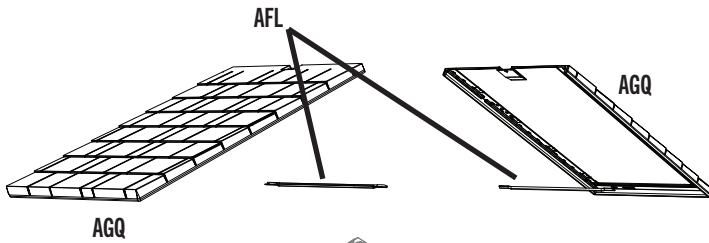

## ► SECTION 10 (CONTINUED) / SECTION 10 (SUITE) / SECCIÓN 10 (CONTINUACIÓN)

TOOLS AND HARDWARE REQUIRED / OUTILS ET QUINCAILLERIE REQUIS / INSTRUMENTAL Y HERRAJE REQUERIDOS

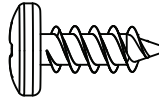

ADZ (x42)

### 10.10



- Starting at the front, attach the roof caps to the shed using the hardware included.
- En commençant à la partie avant, attacher les chapeaux à l'abri à l'aide de la quincaillerie incluse.
- Empezando a la parte delantera, sujetar las cumbreras a la caseta usando el herraje incluido.



- The ends of the roof caps overlap one another.
- Les extrémités des chapeaux se chevauchent.
- Los extremos de las cumbreras se solapan.

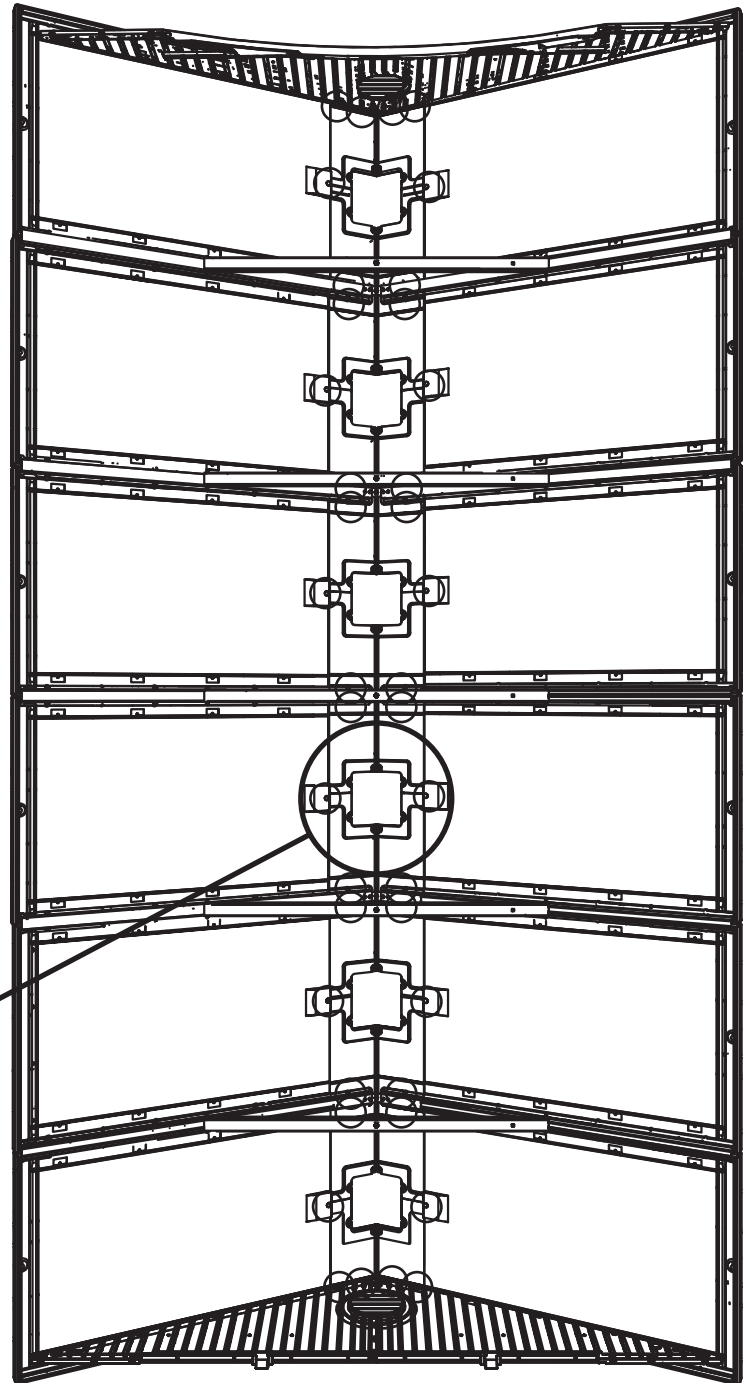
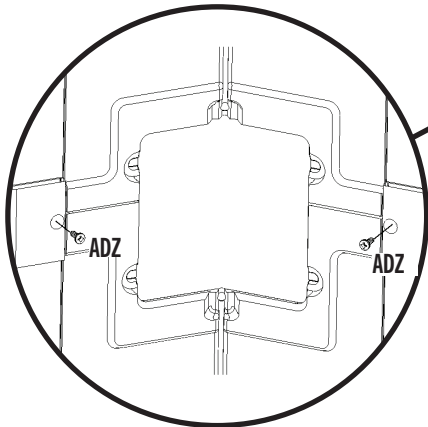
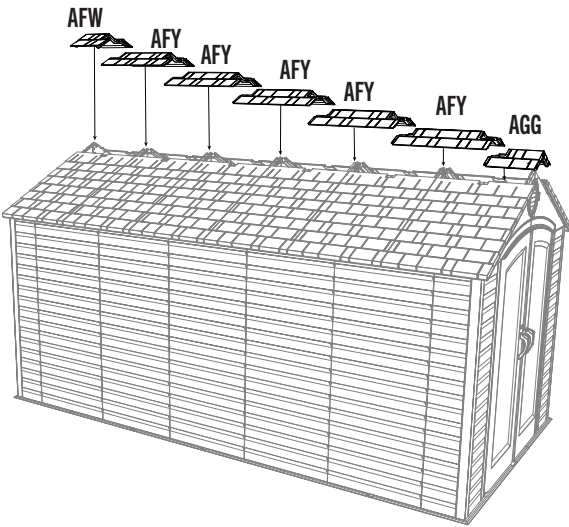

## ► SECTION 10 (CONTINUED) / SECTION 10 (SUITE) / SECCIÓN 10 (CONTINUACIÓN)

TOOLS AND HARDWARE REQUIRED / OUTILS ET QUINCAILLERIE REQUIS / INSTRUMENTAL Y HERRAJE REQUERIDOS

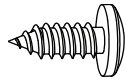

ADX (x36)

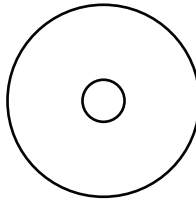

AED (x36)

### 10.11



- Fold a **skylight (AHC)**, and attach it to the roof using six (6) **screws (ADX)** and **washers (AED)** for each skylight.
- Doblar un **tragaluz (AHC)**, y sujételo al tejado usando seis (6) **tornillos (ADX)** y **rondanas (AED)** para cada tragaluz.
- Plier une **lucarne (AHC)**, et l'attacher au toit à l'aide de six (6) **vis (ADX)** et **rondelles (AED)** pour chaque lucarne.



- Repeat this step for the five remaining skylights.
- Répéter cette étape pour les cinq lucarnes restantes.
- Repetir este paso para los cinco tragaluces restantes.

AHC AHC AHC AHC AHC AHC

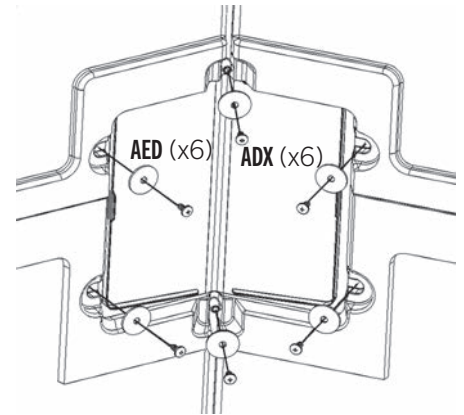
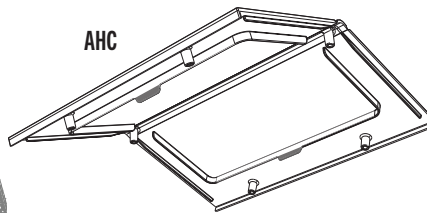
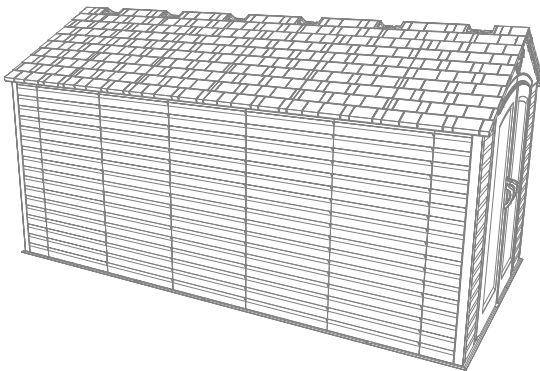

### 10.12

- Insert the **clips (AXX)** with the "arrow" facing up.
- Insérer les **clips (AXX)** avec la « flèche » vers le haut.
- Insertar los **clips (AXX)** con la « flecha » hacia arriba.

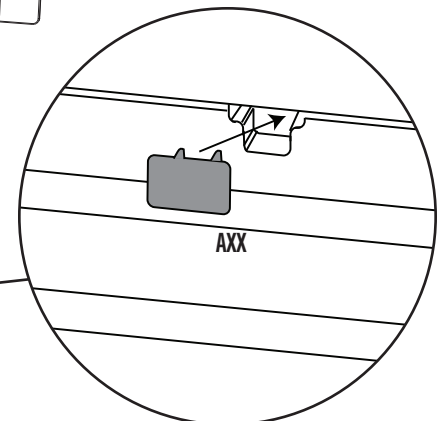
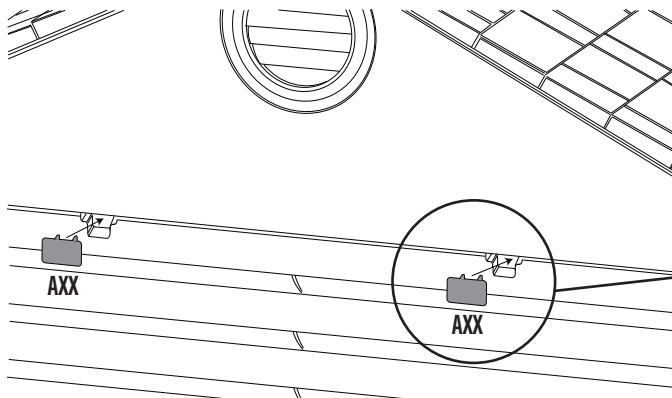
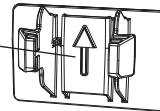





### HARDWARE REQUIRED / QUINCAILLERIE REQUISE / HERRAJE REQUERIDO

Hardware Bag / Sac de quincaillerie / Bolsa de herraje

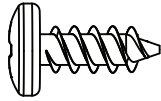

ADZ (x4)

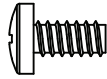

ADY (x1)

Parts / Pièces / Piezas

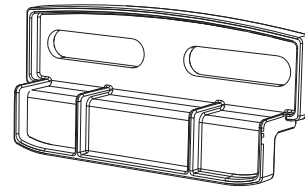

AIS (x2)



### PARTS REQUIRED / PIÈCES REQUISES / PIEZAS REQUERIDAS

Plastic Parts / Pièces en plastique / Piezas de plástico

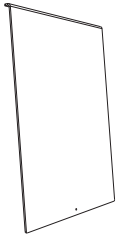

AHE (x1)



TOOLS REQUIRED (NOT INCLUDED—UNLESS INDICATED OTHERWISE\*) / OUTILS REQUIS (NON INCLUS—SAUF INDICATION CONTRAIRE\*) / INSTRUMENTAL REQUERIDO (NO INCLUIDO, SALVO INDICACIÓN CONTRARIA\*)



## ► SECTION 11 (CONTINUED) / SECTION 11 (SUITE) / SECCIÓN 11 (CONTINUACIÓN)

TOOLS AND HARDWARE REQUIRED / OUTILS ET QUINCAILLERIE REQUIS / INSTRUMENTAL Y HERRAJE REQUERIDOS

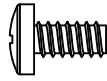

ADY (x1)

### 11.1

- Peel off the protective backing from both sides of the **window pane (AHE)**.
- Retirar el protector de plástico de las dos caras de la **hoja de ventana (AHE)**.
- Retirer la pellicule protectrice des deux côtés du **carreau (AHE)**.

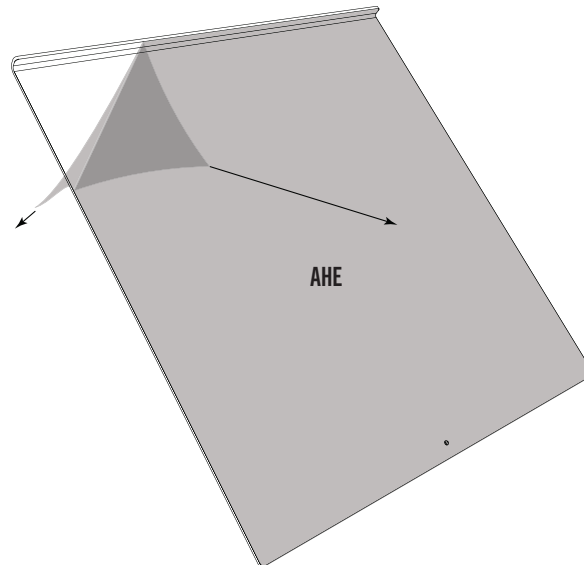

### 11.2

- With the curved edge at the top and facing toward you, slide the window pane down into the opening.
- Con el borde curvado hacia arriba y el interior, deslizar la hoja de ventana en su lugar.
- Avec le bord courbé vers le haut et faisant face de vous, faire glisser le carreau en place.

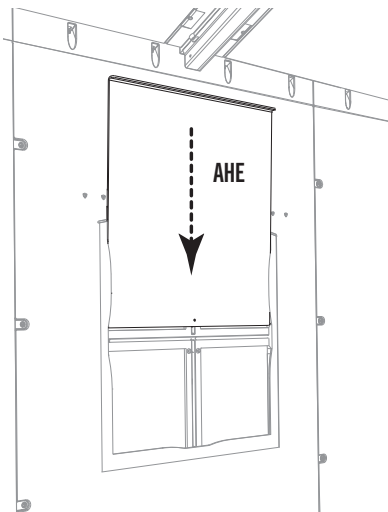

### 11.3

- Insert a **screw (ADY)** into the hole at the bottom of the window pane. **This helps keep the window up when open.**
- Introducir un **tornillo (ADY)** en el agujero al borde inferior de la hoja. **Esto ayuda a prevenir la cierre de la hoja de ventana.**
- Insérer une **Vis (ADY)** dans le trou au bord inférieur du carreau. **Cela aide à maintenir le carreau vers le haut lorsqu'il est ouvert.**

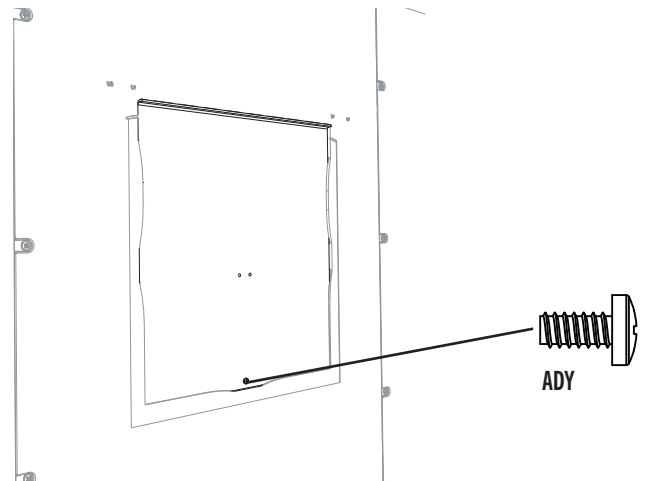

## ► SECTION 11 (CONTINUED) / SECTION 11 (SUITE) / SECCIÓN 11 (CONTINUACIÓN)

TOOLS AND HARDWARE REQUIRED / OUTILS ET QUINCAILLERIE REQUIS / INSTRUMENTAL Y HERRAJE REQUERIDOS

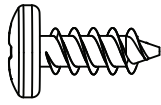

ADZ (x4)

### 11.4

- Attach the two (2) **window latches (ADY)** at the top corners of the panel opening.
- Attacher les deux (2) **loquets (ADY)** aux angles supérieurs de l'ouverture du panneau.
- Sujetar los dos (2) **cerrojos (ADY)** a las esquinas superiores de la abertura del panel.

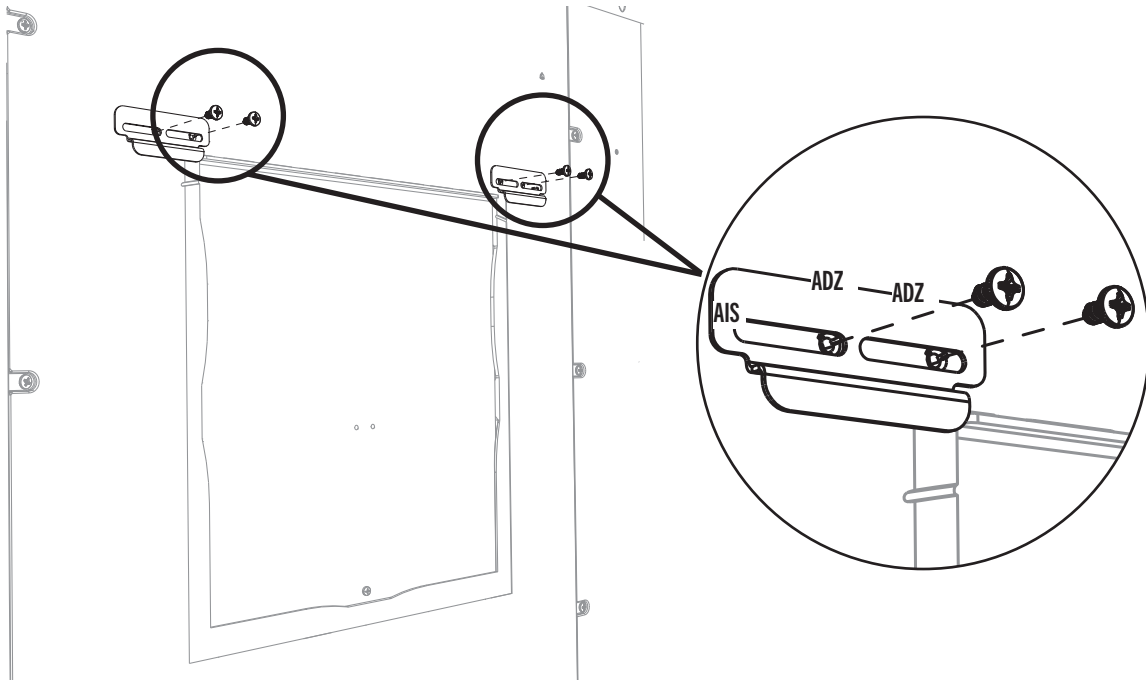

- *The latch should move freely.*
- *Le loquet doit se déplacer librement.*
- *El cerrojo debe mover libremente*

# 12

## DOOR ALIGNMENT / ALIGNEMENT DES PORTES / ALINEACIÓN DE LAS PUERTAS



### HARDWARE REQUIRED / QUINCAILLERIE REQUISE / HERRAJE REQUERIDO



### PARTS REQUIRED / PIÈCES REQUISES / PIEZAS REQUERIDAS

*Plastic Parts / Pièces en plastique / Piezas de plástico*

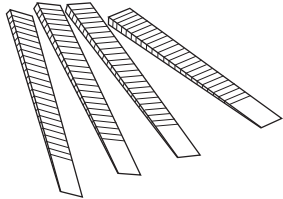

**AIX** (x4)



### TOOLS REQUIRED (NOT INCLUDED—UNLESS INDICATED OTHERWISE\*) / OUTILS REQUIS (NON INCLUS—SAUF INDICATION CONTRAIRE\*) / INSTRUMENTAL REQUERIDO (NO INCLUIDO, SALVO INDICACIÓN CONTRARIA\*)

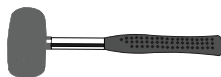
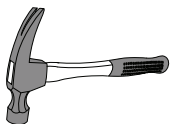

## ► SECTION 12 (CONTINUED) / SECTION 12 (SUITE) / SECCIÓN 12 (CONTINUACIÓN)

TOOLS AND HARDWARE REQUIRED / OUTILS ET QUINCAILLERIE REQUIS / INSTRUMENTAL Y HERRAJE REQUERIDOS

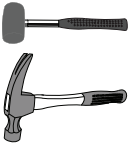

### 12.1

- If the doors are not level, follow the steps on this page or the next to even them out.
- Si les portes ne sont pas niveau l'une avec l'autre, suivre les étapes dans cette page ou la suivante pour les niveler.
- Si las puertas no están niveladas, seguir los pasos en esta página o la siguiente para nivelarlas.

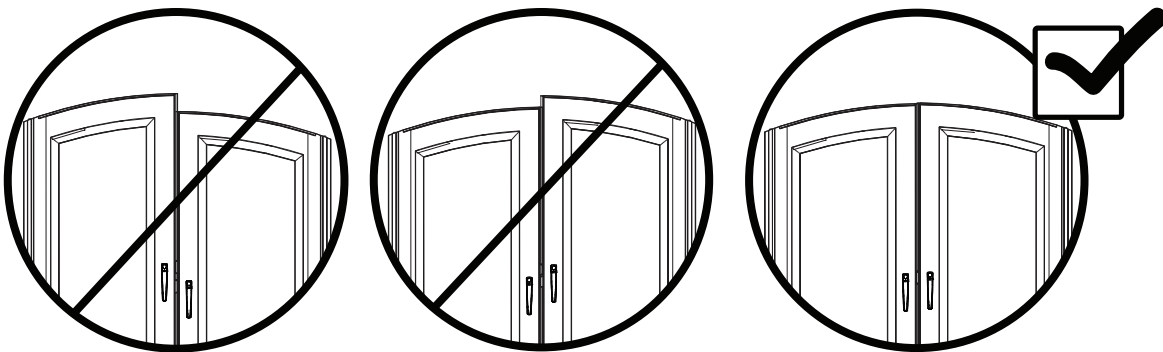

### 12.2

- If the left door is higher, insert a **shim (AIX)** underneath the right, front and left, rear corners of the shed until the doors are the same height. **Break off any excess shim.**
- Si la porte gauche est plus haute, insérer une **cale (AIX)** sous le coin avant droit jusqu'à ce que les portes restent à la même hauteur. **Détacher de l'excès des cales.**
- Si la puerta izquierda es más alta, insertar una **cuña (AIX)** debajo las esquinas delantera derecha y trasera izquierda hasta que las puertas queden a la misma altura. **Quebrantar cualquier exceso de las cuñas.**

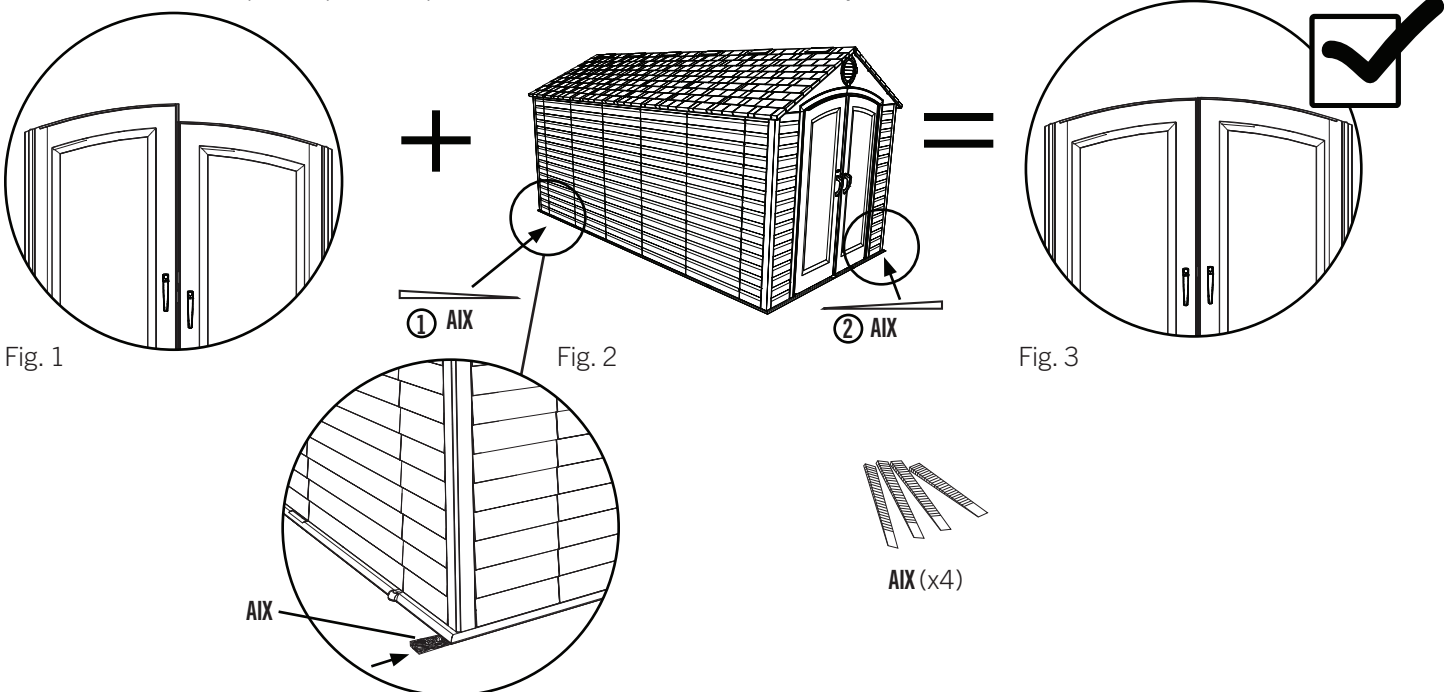

## ► SECTION 12 (CONTINUED) / SECTION 12 (SUITE) / SECCIÓN 12 (CONTINUACIÓN)

TOOLS AND HARDWARE REQUIRED / OUTILS ET QUINCAILLERIE REQUIS / INSTRUMENTAL Y HERRAJE REQUERIDOS

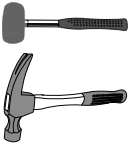

### 12.3

- If the right door is higher, insert a **shim (AIX)** underneath the left, front and right, rear corners of the shed until the doors are the same height. **Break off any excess shim.**
- Si la porte droite est plus haute, insérer une **cale (AIX)** sous les coins avant gauche et arrière droit jusqu'à ce que les portes restent à la même hauteur. **Détacher de l'excès des cales.**
- Si la puerta derecha es más alta, insertar una **cuña (AIX)** debajo las esquinas delantera izquierda y trasera derecha hasta que las puertas queden a la misma altura. **Quebrantar cualquier exceso de las cuñas.**

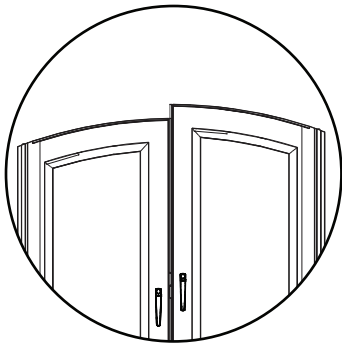

Fig. 1

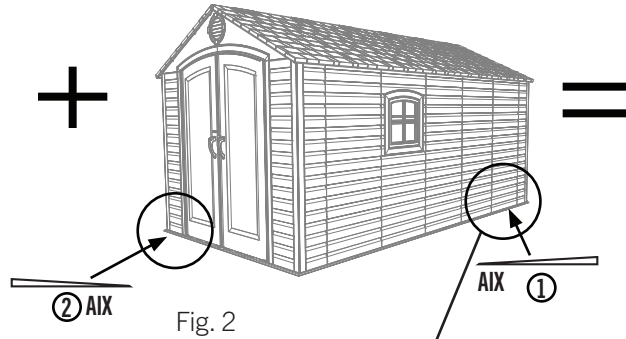

Fig. 2

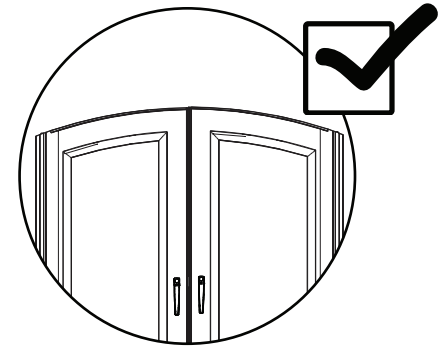
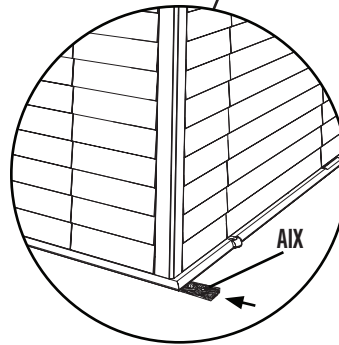

Fig. 3



AIX (x4)



# 13

## SLED ANCHORING / ANCRAGE DE L'ABRI / ANCLAJE DE LA CASETA



### HARDWARE REQUIRED / QUINCAILLERIE REQUISE / HERRAJE REQUERIDO



### PARTS REQUIRED / PIÈCES REQUISES / PIEZAS REQUERIDAS



### TOOLS REQUIRED (NOT INCLUDED—UNLESS INDICATED OTHERWISE\*) / OUTILS REQUIS (NON INCLUS—SAUF INDICATION CONTRAIRE\*) / INSTRUMENTAL REQUERIDO (NO INCLUIDO, SALVO INDICACIÓN CONTRARIA\*)

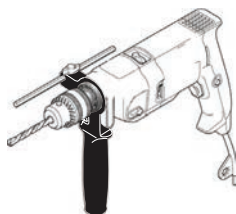

7/16 in/po (≈11 mm)



5/16 in/po (≈8 mm) Wood Drill Bit  
5/16 in/po (≈8 mm) Foret à bois  
5/16 in/po (≈8 mm) Broca para madera



5/16 in/po (≈8 mm) Masonry Drill Bit  
5/16 in/po (≈8 mm) Foret à maçonnerie  
5/16 in/po (≈8 mm) Broca para albañilería

## ► SECTION 13 (CONTINUED) / SECTION 13 (SUITE) / SECCIÓN 13 (CONTINUACIÓN)

FOR A CONCRETE PLATFORM / PARA UNA PLATAFORMA DE CONCRETO / POUR UNE PLATE-FORME EN BÉTON



5/16 in/po (≈8 mm)

### 13.1

- To anchor your shed, you must purchase the correct anchoring hardware. **For a concrete platform**, we recommend using a hammer drill, 5/16 in (≈8 mm) masonry bit, twelve (12) 3/8 in x 2 in (≈10 mm x ≈5 cm) concrete screws and twelve (12) 3/8 in x 1 in (≈10 mm x ≈2,5 cm) fender washers.
- Pour ancrer l'abri, il faut acheter la quincaillerie d'ancrage correcte. **Pour une plate-forme en béton**, nous recommandons l'usage d'une perceuse de percussion, un foret à maçonnerie de 5/16 po (≈8 mm), douze (12) vis d'ancrage à béton de 3/8 po x 2 po (≈10 mm x ≈5 cm) et douze (12) rondelles de protection de 3/8 po x 1 po (≈10 mm x ≈2,5 cm).
- Para anclar la caseta, es necesario comprar el herraje de anclaje correcto. **Para una plataforma de concreto**, recomendamos el uso de un martillo perforador, broca de albañilería de 5/16 in (≈8 mm), doce (12) tornillos de anclaje para concreto de 3/8 in x 2 in (≈10 mm x ≈5 cm) y doce (12) rondanas de protección de 3/8 in x 1 in (≈10 mm x ≈2,5 cm).



- Do not exceed a 3/8 in (≈10 mm) diameter screw. Refer to your local hardware store for this hardware.
- Ne pas dépasser un diamètre de 3/8 po (≈10 mm). Une quincaillerie locale aura ces accessoires.
- No exceda un diámetro de 3/8 in (≈10 mm). Referirse a su ferretería local para obtener estos elementos.

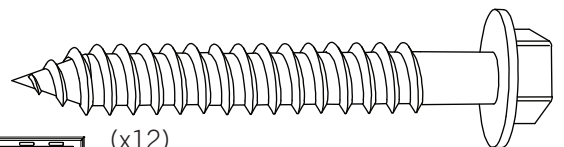

(x12)

(Not included) (Non incluses) (No incluidos)

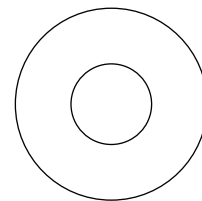
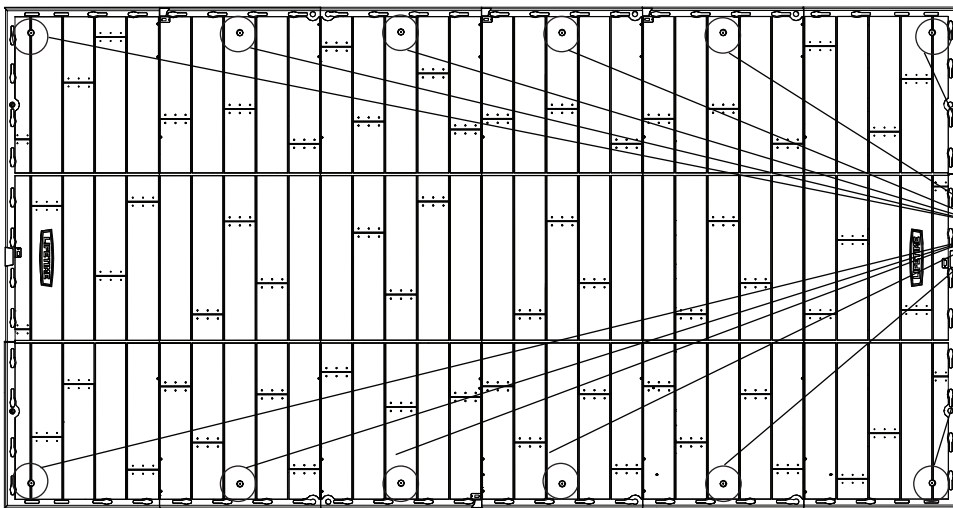

(x12)

(Not included) (Non incluses) (No incluidos)



### WARNING / AVERTISSEMENT / ADVERTENCIA



- Failure to anchor the shed may result in property damage and/or personal injury.
- Si vous n'ancrez pas votre abri, des dommages à la propriété et/ou des blessures peuvent en résulter.
- No anclar la caseta puede resultar en daños a la propiedad y/o en lesiones personales.



## ► SECTION 13 (CONTINUED) / SECTION 13 (SUITE) / SECCIÓN 13 (CONTINUACIÓN)

FOR WOOD PLATFORM / PARA UNA PLATAFORMA DE MADERA / POUR UNE PLATE-FORME EN BOIS



7/16 in/po (≈11 mm)



5/16 in/po (≈8 mm)

### 13.1

- To anchor your shed, you must purchase the correct anchoring hardware. **For a wood-framed platform**, we recommend using a drill, 5/16 in (≈8 mm) drill bit, twelve (12) 3/8 in x 1 1/2 in (≈10 mm x ≈4 cm) lag screws and twelve (12) 3/8 in x 1 in (≈10 mm x ≈2,5 cm) fender washers.
- Pour ancrer l'abri, il faut acheter la quincaillerie d'ancrage correcte. **Pour une plate-forme en bois**, nous recommandons l'usage d'une perceuse électrique, un foret de 5/16 po (≈8 mm), douze (12) vis de retard de 3/8 po x 1 1/2 po (≈10 mm x ≈4 cm), et douze (12) rondelles de protection de 3/8 po x 1 po (≈10 mm x ≈2,5 cm).
- Para anclar la caseta, es necesario comprar el herraje de anclaje correcto. **Para una plataforma hecho de hecho de madera**, recomendamos el uso de un taladro eléctrico, una broca de 5/16 in (≈8 mm), doce (12) tornillos para madera de 3/8 in x 1 1/2 in (≈10 mm x ≈4 cm) y doce (12) rondanas de protección de 3/8 in x 1 in (≈10 mm x ≈2,5 cm).



- Do not exceed a 3/8 in (≈10 mm) diameter screw. Refer to your local hardware store for this hardware.
- Ne pas dépasser un diamètre de 3/8 po (≈10 mm). Une quincaillerie locale aura ces accessoires.
- No exceda un diámetro de 3/8 in (≈10 mm). Referirse a su ferretería local para obtener estos elementos.

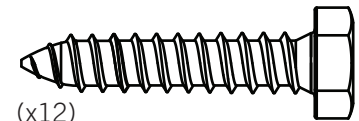
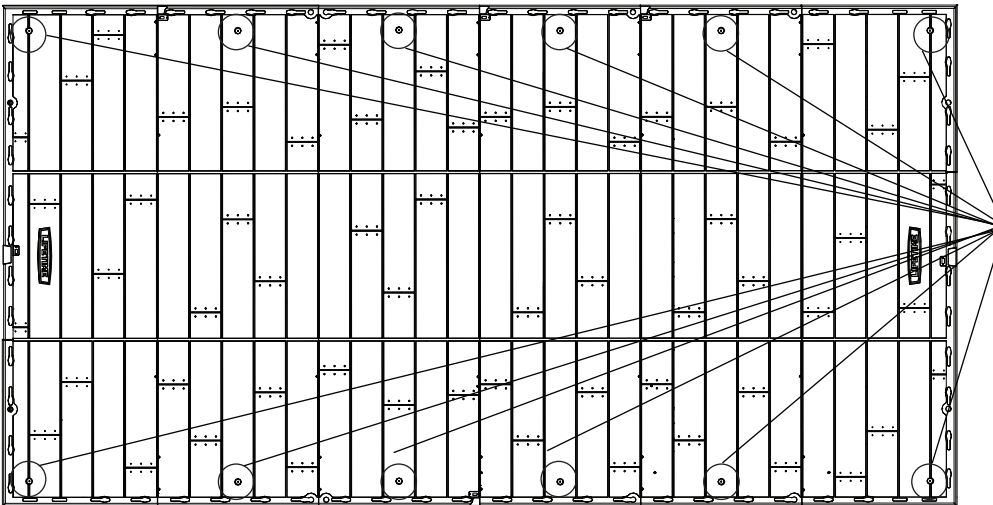

(x12)

(Not included) (Non incluses) (No incluidos)

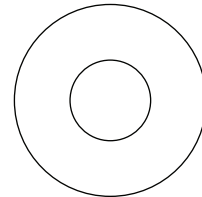

(x12)

(Not included) (Non incluses) (No incluidos)



### WARNING / AVERTISSEMENT / ADVERTENCIA



- Failure to anchor the shed may result in property damage and/or personal injury.
- Si vous n'ancrez pas votre abri, des dommages à la propriété et/ou des blessures peuvent en résulter.
- No anclar la caseta puede resultar en daños a la propiedad y/o en lesiones personales.



## CLEANING & CARE

**Congratulations on your Lifetime® product purchase. By following the instructions below, your new Lifetime product should provide you with years of service and enjoyment.**

The polyethylene panels are stain- and solvent-resistant. Most stains can be removed using a mild soap and a soft-bristled brush. Abrasive cleaning materials may scratch the plastic and are not recommended. Repair scratches or rust spots on the metal by sanding the affected area lightly; using a rust preventative spray primer; and finally, spraying with a high-gloss spray enamel paint. Avoid placing a direct heat source on or near surfaces unless using a heat barrier.



## NETTOYAGE ET ENTRETIEN

**Nous vous félicitons d'avoir acheté ce produit Lifetime®. En suivant les instructions ci-dessous, votre nouvel produit Lifetime devrait vous fournir des années de service et de plaisir.**

Les murs et les étagères en polyéthylène sont résistants aux tâches et solvants de nettoyage. Pour les nettoyer, servez-vous d'un savon doux et d'une brosse douce. Les produits abrasifs de nettoyage risquent d'égratigner le plastique et ne sont pas recommandés. Pour réparer les égratignures ou tâches de rouille sur le métal, frottez légèrement l'endroit affecté ou papier de verre, puis passez un couche de produit vaporisant préventif et enfin vaporisez une peinture émail brillant élevé. Évitez de placer une source de chaleur directe sur ou près des surfaces, ou protégez-les à l'aide d'une protection contre la chaleur.



## LIMPIEZA Y CUIDADO

**Felicidades por la compra de su producto Lifetime®. Al seguir las siguientes instrucciones, su nuevo producto Lifetime le brindará años de servicio y satisfacción.**

Los paneles de polietileno son resistentes a las manchas y solventes. La mayoría de las manchas puede removerse usando un jabón suave y un cepillo de cerdas suaves. Los materiales abrasivos para limpieza pueden rayar el plástico y no se recomiendan. Repare rayones o manchas de óxido en el metal, lijando suavemente la parte afectada; usando un aerosol preventivo de óxido y finalmente, rociando con una pintura de esmalte brillante. Evite poner una fuente de calor directa en o cerca de las superficies a menos que utilice una barrera de calor.



## REGISTER YOUR PRODUCT ONLINE AT WWW.LIFETIME.COM

At Lifetime®, we are committed to providing innovative and quality products. While registering, you will have the opportunity to give us your feedback. Your input is valuable to us.

- You can also opt in to receive new product notifications or promotions.
- In the unlikely event of a product recall or safety modification, your registration provides the information we need to notify you directly.
- Registration is fast, easy, and completely voluntary.

### LIFETIME'S PROMISE TO YOU:

*Maintaining your privacy is our long-standing policy at Lifetime®. And you can rest assured that Lifetime® will not sell or provide your personal data to other third parties, or allow them to use your personal data for their own purposes.*

We invite you to read our privacy policy at [www.lifetime.com](http://www.lifetime.com)

**REGISTER today!**



## ENREGISTRER CE PRODUIT EN LIGNE À WWW.LIFETIME.COM

Chez Lifetime®, nous nous engageons à fournir des produits innovateurs de qualité. Lors de votre inscription, vous aurez l'occasion de nous faire parvenir vos commentaires. Votre opinion est importante pour nous.

- On peut également choisir de recevoir des avis ou des promotions dans le cadre de nouveaux produits.
- Dans l'éventualité improbable d'un rappel ou d'un avis de sécurité, l'inscription fournit les renseignements nécessaires nous permettant de communiquer avec vous.
- L'inscription est rapide, facile et complètement volontaire.

### LA PROMESSE DE LIFETIME:

*Conserver votre confidentialité est notre politique de longue date chez Lifetime®. Vous pouvez donc être rassuré par le fait que Lifetime® ne vendra pas ou ne fournira pas vos données personnelles à des tiers, et ne leur permettra pas d'utiliser vos données personnelles à leurs propres fins.*

Nous vous invitons à lire notre politique de confidentialité à [www.lifetime.com](http://www.lifetime.com) (en anglais seulement)

**ENREGISTRER CE PRODUIT aujourd'hui!**



## REGISTRAR EL PRODUCTO EN LÍNEA EN WWW.LIFETIME.COM

En Lifetime®, estamos comprometidos a ofrecer productos innovadores y de calidad. Al registrarse, usted tendrá la oportunidad de darnos su retroalimentación. Su información es valiosa para nosotros.

- También puede optar por recibir nuestras notificaciones o promociones.
- En el caso improbable de que el producto deba ser retirado del mercado o que sufra alguna modificación, su registro provee la información que necesitamos para notificarle directamente.
- El registro es rápido, fácil y completamente voluntario.

### LA PROMESA DE LIFETIME® PARA USTED:

*Mantener privacidad es nuestra política permanente en Lifetime®. Y puede estar seguro que Lifetime® no venderá ni dará datos personales a terceros, ni les permitirá usar datos personales para sus propios fines.*

Lo invitamos a leer nuestra política de privacidad en [www.lifetime.com](http://www.lifetime.com) (sólo en inglés)

**¡REGISTRARSE hoy mismo!**



NOTES / REMARQUES / NOTAS

A large, empty white rectangular area intended for writing notes or remarks.



## 10-YEAR LIMITED FACTORY WARRANTY

**THE MANUFACTURER RESERVES THE RIGHT TO MAKE SUBSTITUTIONS TO WARRANTY CLAIMS IF PARTS ARE UNAVAILABLE OR OBSOLETE.**

Lifetime Lawn and Garden products are warranted to the original purchaser to be free from defects in material or workmanship for a period of 10 years from the date of original retail purchase. The word “defects” is defined as imperfections that impair the use of the product. Defects resulting from misuse, abuse or negligence will void this warranty. This warranty does not cover defects due to improper installation, alteration or accident. Lifetime recommends that no modifications be made to this product. This warranty does not cover damage caused by vandalism, rusting, “acts of nature”, natural disasters, normal wear and tear, or any other event beyond the control of the manufacturer.

This warranty is nontransferable and is expressly limited to the repair or replacement of defective products. If the product is defective within the terms of this warranty, Lifetime Products, Inc. will repair or replace defective parts at no cost to the purchaser. Shipping charges to and from the factory or distribution center are not covered and are the responsibility of the purchaser. Labor charges and related expenses for removal, installation or replacement of the product or its components are not covered under this warranty.

This warranty does not cover scratching, scuffing, or other cosmetic damage of the product that may result from normal usage. In addition, defects resulting from intentional damage, negligence, or unreasonable use will void this warranty / are not covered by this warranty.

Liability for incidental or consequential damages is excluded to the extent permitted by law. All merchandise is sold on this condition, and no representative of the company may waive or change this policy. This product is not intended for institutional or commercial use; Lifetime Products, Inc. does not assume any liability for such use. Institutional or commercial use will void the warranty.

This warranty is expressly in lieu of all other warranties, expressed or implied, including warranties of merchantability or fitness for use to extent permitted by Federal and state law. Neither Lifetime Products, Inc., nor any representative assumes any other liability in connection with this product. This warranty gives you specific legal rights, and you may also have other rights which vary from state to state.

Our goods come with guarantees that cannot be excluded under the Australian Consumer Law. You are entitled to a replacement or refund for a major failure and for compensation for any other reasonably foreseeable loss or damage. You are also entitled to have the goods repaired or replaced if the goods fail to be of acceptable quality and the failure does not amount to a major failure.

**ALL WARRANTY CLAIMS MUST BE ACCOMPANIED BY A SALES RECEIPT.  
REPORT PRODUCT DEFECTS IN WRITING TO:**

LIFETIME PRODUCTS, INC.,  
PO Box 160010  
Freeport Center, Bldg. D-12  
Clearfield, UT 84016-0010

For online warranty claims, please visit: [www.lifetime.com/warranty](http://www.lifetime.com/warranty)  
Warranty Department: (800) 225-3865

**FOR INTERNATIONAL WARRANTY:**

All warranty claims must be accompanied by a sales receipt. Report product defects in writing to your regional sales support representative. Please include your dated sales receipt and photographs of damaged parts.

To Identify the representative for your region, please visit: [www.lifetime.com/international](http://www.lifetime.com/international)



## GARANTIE DE FABRICATION LIMITÉE DE 10 ANS

**LIFETIME® PRODUCTS, INC. RÉSERVE LE DROIT DE FAIRE DES SUBSTITUTIONS EN CAS DE RECOURS EN GARANTIE SI LES PIÈCES NE SONT PAS DISPONIBLES OU SONT OBSOÈTES.**

L'acheteur d'origine des produits pour pelouses et jardins de Lifetime bénéficie d'une garantie contre toute défectuosité de matériel et de fabrication pour une période de 10 ans à compter de la date d'achat. On entend par « défaut » une imperfection qui nuit à l'utilisation du produit. Tout défaut découlant d'une mauvaise utilisation, d'un abus ou d'une négligence a pour effet d'annuler cette garantie. Cette garantie ne couvre pas les défauts attribuables à une installation inadéquate, une altération ou un accident. Lifetime recommande de ne pas apporter de modifications à ce produit. Cette garantie ne couvre pas les dommages causés par le vandalisme, la corrosion par la rouille, les cas de « force majeure », les catastrophes naturelles, la détérioration et l'usure normales et tout autre événement indépendant de la volonté du fabricant.

Cette garantie n'est pas transférable et se limite expressément à la réparation ou au remplacement d'un produit défectueux. Si le produit est défectueux au sens de cette garantie, Lifetime Products, Inc. réparera ou remplacera les pièces défectueuses sans frais pour l'acheteur. Les frais d'expédition en partance ou en provenance de l'usine ou du centre de distribution ne sont pas couverts et incombent à l'acheteur. Les coûts relatifs à la main-d'œuvre et les autres frais liés au retrait, à l'installation ou au remplacement du produit ou de ses composants ne sont pas couverts par cette garantie.

Cette garantie ne couvre pas les rayures, les égratignures ou autres dommages esthétiques du produit découlant d'un usage normal. De plus, tout défaut découlant d'un dommage volontaire, de négligence ou d'un usage déraisonnable annule cette garantie et n'est pas couvert par cette garantie.

Dans la mesure permise par la loi, la société n'est pas responsable des dommages indirects ou accessoires. Toute marchandise est vendue à cette condition et aucun représentant de la société ne peut renoncer à l'application de cette politique ou la modifier. Ce produit n'est pas destiné à des fins institutionnelles ou commerciales; Lifetime Products, Inc. n'assume aucune responsabilité à cet égard. Toute utilisation institutionnelle ou commerciale annule la garantie.

La présente garantie remplace expressément toute autre garantie, expresse ou implicite, y compris les garanties de qualité marchande ou d'adaptation à un usage particulier dans la mesure permise par les lois du pays ou de l'État. Ni Lifetime Products, Inc. ni aucun de ses représentants n'assument une quelconque responsabilité en lien avec ce produit. Cette garantie vous donne des droits juridiques précis et vous pourriez également avoir d'autres droits selon l'État ou la province.

La garantie qui accompagne nos produits ne peut être exclue en vertu de la loi sur la protection du consommateur de l'Australie. Le client a droit à un remplacement ou à un remboursement en cas de bris majeur et pour toute autre perte ou dommage raisonnablement prévisible. Le client a aussi droit à ce que les produits soient réparés ou remplacés si un bris survient et rend la qualité inacceptable sans pour autant être qualifiable de bris majeur.

**TOUTE RÉCLAMATION EN VERTU DE LA GARANTIE DOIT ÊTRE ACCOMPAGNÉE D'UN REÇU DE VENTE. SIGNALEMENT ÉCRIT DE TOUT PRODUIT DÉFECTUEUX:**

LIFETIME PRODUCTS, INC.,  
PO Box 160010  
Freeport Center, Bldg. D-12  
Clearfield, UT 84016-0010

Pour effectuer en ligne une réclamation sous garantie, consultez cette adresse : [www.lifetime.com/warranty](http://www.lifetime.com/warranty)  
Service de la garantie : (800) 225-3865

### **GARANTIE INTERNATIONALE:**

Toute réclamation en vertu de la garantie doit être accompagnée d'un reçu de vente. Veuillez signaler par écrit tout produit défectueux au représentant du soutien aux ventes de votre région. Veuillez inclure le reçu de vente daté ainsi que des photographies des pièces endommagées.

Pour connaître le représentant de votre région, veuillez consulter le : [www.lifetime.com/international](http://www.lifetime.com/international)



## GARANTÍA DE FÁBRICA LIMITADA POR 10 AÑOS

### **EL FABRICANTE SE RESERVA EL DERECHO DE HACER SUSTITUCIONES EN LOS ELEMENTOS REEMPLAZADOS BAJO GARANTÍA SI LAS PIEZAS NO ESTÁN DISPONIBLES O SON OBSOLETAS.**

El comprador original recibe una garantía de que los productos de césped y jardín de Lifetime están libres de defectos de material o mano de obra durante un período de 10 años a partir de la fecha de compra original al por menor. La palabra "defectos" se define como imperfección que imposibilita el uso del producto. Los defectos ocasionados por el mal uso, el abuso o la negligencia anularán esta garantía. Esta garantía no cubre los defectos debidos a una instalación incorrecta, una alteración o un accidente. Lifetime recomienda que no se realicen modificaciones en este producto. Esta garantía no cubre los daños causados por vandalismo, oxidación, "actos de la naturaleza", desastres naturales, desgaste normal o cualquier otro evento fuera del control del fabricante.

Esta garantía no es transferible y se limita expresamente a la reparación o reemplazo de productos defectuosos. Si el producto resulta defectuoso dentro de los términos de esta garantía, Lifetime Products, Inc. reparará o reemplazará las piezas defectuosas sin costo alguno para el comprador. Los gastos de envío hacia y desde la fábrica o el centro de distribución no están cubiertos y son la responsabilidad del comprador. La mano de obra y los gastos relacionados por la remoción, la instalación o la sustitución del producto o sus componentes no están cubiertos por esta garantía.

Esta garantía no cubre los rayones, los raspones ni otros daños superficiales del producto que pueden resultar del uso normal. Asimismo, los defectos resultantes de daños intencionales, negligencia o uso indebido anularán o no están cubiertos por esta garantía.

Se excluye la responsabilidad por daños imprevistos o derivados en la medida en que lo permita la ley. Toda la mercancía se vende bajo estas condiciones y ningún representante de la empresa puede renunciar a ni cambiar esta política. Este producto no está destinado para uso institucional o comercial; Lifetime Products, Inc. no asume ninguna responsabilidad por dicho uso. El uso institucional o comercial anulará la garantía.

Esta garantía sustituye expresamente cualquier otra garantía, expresa o implícita, incluidas las garantías de comercialización o idoneidad para su uso en la medida permitida por la ley federal y estatal. Ni Lifetime Products, Inc., ni ningún representante asume ninguna otra responsabilidad en relación con este producto. Esta garantía le otorga derechos legales específicos y usted también puede tener otros derechos que varían de un estado a otro.

Nuestros productos vienen con garantías que no se pueden excluir bajo la Ley Australiana del Consumidor. Usted tiene derecho a recibir un reemplazo o reembolso por un fallo grave y compensación por cualquier otra pérdida o daño razonablemente previsible. También tiene derecho a la reparación o el reemplazo de los bienes si los bienes no son de calidad aceptable y el fallo no supone un fallo grave.

### **TODOS LOS RECLAMOS DE GARANTÍA DEBEN ESTAR ACOMPAÑADOS POR UN RECIBO DE COMPRA. REPORTE LOS DEFECTOS DEL PRODUCTO POR ESCRITO A:**

LIFETIME PRODUCTS, INC.,  
PO Box 160010  
Freeport Center, Bldg. D-12  
Clearfield, UT 84016-0010

Para realizar reclamos de garantía por internet, visite: [www.lifetime.com/warranty](http://www.lifetime.com/warranty).  
Departamento de Garantías: (800) 225-3865

### **PARA LA GARANTÍA INTERNACIONAL:**

Todos los reclamos de garantía deben estar acompañados por un recibo de compra. Reporte los defectos del producto por escrito a su representante regional de apoyo de ventas. Por favor, incluya su recibo de compra con la fecha y fotografías de las piezas dañadas.

Para identificar al representante de su región, por favor visite: [www.lifetime.com/international](http://www.lifetime.com/international)

### **GARANTIA NO VÁLIDA EN MÉXICO**

**ENHANCE YOUR LIFETIME® PURCHASE BY ADDING ACCESSORIES OR OTHER GREAT PRODUCTS**

*To purchase accessories or other Lifetime® products, visit us at:*

***www.lifetime.com***

*Or call 1-800-424-3865*

**AMÉLIORER VOTRE ACHAT LIFETIME® EN AJOUTANT DES ACCESSOIRES OU D'AUTRES PRODUITS**

*Pour acheter des accessoires ou d'autres produits Lifetime®, nous rendre visite à :*

***www.lifetime.com***

*Ou composer le 1-800-424-3865*

**MEJORAR SU COMPRA LIFETIME® Y AÑADIR ACCESORIOS U OTROS PRODUCTOS EXCELENTES**

*Para comprar accesorios u otros productos Lifetime® EUA, visitarnos en:*

***www.lifetime.com***

*O marcar al 1-800-424-3865*

