



MANUEL D'INSTRUCTIONS INSTRUCTION MANUAL

FLORENCE - 12 x 15 TOIT D'ACIER
FLORENCE - 12x15 METAL ROOF

sku: 41215MR-GP-12		
sku: 41215MR-GP-32		

**DE NE PAS DÉTRUIRE LES BOÎTES AVANT FINIR L'INSTALLATION AU COMPLET
POUR LA RÉFÉRENCE FUTURE, PRENEZ DES PHOTOS DE TOUS LES SIX CÔTÉS DE
CHACUN DES BOÎTES À LA RÉCEPTION DU PRODUIT.**

SVP, VÉRIFIEZ LE CONTENU DE CHAQUE BOÎTE VS LA LISTE DES PIÈCES DÉTAILLÉE

12pi x 15pi / 3.66m x 3.66m Meters Solarium

LES INSTRUCTIONS D'INSTALLATION

IMPORTANT: RETENIR POUR LA FUTURE RÉFÉRENCE, LIRE ATTENTIVEMENT

Consultez votre autorité locale / les codes municipaux locaux concernant l'installation de structures temporaires avant l'achat ou l'assemblage. Certaines juridictions peuvent exiger des permis pour, ou réglementer autrement, l'installation et l'utilisation.

Pour l'assistance de l'assemblage, d'installation, des pièces en particulier, ou service à la clientèle, veuillez contacter Gazebo Penguin au numéro de téléphone mentionné mi-bas : (français, anglais, lun. à ven. de 8 du matin à 4 après-midi est) :

Montréal: (514) 276-3485

Canada et États-Unis: 1-800-737-7174

ATTENTION:

- Pour une utilisation à l'extérieur.
- La neige doit être nettoyée en tout le temps, de ne pas laisser s'accumuler.
- Retenir votre **preuve d'achat** pour la garantie. Veuillez **garder les boîtes** jusqu'à d'avoir fini l'installation correctement au complet.
- D'assemblage peut durer plus que 4 heures et l'exige d'avoir au moins 3 personnes.



AVANT ASSEMBLAGE:

- Veuillez ne pas détruire les boîtes avant d'avoir fini complètement assemblage.
- La fondation doit être sous le niveau de sol, plat et solide, comme du béton ou de l'asphalte.
- Tenez à l'écart des lignes électriques aériennes, des branches d'arbres et d'autres structures.
- Vérifiez s'il y a des tuyaux ou des fils souterrains si le creusement ou le forage est nécessaire.
- Ne pas installer à proximité des lignes de toit ou d'autres structures qui pourraient jeter de la neige, de la glace ou une pluie excessive sur le toit.
- Assemblez la structure près du point final d'utilisation la plus proche possible.
- Il est recommandé de porter des gants de sécurité, des lunettes de sécurité et des casques de protection pour l'installation.
- Ne vous suspendez pas, ne grimpez pas et ne vous tenez pas debout sur la structure ou le toit.
- Avant le montage, lisez les instructions et vérifiez que toutes les pièces sont présentes dans les boîtes. S'il manque des pièces, svp, contactez notre département de garantie.
- Un escabeau de 6 pieds (1,8 m), un tournevis Phillips, un ruban à mesurer, un niveau, un maillet et une bâche sur laquelle placer les pièces seront nécessaires pour l'assemblage (non inclus).
- Enlevez le film protecteur supérieur des panneaux de toit avant l'assemblage; NE PAS retirer le film protecteur inférieur avant d'être prêt à insérer les panneaux de toit, afin d'identifier le côté supérieur.

INSTRUCTION D'ANCRAGE:

- Un ancrage adéquat du cadre à la base et au mur est nécessaire pour la sécurité.
- Une structure non solidement ancrée a un risque de s'envoler lors de vents violents causant des dommages et des risques pour la sécurité.
- Le matériel et les outils requis pour l'ancrage varient en fonction de l'emplacement d'installation et ne sont pas fournis.
- Veuillez vérifier auprès de votre quincaillerie locale les ancrages appropriés à votre surface.
- Ne pas ancrer aux pavés / dalles de chaussée car ils ne constituent pas une fondation solide.

SOIN ET MAINTENANCE:

- En cas de pièce défectueuse ou endommagée, ou pour toute autre question concernant le produit, veuillez contacter directement le fabricant.
- Veuillez avoir la liste des pièces et les numéros de pièces à portée de main lors de la commande ou de la demande de pièces de rechange.











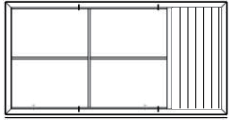

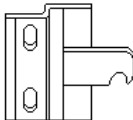
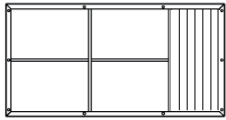
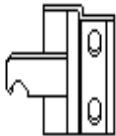
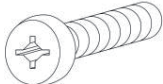

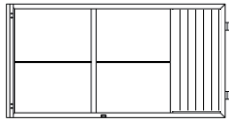
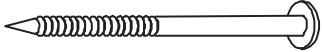

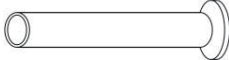

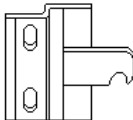
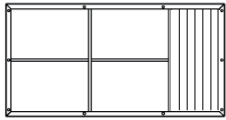
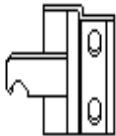
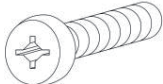
PANNEAUX DE TOIT:

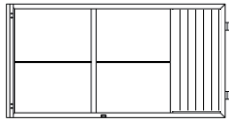
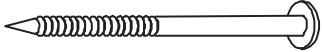

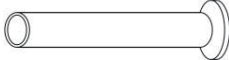
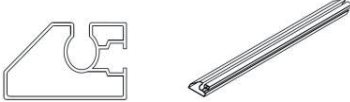
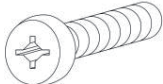

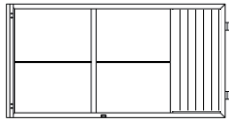
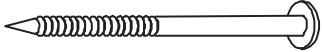

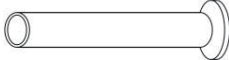
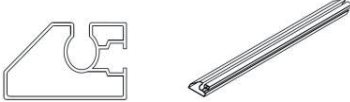

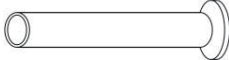
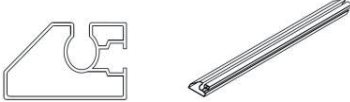

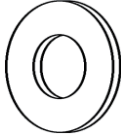
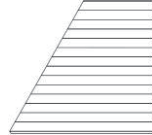
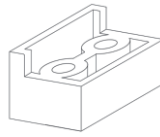
- Nettoyez doucement avec une solution savonneuse écologique et de l'eau à l'aide d'une éponge.
- N'utilisez pas de matériaux abrasifs, de brosses métalliques, de produits chimiques, de nettoyeurs puissants ou d'eau de javel.
- Rincer à l'aide d'un tuyau d'arrosage et sécher à l'air. S'il est retiré, assurez-vous qu'il est complètement sec avant le stockage.
- N'utilisez pas de nettoyeur haute pression.

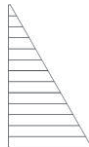

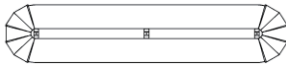

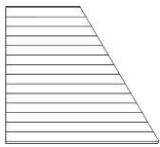

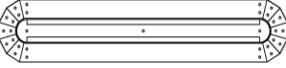
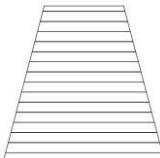
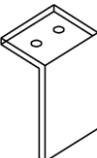



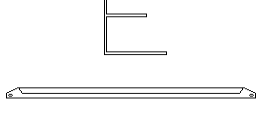

STRUCTURE:



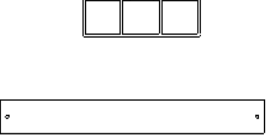
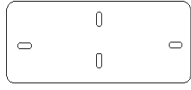

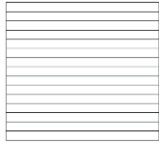
- Nettoyez doucement avec une solution savonneuse écologique et de l'eau à l'aide d'une éponge.
- N'utilisez pas de matériaux abrasifs, de brosses métalliques, de produits chimiques, de nettoyeurs puissants ou d'eau de javel.
- Rincer à l'aide d'un tuyau d'arrosage et sécher à l'air. N'utilisez pas de nettoyeur haute pression.
- S'il y a des imperfections voir le numéro de pièce de la peinture dans la liste des pièces pour obtenir une peinture de retouche correspondante.

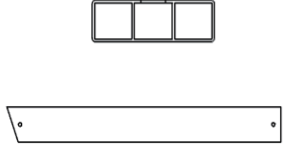
12 x 15 Solarium

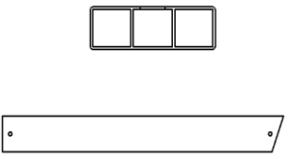
DESCRIPTION	EMBALLE DANS LA BOITE	QUANTITE	SCHEMA	DESCRIPTION	EMBALLE DANS LA BOITE	QUANTITE	SCHEMA																																																
08-129-12 CADRE REGULIER A	3	5		08-132-12 CADRE DE PORTE D	3	1																																																	
	4	5			4	1		17-054-12 PANNEAU DE TOIT Aa	1	4		08-165-12 LOQUET DE PORTE Dd-R	5	2		08-130-12 CADRE ADJACENT (trous additionnels) B	3	1		08-169-12 LOQUET DE PORTE Dd-L	5	2		4	1	08-158-12 VIS M6*16 Bb	5	124		08-133-12 PIECE DE CONNEXION E	5	12		08-131-12 PORTE COULISSANTE C	3	1		08-167-12 VIS M6*63.5 Ee	5	24		4	1	08-161-12 VIS M6*73 Cc	5	12		08-136-12 RAIL DE PORTE F	5	2		12-037-12 ECROU M5*60 Cc-2	5	12	
17-054-12 PANNEAU DE TOIT Aa	1	4		08-165-12 LOQUET DE PORTE Dd-R	5	2																																																	
08-130-12 CADRE ADJACENT (trous additionnels) B	3	1		08-169-12 LOQUET DE PORTE Dd-L	5	2																																																	
	4	1						08-158-12 VIS M6*16 Bb	5	124		08-133-12 PIECE DE CONNEXION E	5	12		08-131-12 PORTE COULISSANTE C	3	1		08-167-12 VIS M6*63.5 Ee	5	24		4	1	08-161-12 VIS M6*73 Cc	5	12		08-136-12 RAIL DE PORTE F	5	2		12-037-12 ECROU M5*60 Cc-2	5	12		08-137-12 RAIL DE PORTE G	5	2															
08-158-12 VIS M6*16 Bb	5	124		08-133-12 PIECE DE CONNEXION E	5	12																																																	
08-131-12 PORTE COULISSANTE C	3	1		08-167-12 VIS M6*63.5 Ee	5	24																																																	
	4	1						08-161-12 VIS M6*73 Cc	5	12		08-136-12 RAIL DE PORTE F	5	2		12-037-12 ECROU M5*60 Cc-2	5	12		08-137-12 RAIL DE PORTE G	5	2																																	
08-161-12 VIS M6*73 Cc	5	12		08-136-12 RAIL DE PORTE F	5	2																																																	
12-037-12 ECROU M5*60 Cc-2	5	12		08-137-12 RAIL DE PORTE G	5	2																																																	

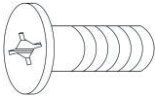
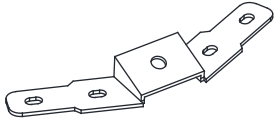
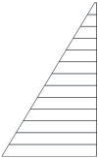
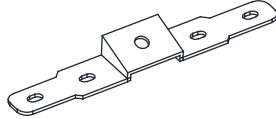
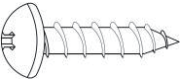
DESCRIPTION	EMBALLE DANS LA BOITE	QUANTITE	SCHEMA	DESCRIPTION	EMBALLE DANS LA BOITE	QUANTITE	SCHEMA
08-187-12 RONDELLE Gg	5	59		17-061-12 PANNEAU DE TOIT Kk	2	4	
08-138-12 BUTOIR PORTE H	5	4		17-044-12 CHEVRON 78.9" L	5	6	
08-189-12 ECROU Hh	5	3		17-057-12 PANNEAU DE TOIT LI	2	4	
08-139-12 PIECE DE CONNEXION 78.9" I	5	8		08-179-12 CAPUCHON EXTERIEUR M	5	1	
08-193-12 BOUCHON EN PLASTIQUE li	5	24		17-058-12 PANNEAU DE TOIT Mm	2	4	
08-140-12 PIECE DE CONNEXION 78.9" J	5	8		08-178-12 CAPUCHON INTERIEUR N	5	1	
17-055-12 PANNEAU DE TOIT Jj	1	4		08-134-12 CAPUCHON RAIL DE PORTE SUPERIEUR Nn	5	4	
17-043-12 CHEVRON 89.9" K	5	8		17-049-12 BARRE DE TOIT 88.9" O	5	8	

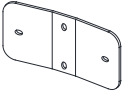
DESCRIPTION	EMBALLE DANS LA BOITE	QUANTITE	SCHEMA	DESCRIPTION	EMBALLE DANS LA BOITE	QUANTITE	SCHEMA
17-050-12 BARRE DE TOIT 78.5" O1	5	6		17-046-12 BARRE DE FINITION 45.3" S	5	4	
08-135-12 VIS Oo	5	4		17-068-12 BARRE DE FINITION 42.6" Ss	5	2	
16-118-12 VIS M6*36 Oo1	5	56		17-048-12 BARRE DE SOLIDIFICATION 20.8" T	5	4	
17-051-12 BARRE DE RECOUVREMENT 39.7" P	5	10		17-069-12 BARRE DE SOLIDIFICATION 39.4" Tt	5	2	
18-067-12 SUPPORT DE BARRE SOLIDIFIANTE Pp	5	6		17-045-12 BARRE DE FINITION 45.2" U	5	4	
17-075 PANNEAU DE TOIT Qq	1	2		17-071-12 BARRE DE FINITION 45.2" U1	5	4	
17-053-12 EMBOUT R	5	6		17-047-12 BARRE DE SOLIDIFICATION 20.8" V	5	4	
17-076-12 PANNEAU DE TOIT Rr	1	2		17-070-12 BARRE DE SOLIDIFICATION 20.8" V1	5	4	

DESCRIPTION	EMBALLE DANS LA BOITE	QUANTITE	SCHEMA	DESCRIPTION	EMBALLE DANS LA BOITE	QUANTITE	SCHEMA
12-047-12 VIS M5*15 Ww	5	12		15-124-12 ANGLE EN ACIER Z1 (assemblé au chevron)	5	8	
17-060-12 PANNEAU DE TOIT Y	2	4		15-125-12 ANGLE EN ACIER Z2 (assemblé au chevron)	5	6	
08-156-12 VIS M5*20 Z	5	56		23-003 BARRE DE RECOUVREME NT P-1	5	4	
23-004 SOLIDIFYING BAR BRACKET Pp-1	5	8		23-005 EMBOUIT R1	5	8	

***PAS INCLUS DANS LA BOITE**

DESCRIPTION	COULEUR	# DE PIÈCE
PEINTURE À SPRAY	SABLE	11-699
STYLO À PEINTURE		18-245

Avant d'assembler le solarium

- Ne détruisez pas les boîtes avant que l'abri soit complètement assemblé.
- Pour référence future, prenez des photos de tous les six côtés de chacune des boîtes à la réception du produit.
- Veuillez vérifier le contenu de chaque boîte à l'aide de la liste de pièces.

Outils nécessaires:

- Escabeau 6'-8'
- Tournevis Phillips #2, Tournevis Robertson #2 (non inclus)
- Maillet en caoutchouc
- Diverses limes
- Morceaux de bois 12"

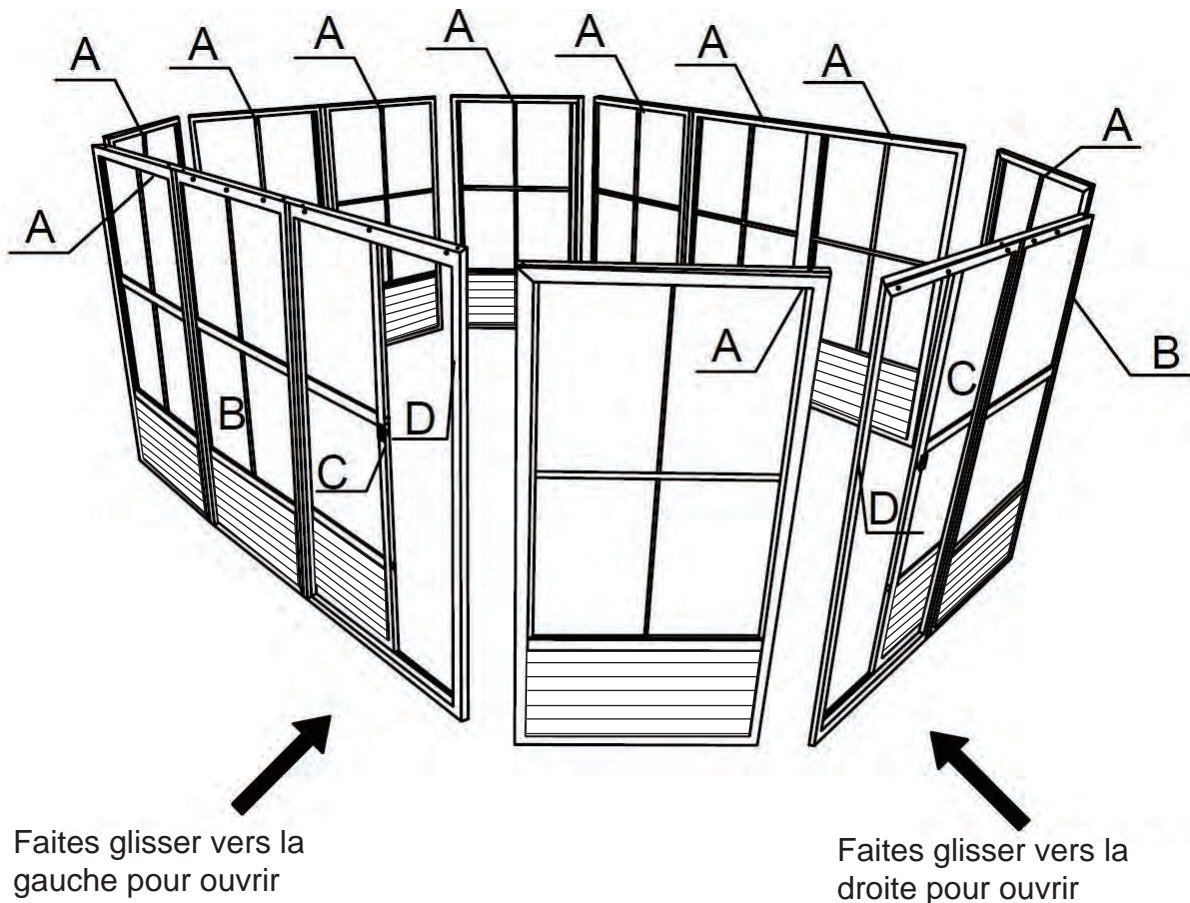

Selon l'emplacement, décidez où vous souhaitez placer les deux (2) panneaux de portes qui peuvent coulisser vers la gauche ou la droite, selon votre choix.

Étape 1:

Avant de commencer l'assemblage, veuillez décider où vous souhaitez placer les panneaux de porte.

1. Levez deux cadres (A), glissez de haut en bas et fixez les panneaux ensemble à l'aide de deux pièces de connexion (I, J).
2. Montez ensuite le cadre à côté de la porte (B) et à l'aide de la pièce de raccordement (E), connectez-le au cadre de porte A précédemment défini, comme illustré ci-dessous. De même, installez un cadre de porte (D) en plaçant le cadre de porte à gauche ou à droite, à l'aide de la pièce de connexion (E).
3. Lors de l'assemblage des panneaux inclinés (A), vous devez placer les deux panneaux à un angle de 135 degrés, puis utiliser les pièces de connexion inclinées (I) et (J) glisser de haut en bas pour fixer les panneaux ensemble.
4. La partie moustiquaire du cadre doit faire face à l'extérieur de l'unité.
5. Les rails du cadre de porte se trouvent à l'intérieur de l'unité.

Note : Lorsque vous faites glisser la partie I, J et E dans les cadres, secouez les cadres pour qu'ils glissent également. N'appliquez pas de force excessive. Assurez-vous que les bords sont propres de toute peinture supplémentaire si nécessaire, utilisez une lime fine.

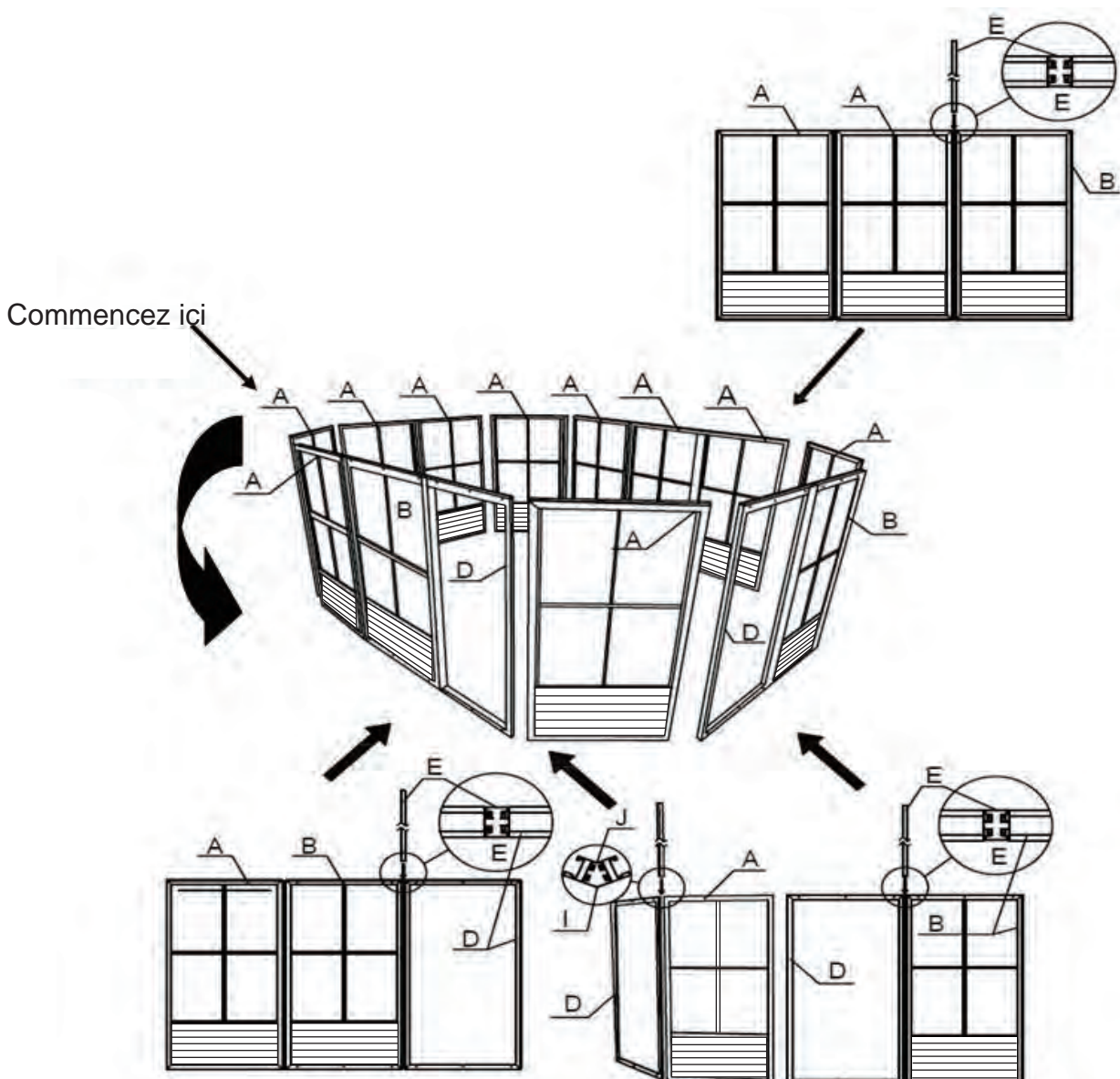

Étape 2:

1. Attachez les barres de recouvrement (P/P-1) en les faisant glisser sur le dessus de la rainure extérieure des cadres (A, B, D).

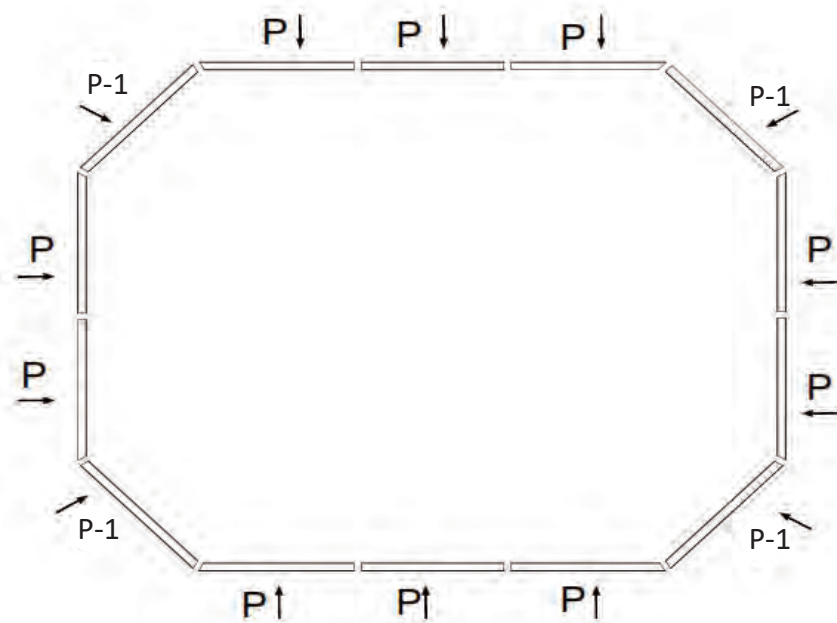
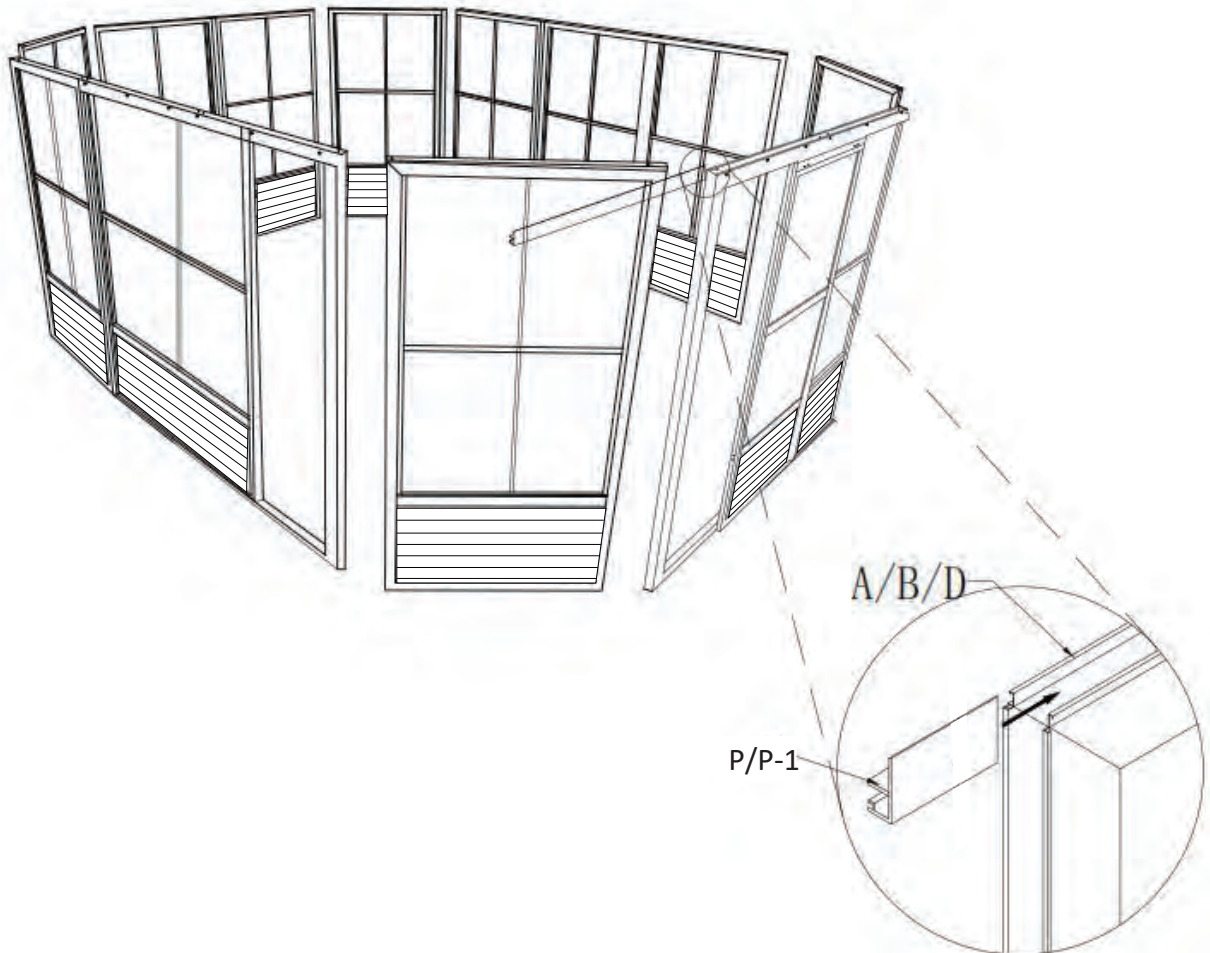

Étape 3:

1. Faites glisser le rail supérieur de la porte (F) dans les roues de la porte coulissante (C).
2. Faites glisser le rail inférieur de la porte (G) dans le guide en plastique de la porte coulissante (C).
3. Utilisez des boulons (Bb) pour attacher les bouchons en plastique (H), un à chaque extrémité du rail supérieur de la porte (F).
4. À l'aide d'une vis (Oo), attachez les capuchons d'extrémité (Nn), un à chaque côté du rail supérieur de porte (F).

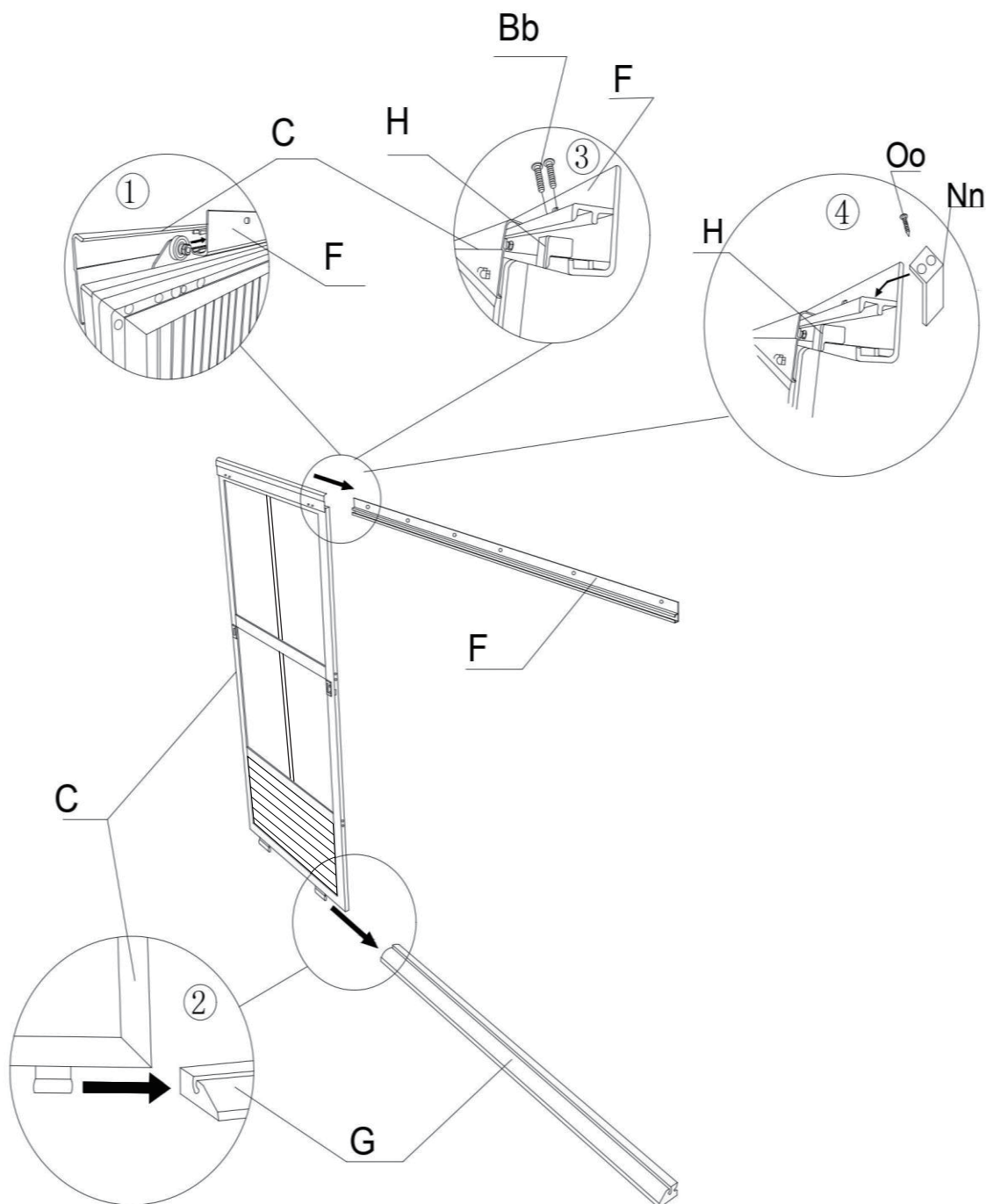

Étape 4:

Veillez noter que la porte coulissante est suggérée pour être installée de l'intérieur du solarium.

1. Placez un boulon (Ww) à travers le cadre supérieur de porte (D) et le rail supérieur de porte (F), et placez un boulon femelle (Cc-2) de l'autre côté. Une fois tous insérés, serrez-les fermement.
2. Sécurisez le rail inférieur de la porte (G) à l'aide d'un boulon (Cc) .
3. Utilisez le boulon (Bb) pour fixer le loquet de porte (Dd-R, Dd-L) sur le cadre.

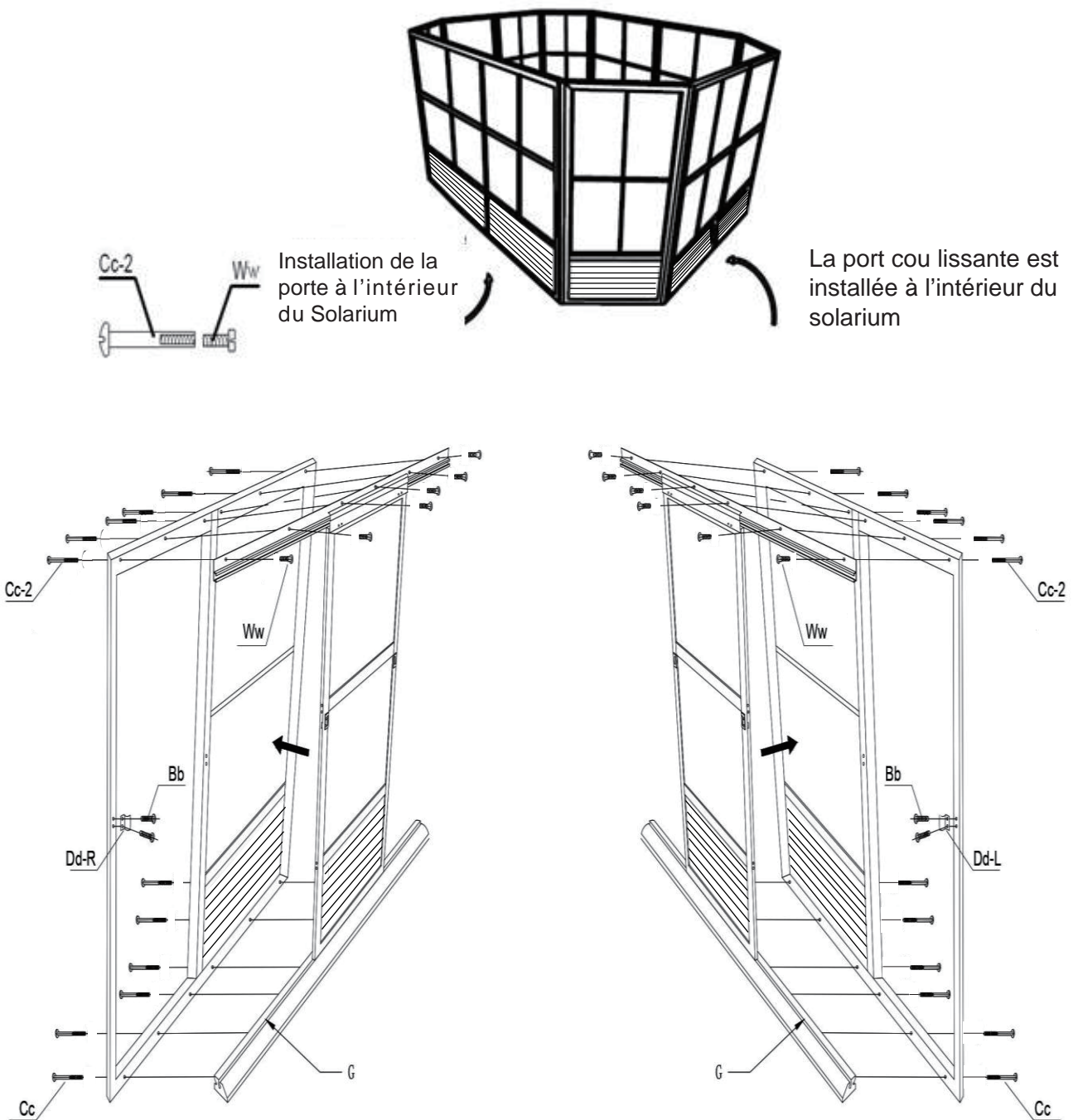

Étape 5:

1. Assembler l'angle en acier (Z2) aux supports de toit (L) à l'aide de boulons (Bb).
2. Attachez les chevrons de toit (L) au moyeu central (N) à l'aide des boulons (Bb).
3. Utilisez les vis (Z) pour fixer les chevrons (L) sur le dessus des panneaux passant par la pièce de métal (Z2) attachée au chevron (L).

Note: Ne serrez pas les boulons tout de suite car vous devrez peut-être ajuster l'angle lors de l'insertion des panneaux de toit.

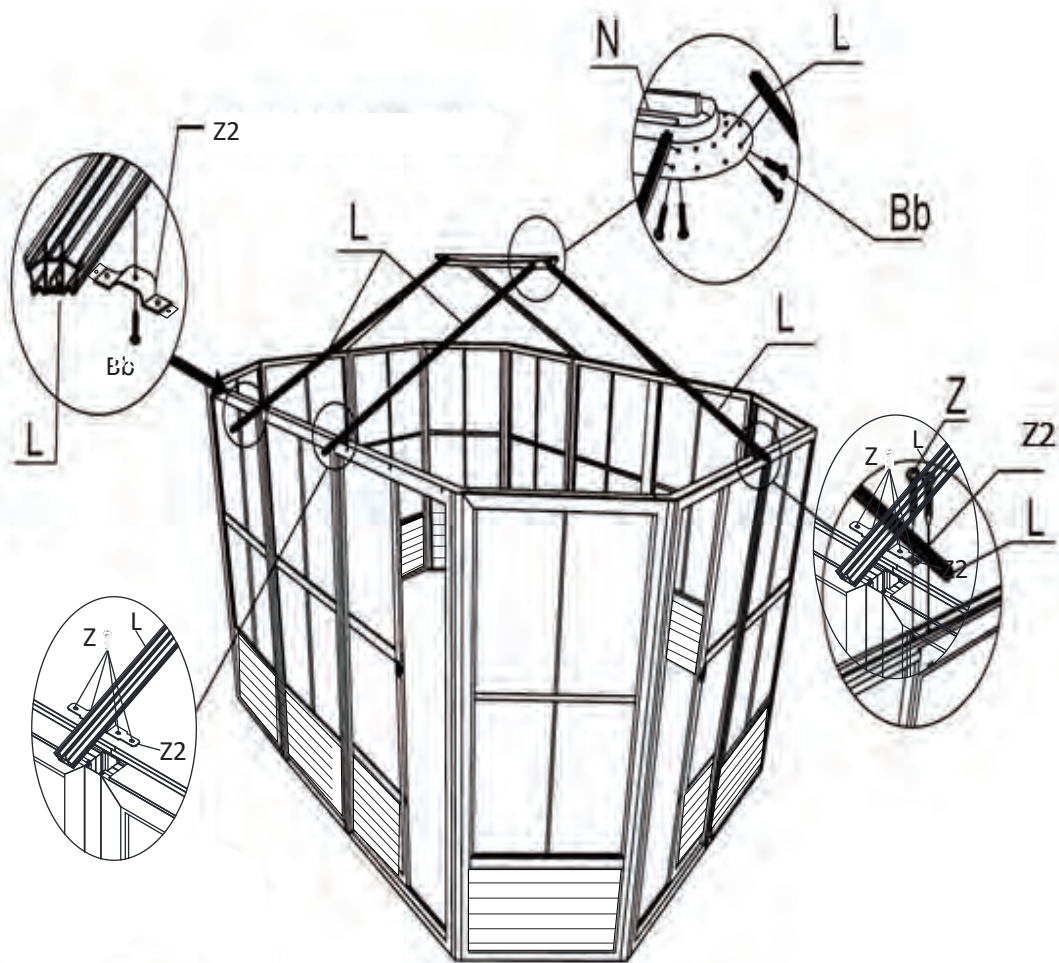

Étape 6:

1. Suivez la même procédure que celle du chevron (L) pour assembler les chevrons de toit (K) sur les panneaux restants.

Note:

1. Les chevrons doivent être attachés là où les panneaux se connectent les uns aux autres.
2. Attachez le chevron (K) de manière à ce que le trou supplémentaire sur le support (Z1) se fasse face comme illustré ci-dessous.
3. Ne serrez pas les boulons tout de suite car vous devrez peut-être ajuster l'angle lors de l'insertion des panneaux de toit.

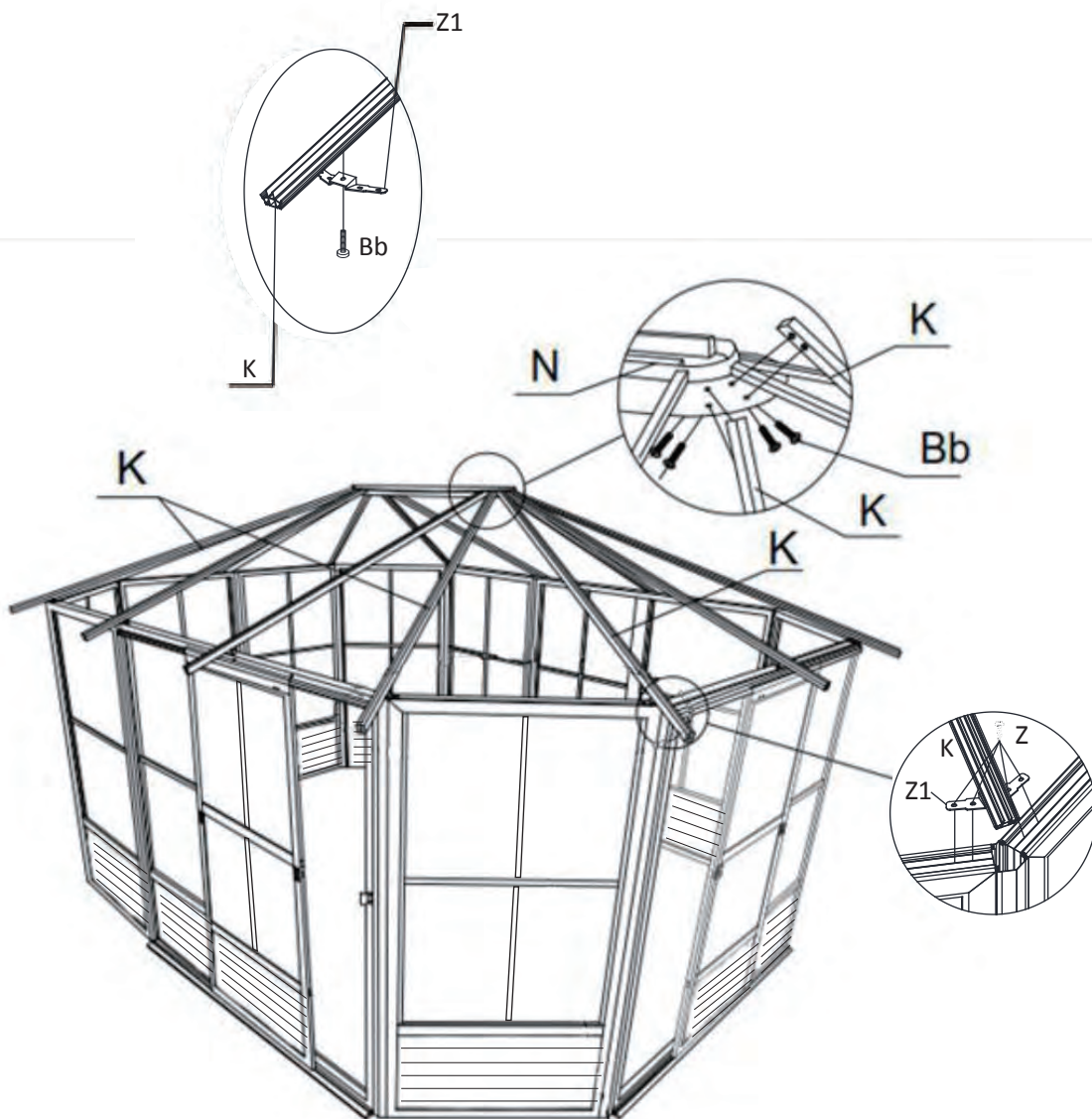

Étape 7:

1. Attachez les côtés du toit avec la barre de finition (S, U, Ss et U1) avec les boulons (Bb) et les supports R.
2. Connectez les barres de finition du toit (S, U, Ss et U1) les unes aux autres en alignant les trous. Placez les capuchons d'extrémité (R) sous les trous alignés et fixez-les avec des boulons (Bb).
3. Répétez le processus avec les barres de finition restantes comme illustré.
4. Pour terminer l'installation de la dernière barre de finition (S, U, Ss et U1), vous devez dévisser les premiers boulons (Bb) à votre point de départ et placer un capuchon d'extrémité (R), puis réinstaller les boulons (Bb).

NOTE : Assurez-vous que toutes les vis/boulons sont serrés une fois l'assemblage terminé.

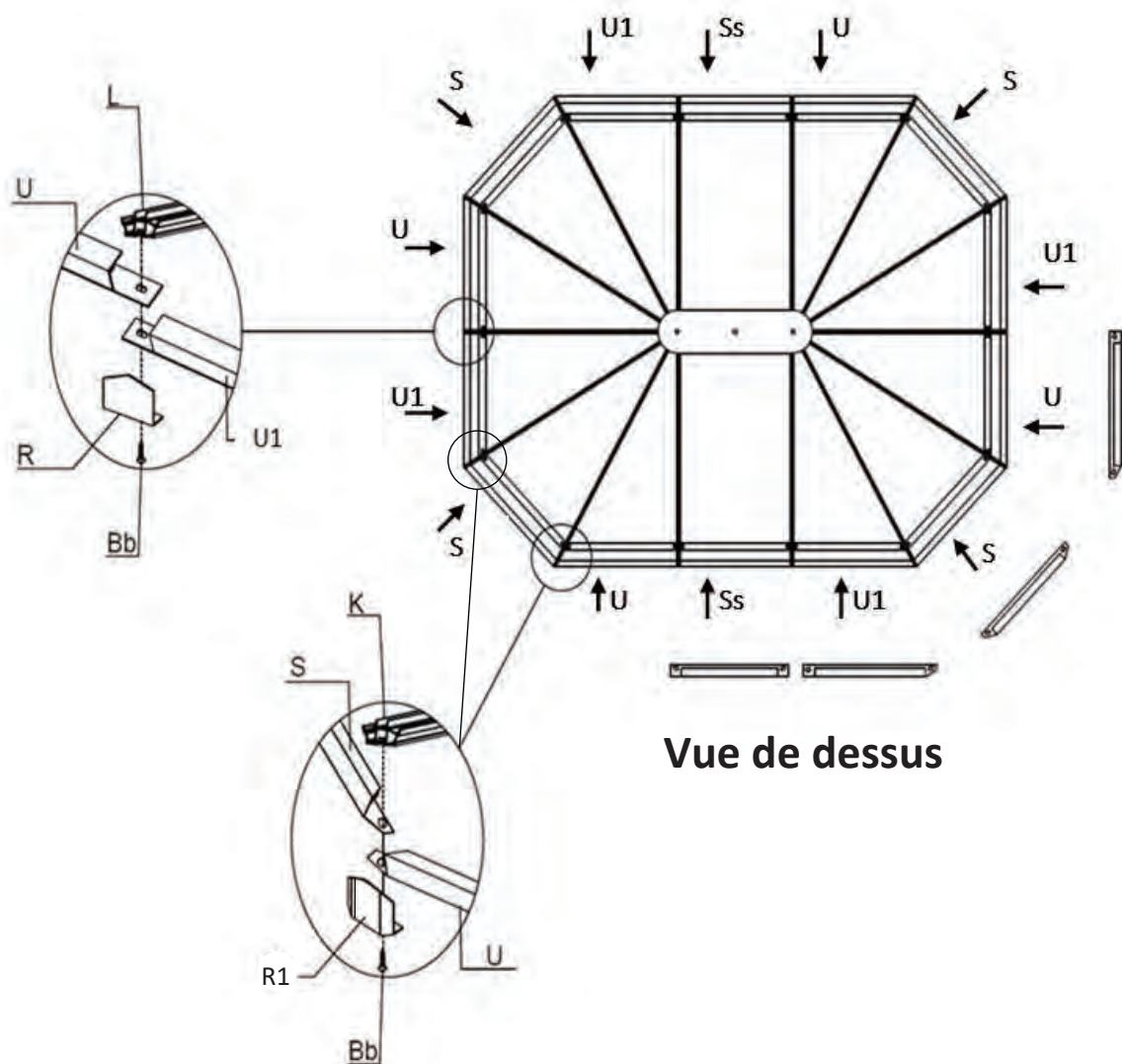

Étape 8:

1. De l'intérieur du solarium, installez tous les supports (Pp) à l'aide des boulons (Bb) sur les chevrons L.
2. De l'intérieur du solarium, installez tous les supports (Pp-1) à l'aide des boulons (Bb) sur les chevrons K.
3. De l'intérieur du solarium, installez la barre de solidification (T, Tt, V et V1) comme illustré à l'aide des boulons (Bb).

NOTE : Assurez-vous que toutes les vis / boulons sont serrés. Évitez de les serrer trop fort car cela peut endommager le filetage et la tête.

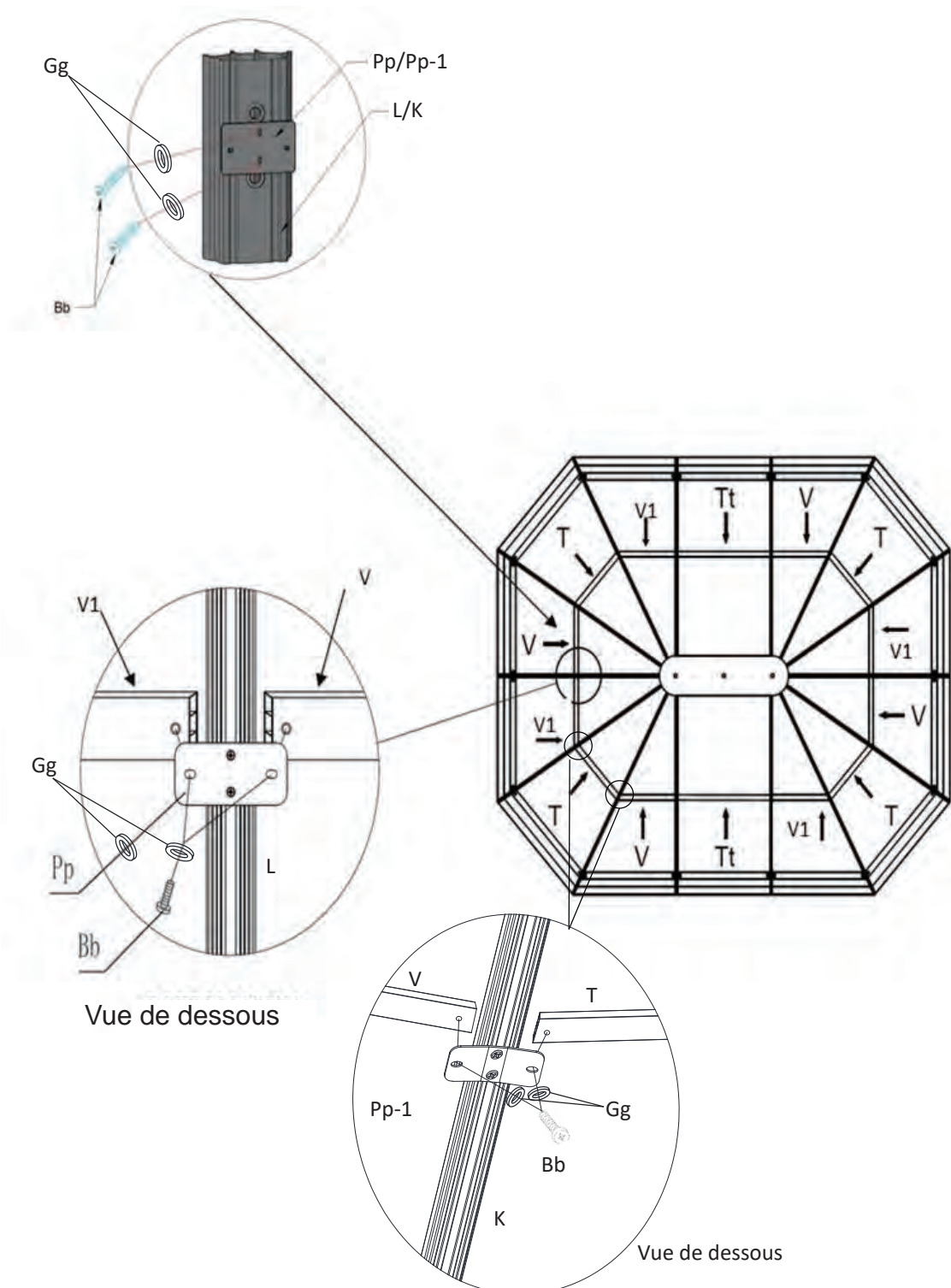

Étape 9:

1. Installez les panneaux de toit inférieurs (Jj, Kk Mm et Rr) en les faisant glisser dans la barre de finition (S, U, Ss & U1).

NOTE:

1. Veuillez vous référer aux autocollants pour savoir comment placer les panneaux de toit.
2. Assurez-vous que toutes les vis / boulons sont serrés.

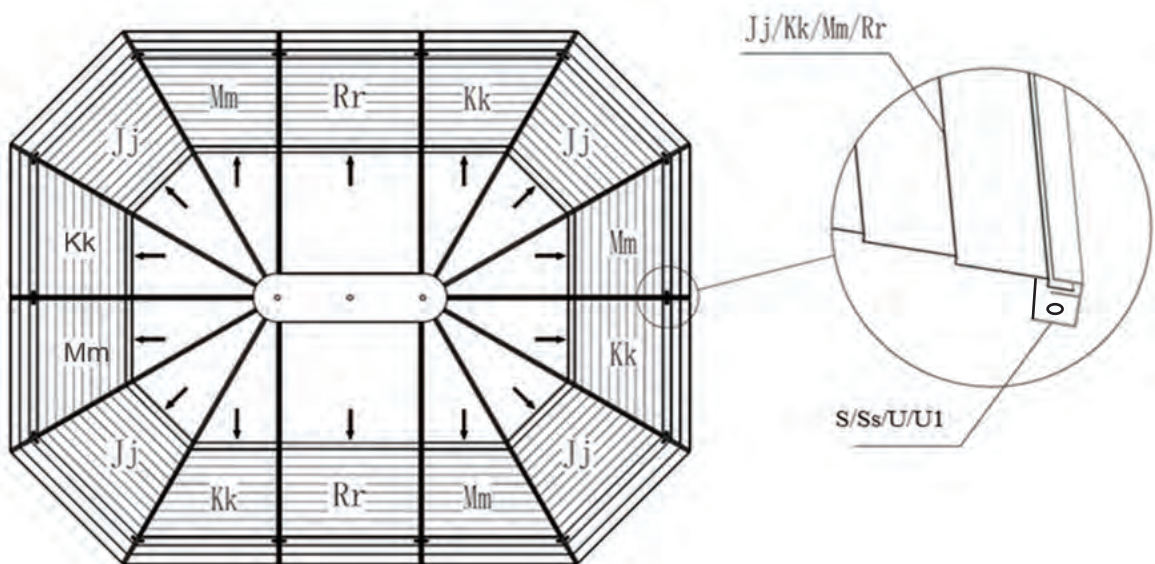

Vue de dessus

Étape 10:

1. Installez le panneau de toit supérieur (Aa) en le faisant glisser sur les chevrons de toit (K).

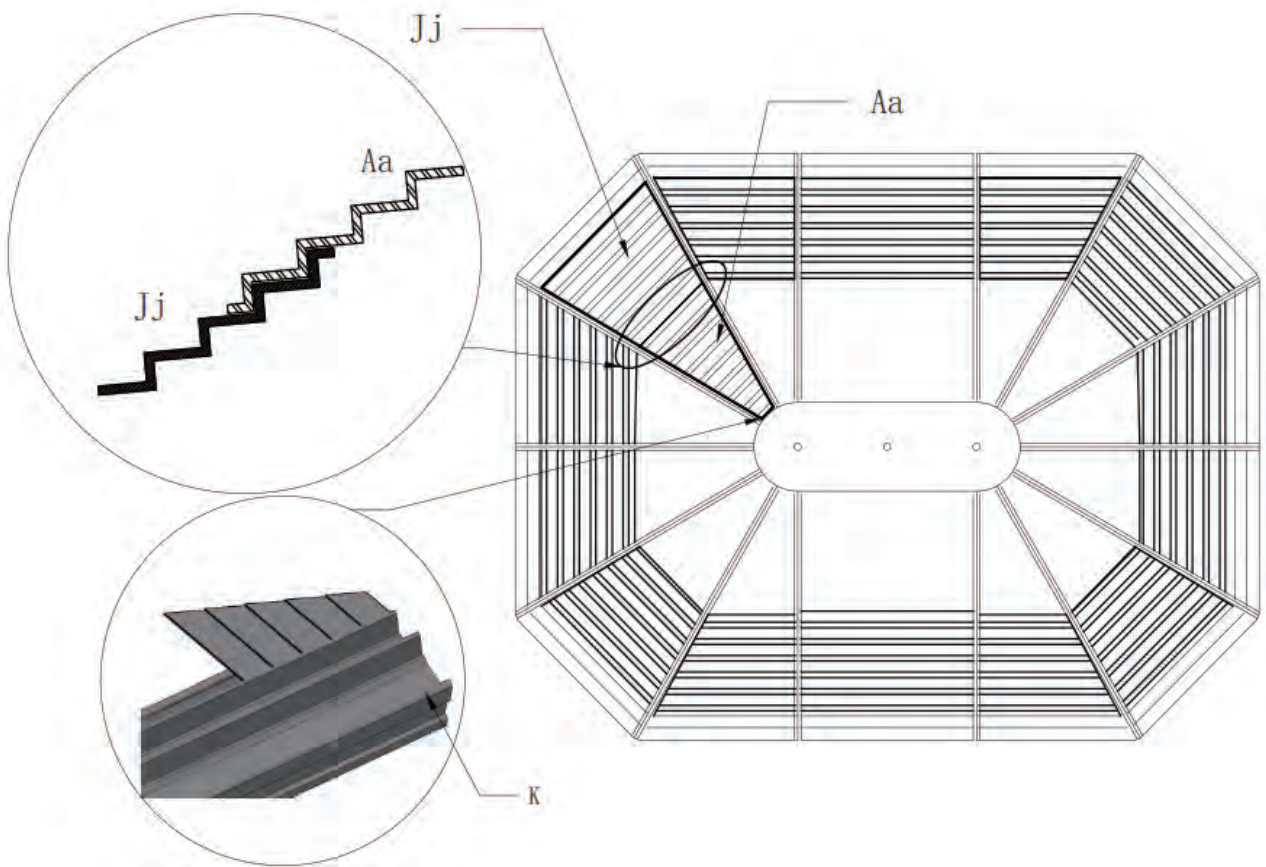

Étape 11:

1. Une fois l'installation du panneau de toit (Aa) terminée, sécurisez-le sur le chevron d'un côté de votre choix à l'aide du couvercle de chevron (0) et des vis (Oo1), puis placez un autre panneau de toit et répétez cette étape.

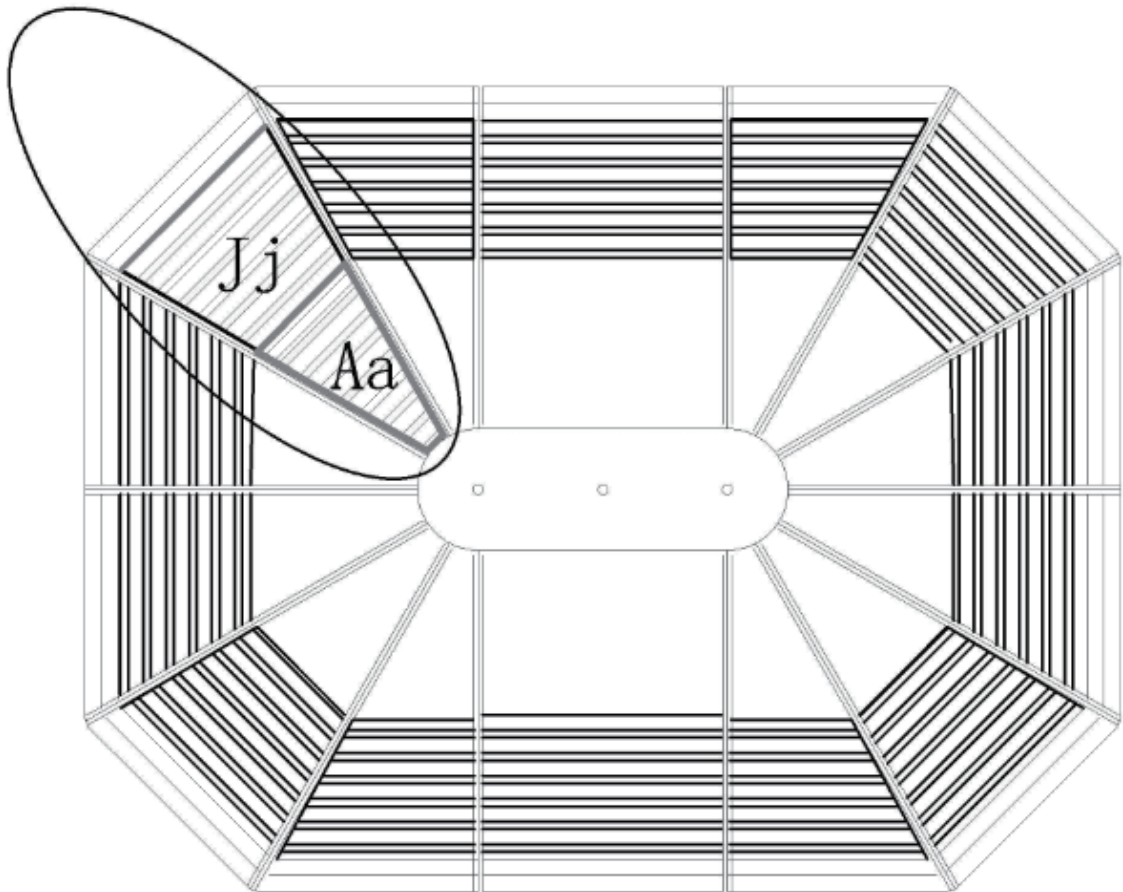
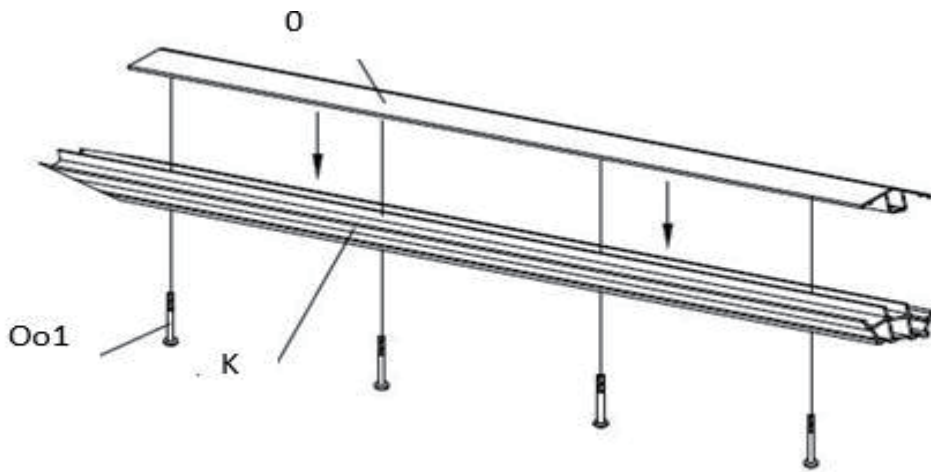

Étape 12:

1. Installez les panneaux de toit supérieurs (Aa, Ll, Qq, Y) en les glissant sur le dessus des chevrons de toit (K, L) à l'exception d'un panneau de toit (Qq), sécurisez-les à l'aide des couvertures de chevrons (0 et 01).

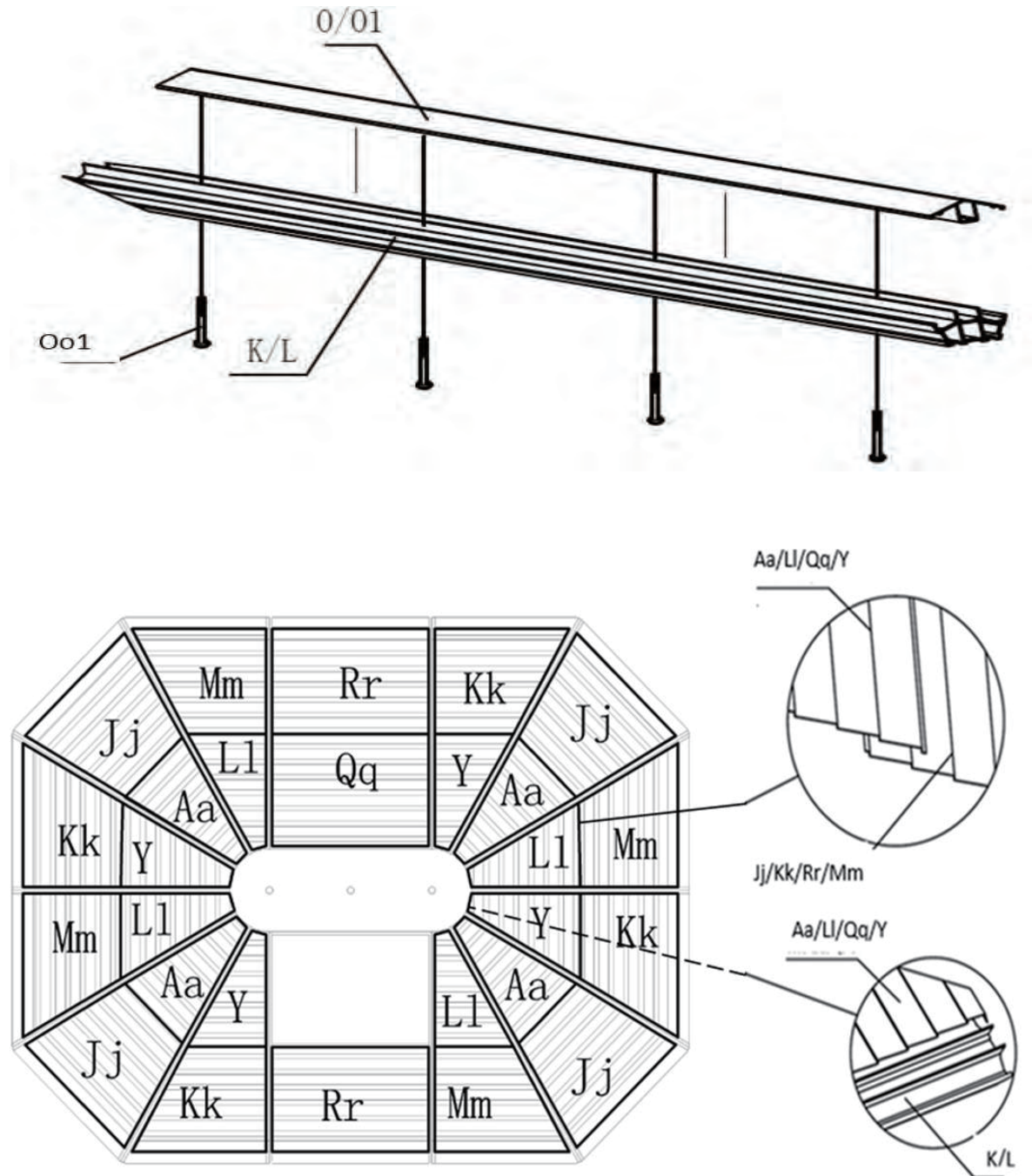

Vue de dessus

Étape 13:

1. Utilisez l'écrou (Hh) et la rondelle (Gg) pour attacher le capuchon supérieur (M) sur le moyeu central (N).

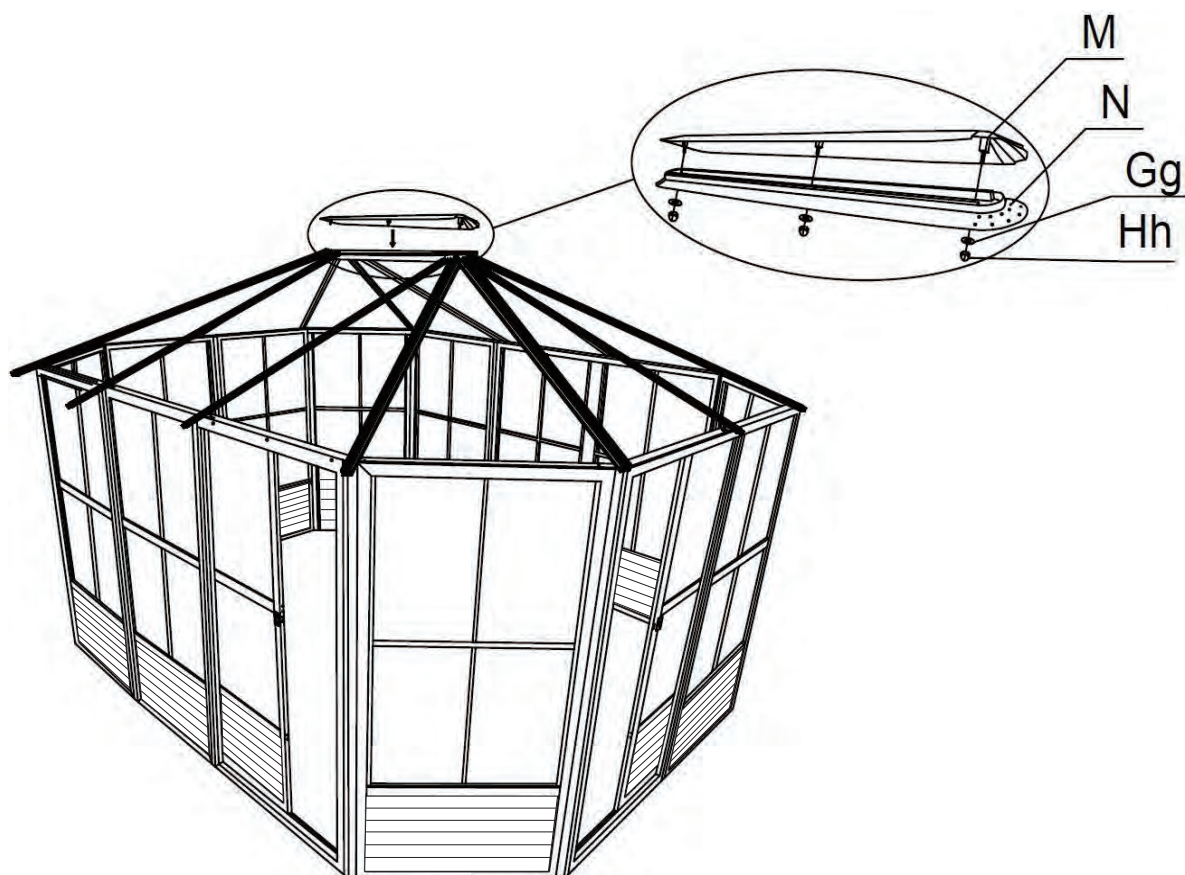

Étape 14:

1. Installez le dernier panneau de toit supérieur (Qq).

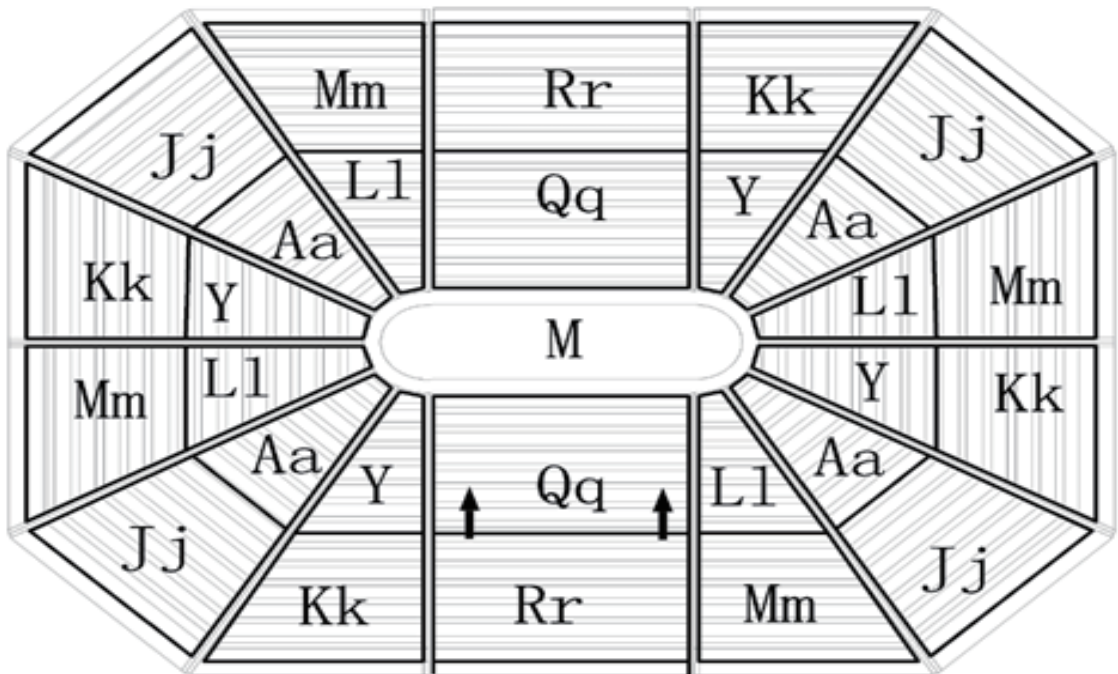

Vue de dessus

Étape 15:

1. Une fois le dernier panneau de toit installé, attachez la couverture de chevron (O1) à chevron (L) avec le boulon (Oo1).

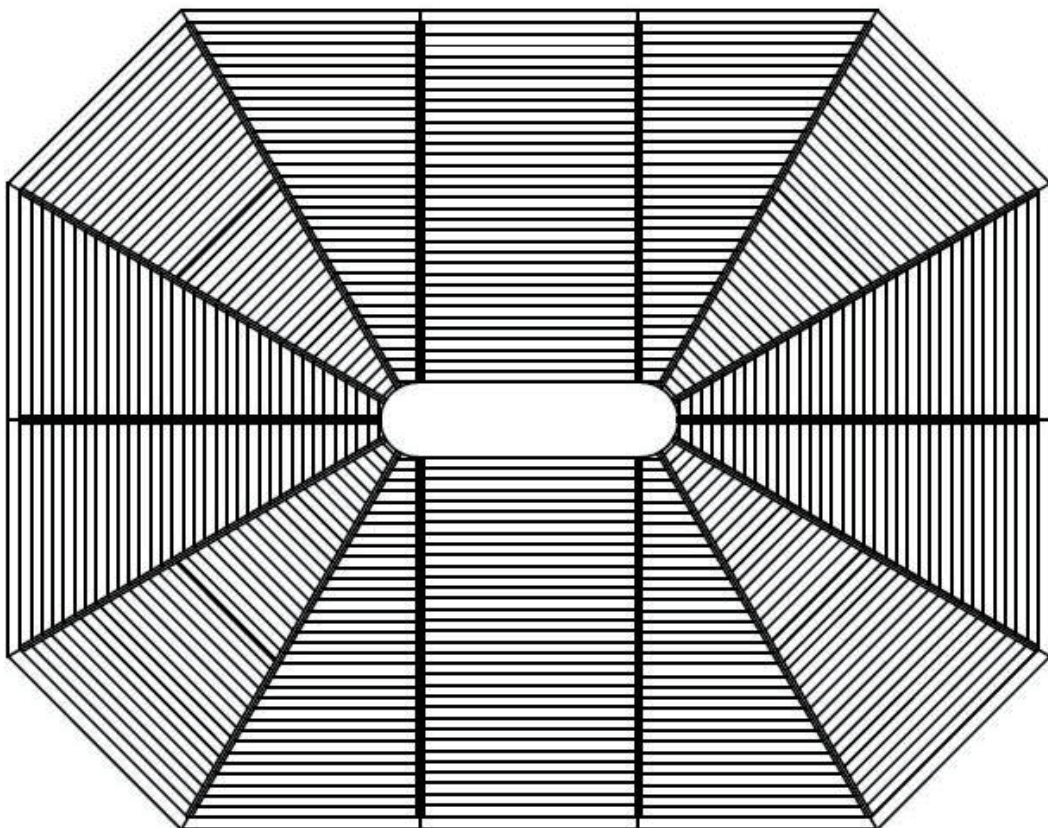
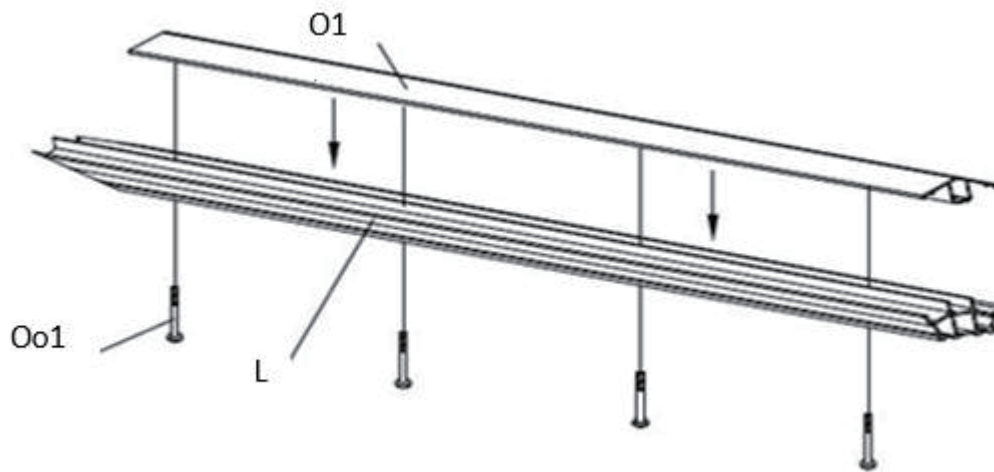

Étape 16:

1. À l'intérieur de chacun des panneaux du cadre, poussez deux bouchons en plastique (Ii) dans le sol et sécurisez l'unité en utilisant deux vis (Ee) pour chaque panneau ou utilisez tout autre type d'ancrage adapté au sol que vous utilisez.

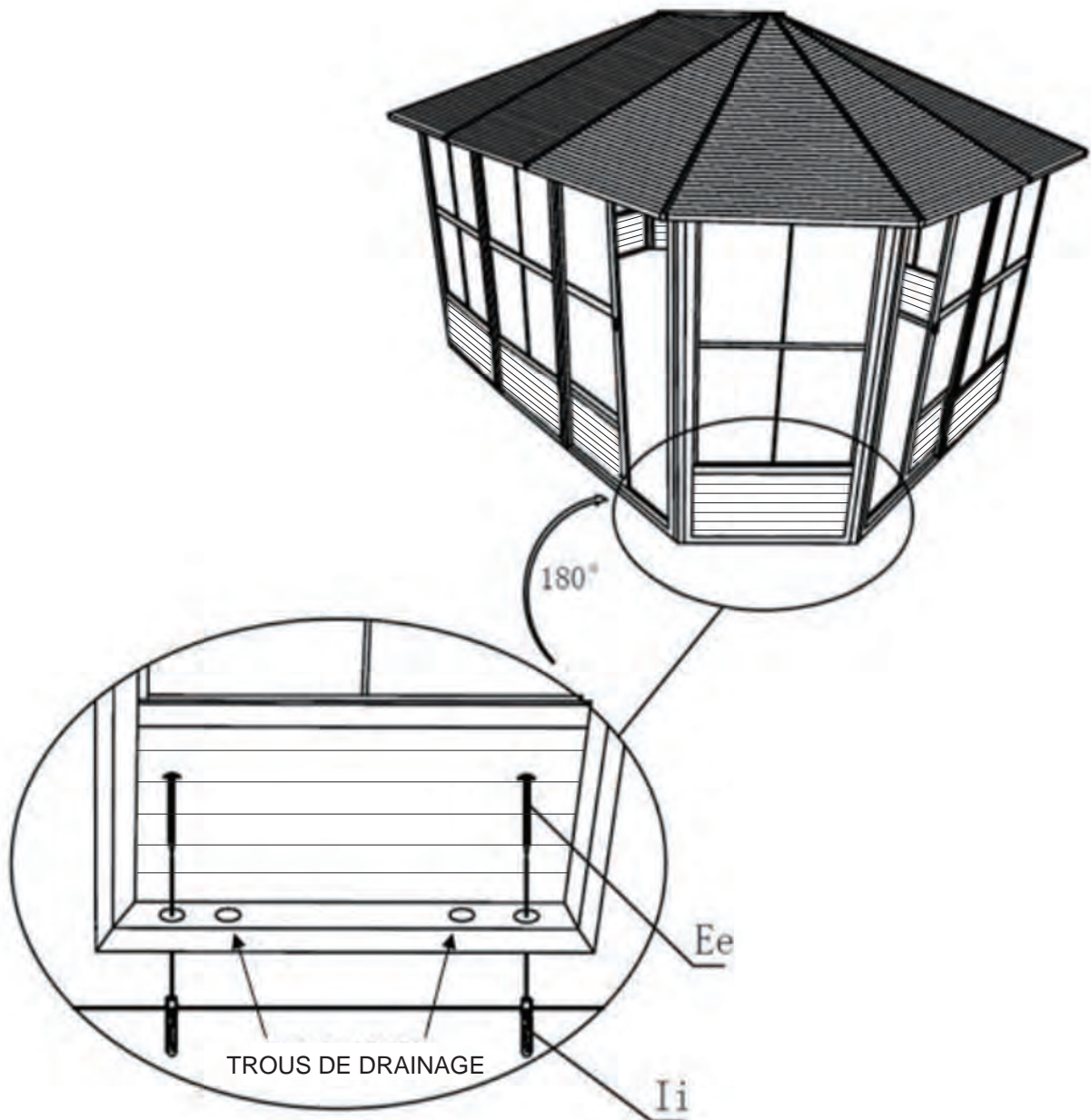

***Suggestions**

Les éléments mentionnés ci-dessous ne sont que des suggestions afin de permettre le drainage, elles varieront en fonction de votre revêtement de sol - matériel, platitude e pente.

Pour sol en Béton

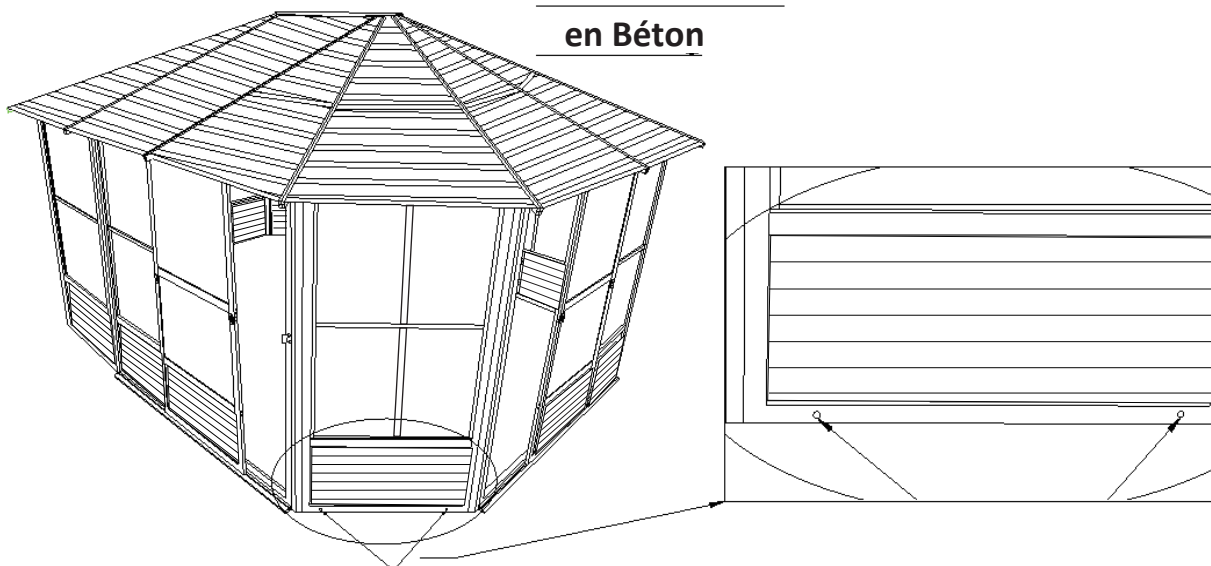

Sur la face extérieure, il est suggéré de percer de trous à l'extrémité inférieure des panneaux pour permettre le drainage

Pour Deck en bois

Forez les ponts où se trouvent les trous de drainage pour permettre de l'eau passer à travers.

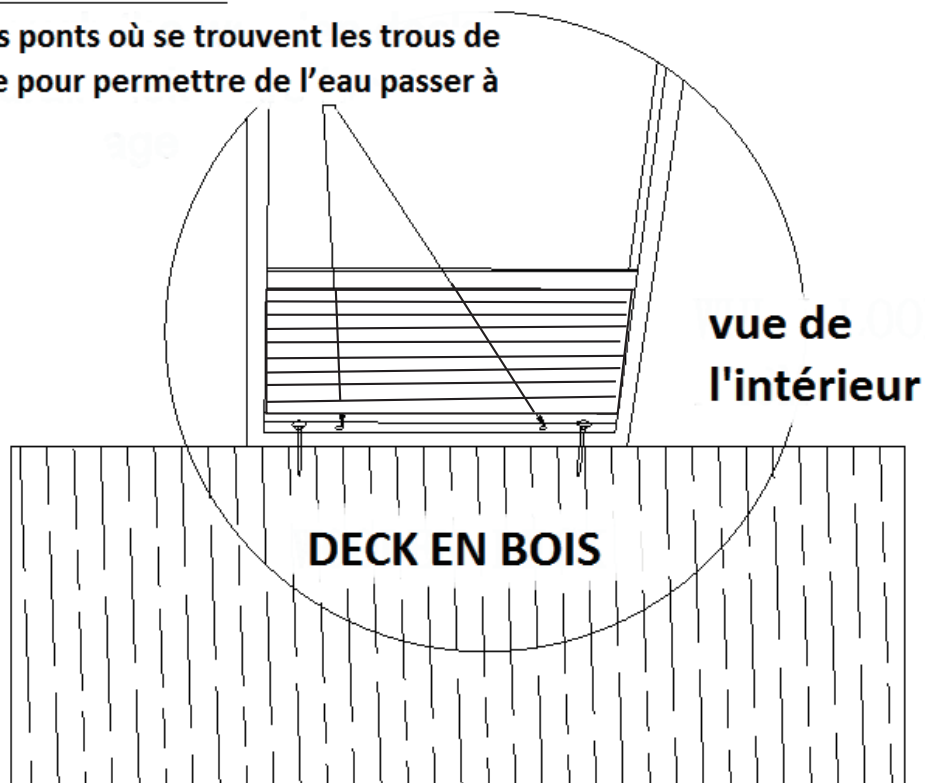

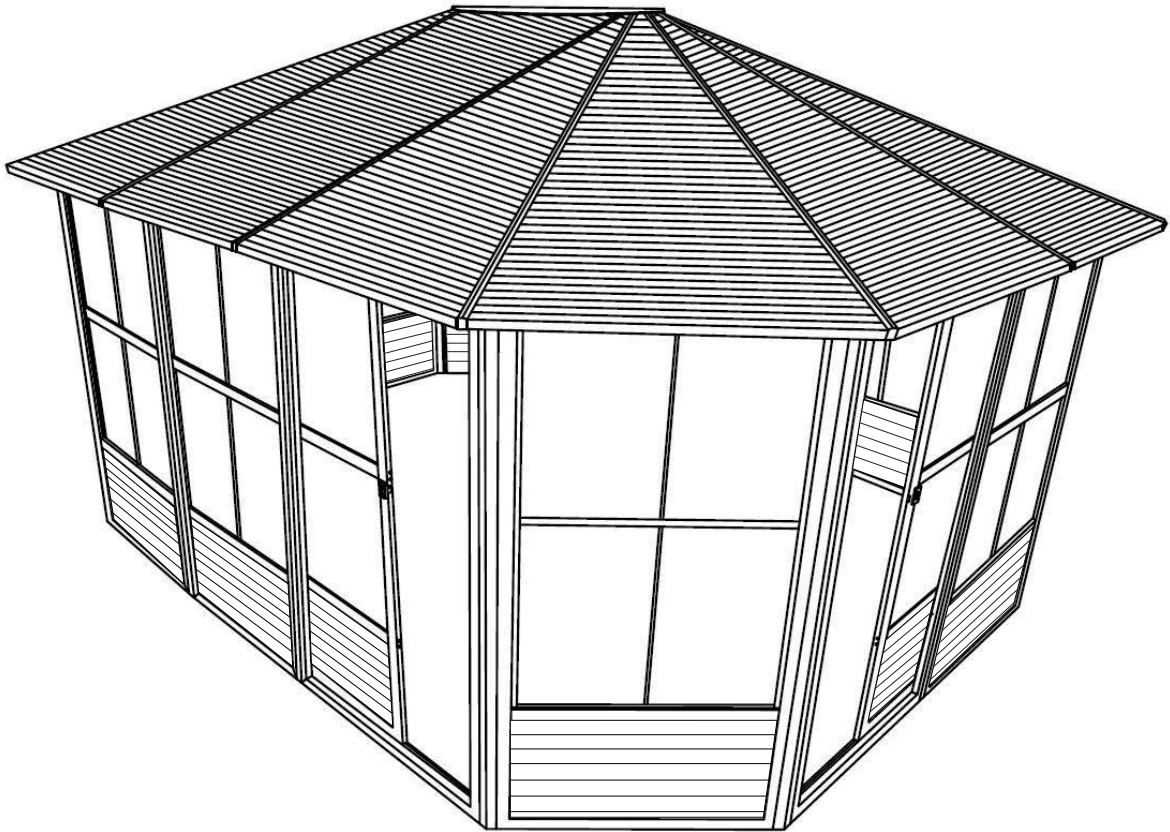
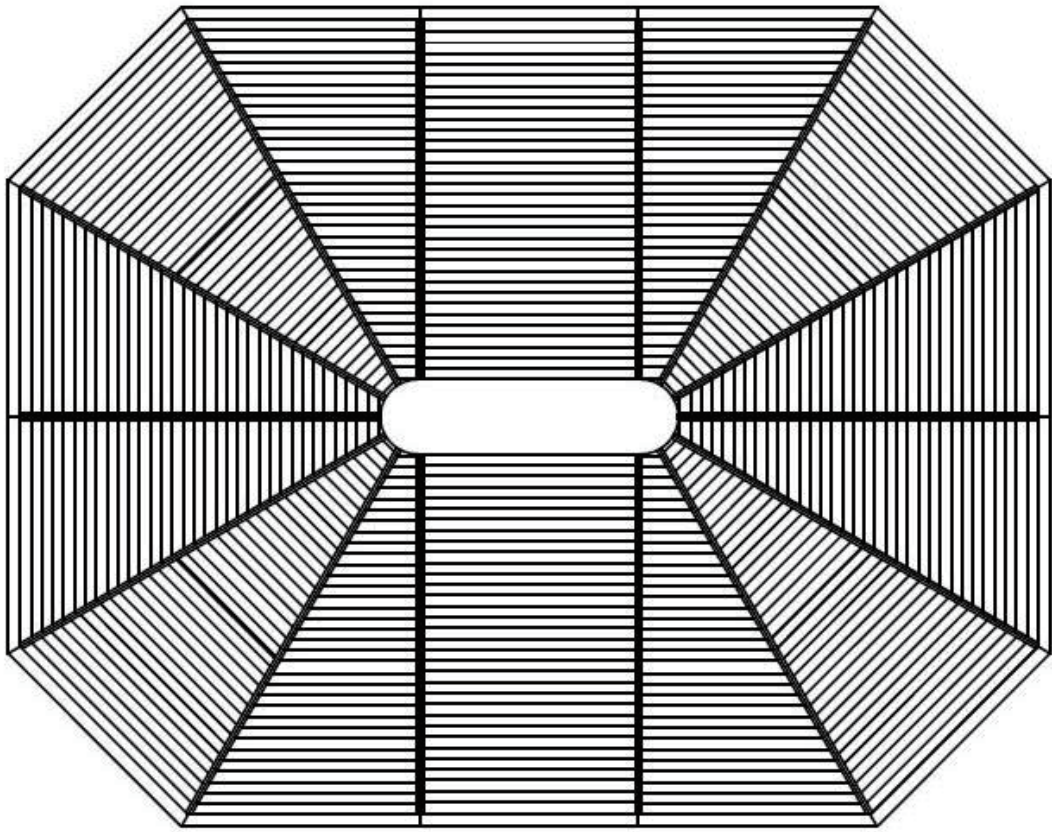

NOTE: LES DIMENSIONS SONT APPROXIMATIVES.

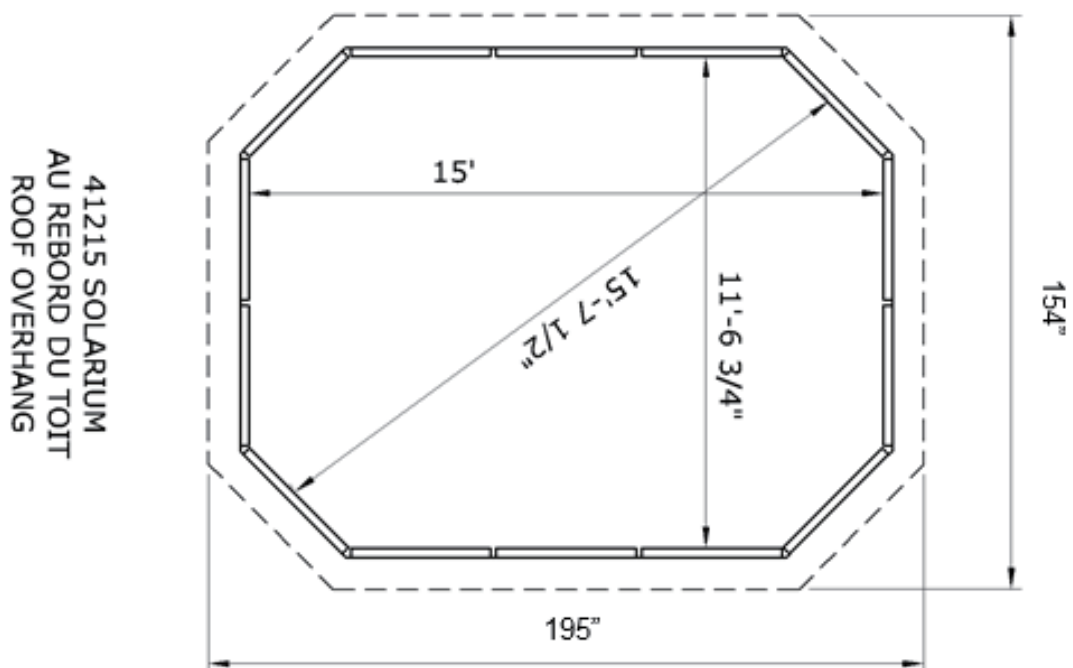
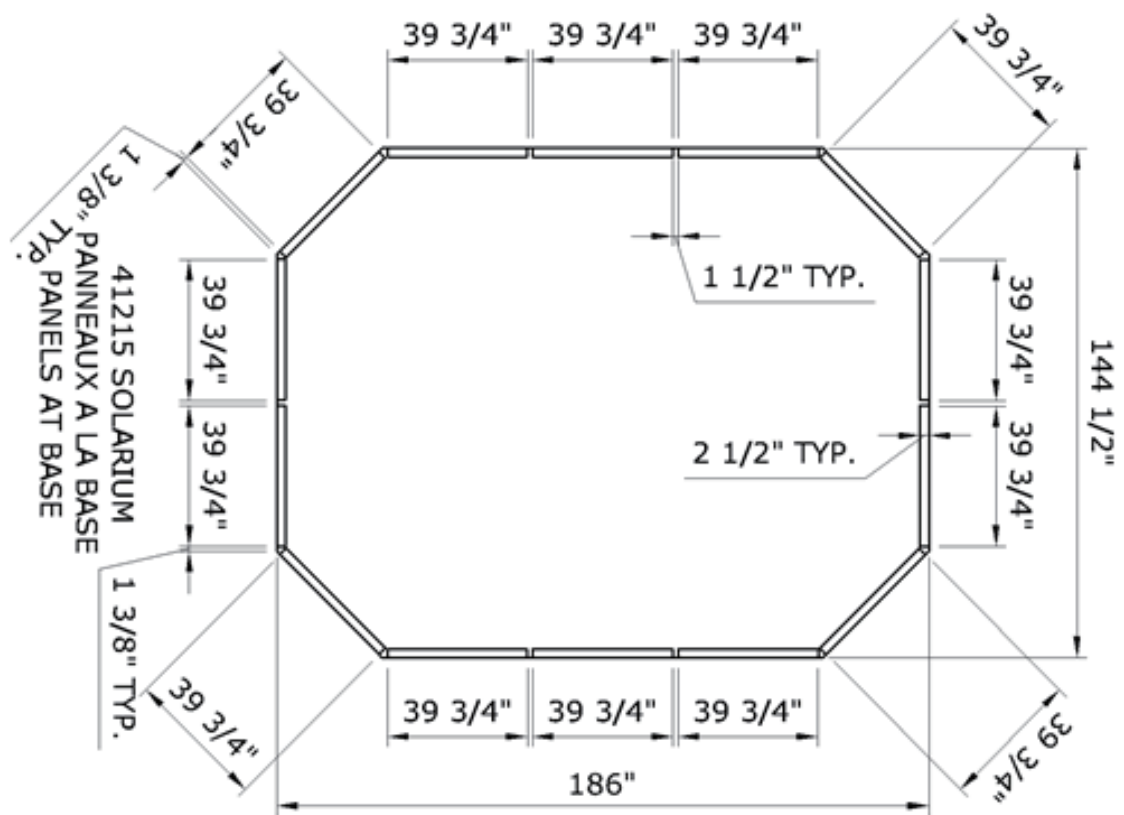

GARANTIE

Inspectez soigneusement le contenu de l'emballage afin de vérifier si certaines composantes sont manquantes ou endommagées. Advenant que certaines pièces soient manquantes ou endommagées, **ne retournez pas le produit à l'endroit où vous l'avez acheté**; contactez plutôt le département d'expérience client de Gazebo Penguin

Montréal : (514) 276-5643
Ailleurs au Canada et États-Unis : 1-800-737-7174
info@gazebopenguin.com

Ce produit a été conçu et fabriqué afin de répondre aux normes les plus exigeantes en matière de qualité et de durabilité. Sous réserve des sections « conditions d'application de la garantie » et des « limitations à la garantie » ci-dessous, il est garanti contre les défauts matériels ou de fabrication :

- **1 AN SUR LES DÉFAUTS MANUFACTURIERS**

Advenant que le produit soit endommagé ou que la période de garantie soit expirée, veuillez contacter le département d'expérience client de Gazebo Penguin afin d'obtenir une liste complète des pièces de remplacement et des prix.

LIMITATIONS ET EXCLUSIONS À LA GARANTIE

1. Ce produit n'est pas garanti contre les dommages causés par le vent, la chute d'objets, le feu, les animaux, la végétation, le vandalisme et les conditions climatiques extrêmes
2. Les effondrements d'abris causés par une accumulation de neige, de glace et de vents
3. Le toit doit être **maintenu libre en tout temps d'accumulation de neige et de glace**.
4. Tous les dommages pouvant être causés par des accumulations de neige et de glace ne sont pas couverts par la garantie. La neige et la glace doivent être enlevées du toit, de la droite vers la gauche, par sections de cinq pieds (5) à la fois.
5. L'enlèvement de la neige et de la glace du produit fait par l'intérieur peut endommager ledit produit et de plus causer possiblement des blessures graves à la (aux) personnes(s) impliquée(s) à l'enlèvement question.
6. Il est fortement recommandé que le produit ne soit pas placé de manière adjacente à un immeuble ou des arbres, car la neige ou la glace peut glisser sur le toit. Advenant que le produit soit placé de manière adjacente à un immeuble ou un arbre, des précautions supplémentaires doivent être prises afin de s'assurer qu'il n'y a aucune accumulation de neige ou de glace pouvant causer un poids excessif au produit.
7. Le produit ne sera garanti que s'il est installé conformément aux instructions écrites de Gazebo Penguin incluses avec le produit.
8. Des fuites dues à de fortes pluies peuvent survenir. Veuillez-vous référer au manuel d'instructions pour les positions des fenêtres et des informations sur la façon d'évacuer l'eau.
9. Le produit n'est pas garanti s'il a été ancré incorrectement.
10. Nous nous réservons le droit de remplacer ou réparer tout produit ou pièce défectueuse à notre seule discrétion.
11. Aucune modification ou ajout au produit n'est autorisée. Cela annulera votre garantie.



MANUEL D'INSTRUCTIONS INSTRUCTION MANUAL

FLORENCE - 12 x 15 TOIT D'ACIER
FLENCE-12x15 METAL ROOF

sku: 41215MR-GP-12		
sku: 41215MR-GP-32		

**DO NOT DESTROY THE BOXES UNTIL COMPLETELY ASSEMBLED
FOR FUTURE REFERENCE,
TAKE PICTURES OF ALL SIX SIDES OF EACH OF THE BOXES UPON RECEIPT.
PLEASE VERIFY THE CONTENT OF EACH BOX AGAINST THE LIST OF PARTS**

12ft x 15ft / 3.66m x 4.57m Meters Solarium

Instruction Manual

IMPORTANT: RETAIN FOR FUTURE REFERENCE, READ CAREFULLY

Consult with your local governing authority / local municipal codes regarding installation of temporary structures before purchase or assembly. Some jurisdictions may require permits for, or otherwise regulate, installation and use.

For assistance with assembly, installation, parts, or customer service, contact Gazebo Penguin Customer Service Department at the numbers listed below (English & French, Mon-Fri 8:00 AM to 4:00 PM EST):

Montreal: (514) 276-3485

Elsewhere in Canada and the US: 1-800-737-7174

WARNING:

- For outdoor use.
- Snow should be regularly cleared from the roof and not allowed to accumulate.
- Retain your **proof of purchase** for warranty purposes. Also keep the **original boxes** until the installation is complete and correct.
- The unit may take more than 4 hours and 3 people are required for this assembly.



PRIOR TO ASSEMBLY:

- Please don't destroy boxes until completely assembled.
- The foundation must be level, flat, and solid, such as concrete or asphalt.
- Keep away from overhead utility lines, tree branches, and other structures.
- Check for underground pipes or wires if digging or drilling is required.
- Do not install near roof lines or other structures that could shed snow, ice, or excessive rain run-off onto the roof top.
- Assemble the structure as close to its final location as possible.
- It is recommended to wear safety gloves, safety glasses, and hard hats for installation.
- Do not hang from, climb on, or stand on the structure or roof.
- Before assembly, read instructions and check that all parts are present in the boxes. If any parts are missing, refer to warranty information.
- A 6ft (1.8m) stepladder, Phillips screwdriver, tape measure, level, mallet, and a tarp to place parts on will be required for assembly (not included).
- Remove top protective film from roof panels prior to assembly; DO NOT remove bottom protective film until ready to insert roof panels, so as to identify which side is on top.

ANCHORING INSTRUCTIONS:

- Proper anchoring of the frame to the base and the wall is required for safety.
- Any structure not anchored securely has the potential to fly away during high wind causing damage and safety hazard.
- How the item is anchored, and the hardware and tools required, will vary based upon the set up location and are not provided.
- Please check with your local hardware store if for the appropriate anchors for your surface.
- Do not anchor to pavers / pavement slabs because they are not a solid foundation.
- Periodically check the anchors to ensure they remain secure

CARE AND MAINTENANCE:

- In case of a defective or damaged part, or for any other questions concerning the product, please contact the manufacturer directly.
- Please have the parts list and part numbers on hand when ordering or requesting replacement parts.









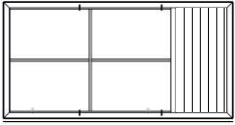
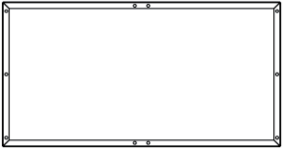

ROOF PANELS:

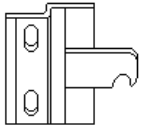
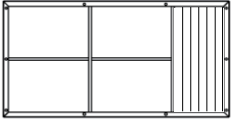
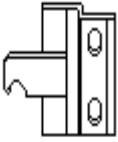
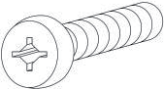
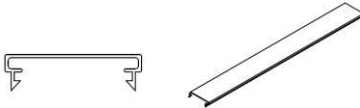
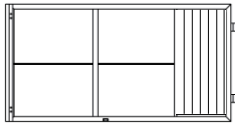
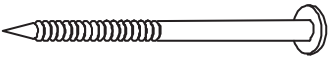

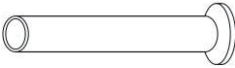

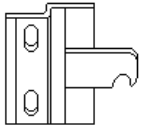
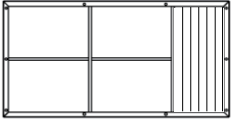
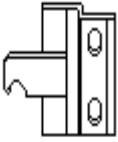
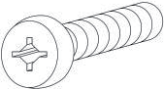
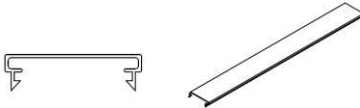
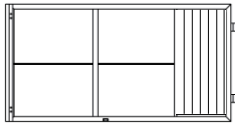
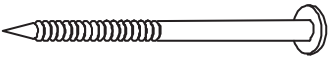

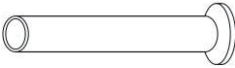



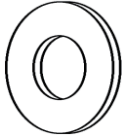

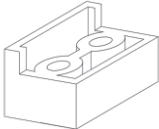
- Gently clean with an environmentally-friendly soap solution and water using a sponge or washcloth.
- Do not use abrasive materials, wire brushes, chemicals, harsh cleaners, or bleach.
- Rinse using a garden hose and air dry. If removed, ensure thoroughly dry prior to storage.
- Do not use pressure washer.

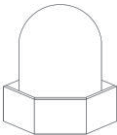
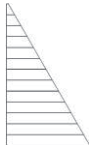



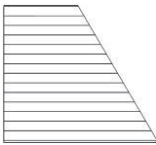

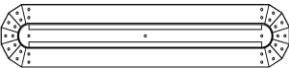
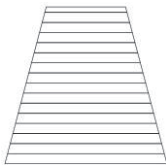
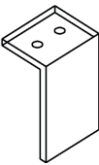



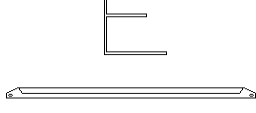

STRUCTURE:



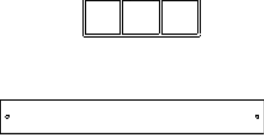
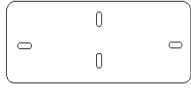

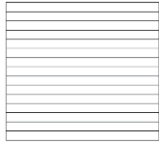
- Gently clean with an environmentally-friendly soap solution and water using a sponge or washcloth.
- Do not use abrasive materials, wire brushes, chemicals, harsh cleaners, or bleach.
- Rinse using a garden hose and air dry.
- Do not use pressure washer.
- If there are nicks, chips, and/or scratches see the part # of the paint in the parts list to obtain a matching touch-up paint.

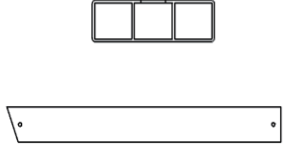
12 x 15 Solarium

DESCRIPTION	PACKED IN BOX	QTY	DRAWING	DESCRIPTION	PACKED IN BOX	QTY	DRAWING																																																
08-129-32 REGULAR FRAME A	3	5		08-132-32 SLIDING DOOR FRAME D	3	1																																																	
	4	5			4	1		17-054 ROOF PANEL Aa	1	4		08-165-32 DOOR LATCH Dd-R	5	2		08-130-32 FRAME NEXT TO DOORS (extra holes) B	3	1		08-169-32 DOOR LATCH Dd-L	5	2		4	1	08-158-32 SCREW M6*16 Bb	5	124		08-133-32 CONNECTING PIECE 78.9" E	5	12		08-131-32 SLIDING DOOR C	3	1		08-167-32 SCREW M6*63.5 Ee	5	24		4	1	08-161-32 SCREW M6*73 Cc	5	12		08-136-32 TOP DOOR RAIL 81.1" F	5	2		12-037-32 CAPNUT M5*60 Cc-2	5	12	
17-054 ROOF PANEL Aa	1	4		08-165-32 DOOR LATCH Dd-R	5	2																																																	
08-130-32 FRAME NEXT TO DOORS (extra holes) B	3	1		08-169-32 DOOR LATCH Dd-L	5	2																																																	
	4	1																																																					
08-158-32 SCREW M6*16 Bb	5	124		08-133-32 CONNECTING PIECE 78.9" E	5	12																																																	
08-131-32 SLIDING DOOR C	3	1		08-167-32 SCREW M6*63.5 Ee	5	24																																																	
	4	1																																																					
08-161-32 SCREW M6*73 Cc	5	12		08-136-32 TOP DOOR RAIL 81.1" F	5	2																																																	
12-037-32 CAPNUT M5*60 Cc-2	5	12		08-137-32 BOTTOM DOOR RAIL 81.1" G	5	2																																																	

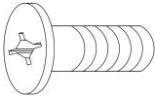
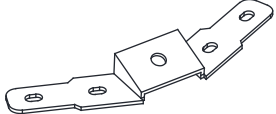
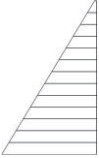
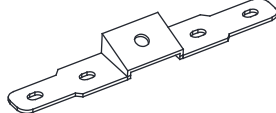
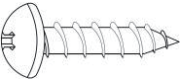
DESCRIPTION	PACKED IN BOX	QTY	DRAWING	DESCRIPTION	PACKED IN BOX	QTY	DRAWING
08-187-32 WASHER Gg	5	59		17-061 ROOF PANEL Kk	2	4	
08-138-32 DOOR STOPPER H	5	4		17-044-32 RAFTER 78.9" L	5	6	
08-189-32 ACORN NUT Hh	5	3		17-057 ROOF PANEL Li	2	4	
08-139-32 CONNECTING PIECE 78.9" I	5	8		08-179-32 TOP CAP M	5	1	
08-193 PLASTIC PLUG li	5	24		17-058 ROOF PANEL Mm	2	4	
08-140-32 CONNECTING PIECE 78.9" J	5	8		08-178-32 CENTRAL HUB N	5	1	
17-055 ROOF PANEL Jj	1	4		08-134-32 UPPER DOOR RAIL END CAP Nn	5	4	
17-043-32 RAFTER 89.9" K	5	8		17-049-32 COVER FOR RAFTER 88.9" O	5	8	

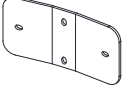
DESCRIPTION	PACKED IN BOX	QTY	DRAWING	DESCRIPTION	PACKED IN BOX	QTY	DRAWING
17-050-32 COVER FOR RAFTER 78.5" O1	5	6		17-046-32 FINISHING BAR 45.3" S	5	4	
08-135-32 SCREW Oo	5	4		17-068-32 FINISHING BAR 42.6" Ss	5	2	
16-118-32 SCREW M6 X 36 Oo1	5	56		17-048-32 SOLIDIFYING BAR 21.6" T	5	4	
17-051-32 GAP COVER BAR 39.7" P	5	10		17-069-32 SOLIDIFYING BAR 39.8" Tt	5	2	
18-067-32 SOLIDIFYING BAR BRACKET Pp	5	6		17-045-32 FINISHING BAR 45.2" U	5	4	
17-075 ROOF PANEL Qq	1	2		17-071-32 FINISHING BAR 45.2" U1	5	4	
17-053-32 END CAP R	5	6		17-047-32 SOLIDIFYING BAR 21.5" V	5	4	
17-076 ROOF PANEL Rr	1	2		17-070-32 SOLIDIFYING BAR 21.5" V1	5	4	

DESCRIPTION	PACKED IN BOX	QTY	DRAWING	DESCRIPTION	PACKED IN BOX	QTY	DRAWING
12-047-32 SCREW M5 X 15 Ww	5	12		15-124-32 BRACKET Z1	5	8	
17-060 ROOF PANEL Y	2	4		15-125-32 BRACKET Z2	5	6	
08-156-32 SCREW M5 X 20 Z	5	56		23-003 GAP COVER BAR 40.3" P-1	5	4	
23-004 SOLIDIFYING BAR BRACKET Pp-1	5	8		23-005 END CAP R1	5	8	

***NOT INCLUDED IN THE BOX**

DESCRIPTION	COLOUR	PART #
SPRAY PAINT	SLATE	18-125
PAINT PEN		18-126

Before you assemble the Solarium

- Please don't destroy boxes until completely assembled.
- For future reference, take pictures of all six sides of each of the boxes upon receipt.
- Please verify the content of each box against the list of parts.

Tools needed:

- Step Ladder 6' – 8'
- #2 Phillips Screwdriver, Robertson #2 (not supplied)
- Rubber Mallet
- Various Files
- Drill Machine
Drill bit 1/8" for Pilot holes

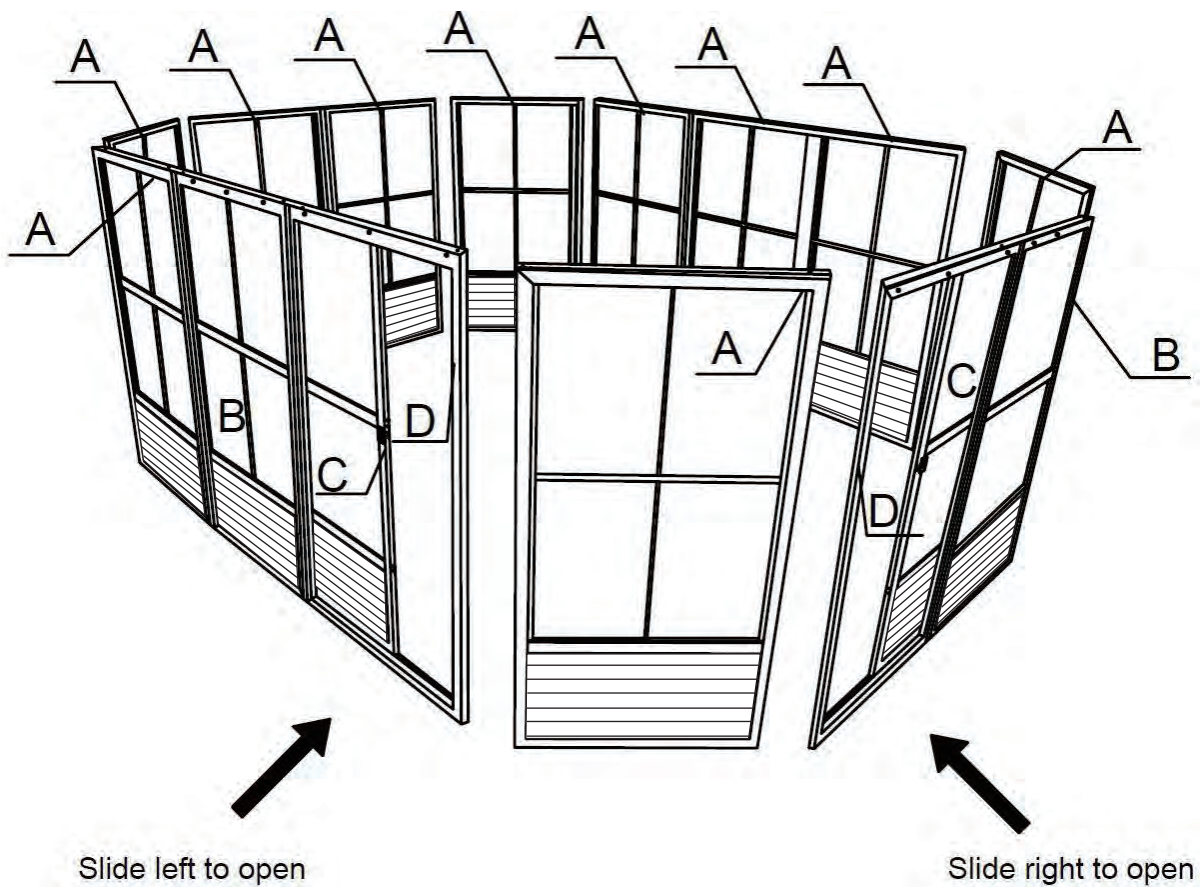

Based on the location, decide where you would like to position the two (2) doors panels which can slide open to the left or the right, your choice.

Step 1:

Before starting to assemble, please decide where you would like to position the door panels.

1. Stand up two Regular Frames (A) and affix the panels together at an angle by sliding two connecting Pieces (I, J) from top to bottom.
2. Next stand up the Frame Next To Door (B) and using Connecting Piece (E) connect it to previously set Door Frame A, as shown below. Similarly set up a Door Frame (D) by placing the door frame either on the left or right, using the Connecting Piece (E).
3. When assembling angled Regular Panels (A), you should put the two panels at 135 degree angle then use the angled Connecting Pieces (I) and (J) slide from top to bottom to affix the panels together.
4. Frame screening should be facing the outside of the unit.
5. Door frame step down is on the inside of the unit.

Note: When sliding the part I, J and E into the frames shake the frames for it too slide. Do not apply excess force. Make sure the edges are clean from any extra paint if necessary use a fine file.

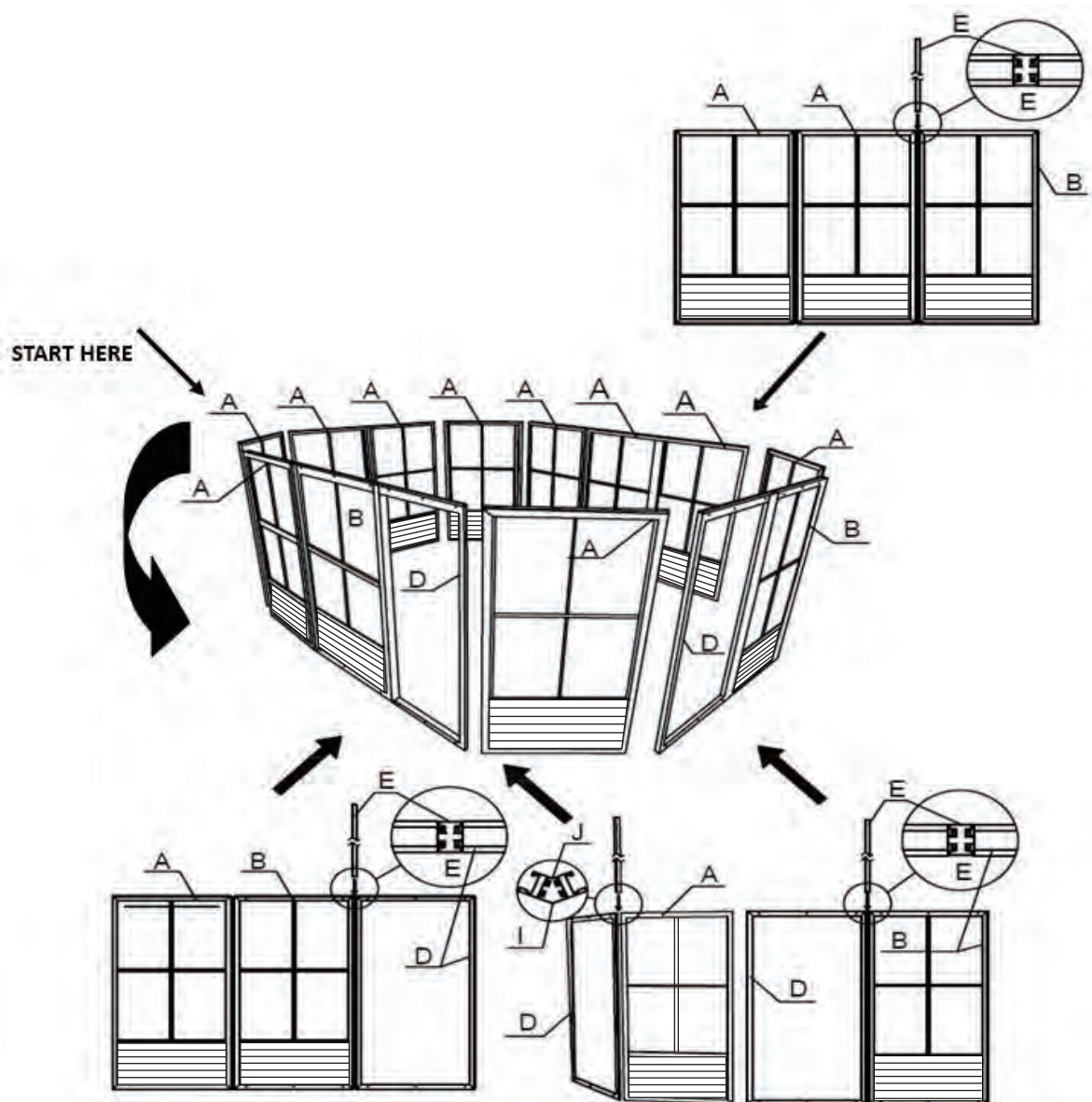

Step 2:

1. Affix gap Cover Bars (P/P-1) by sliding them on the top of the exterior groove of the Regular Frames (A, B, D).

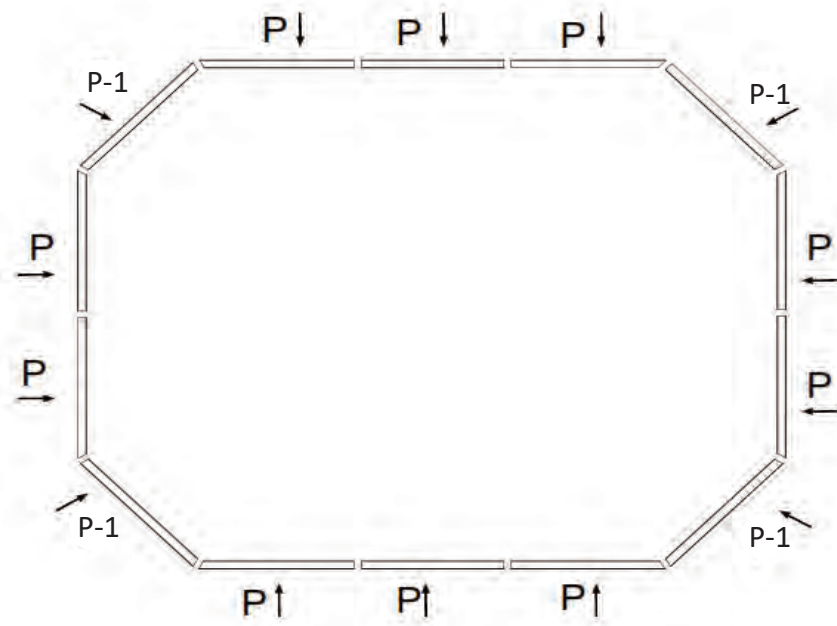
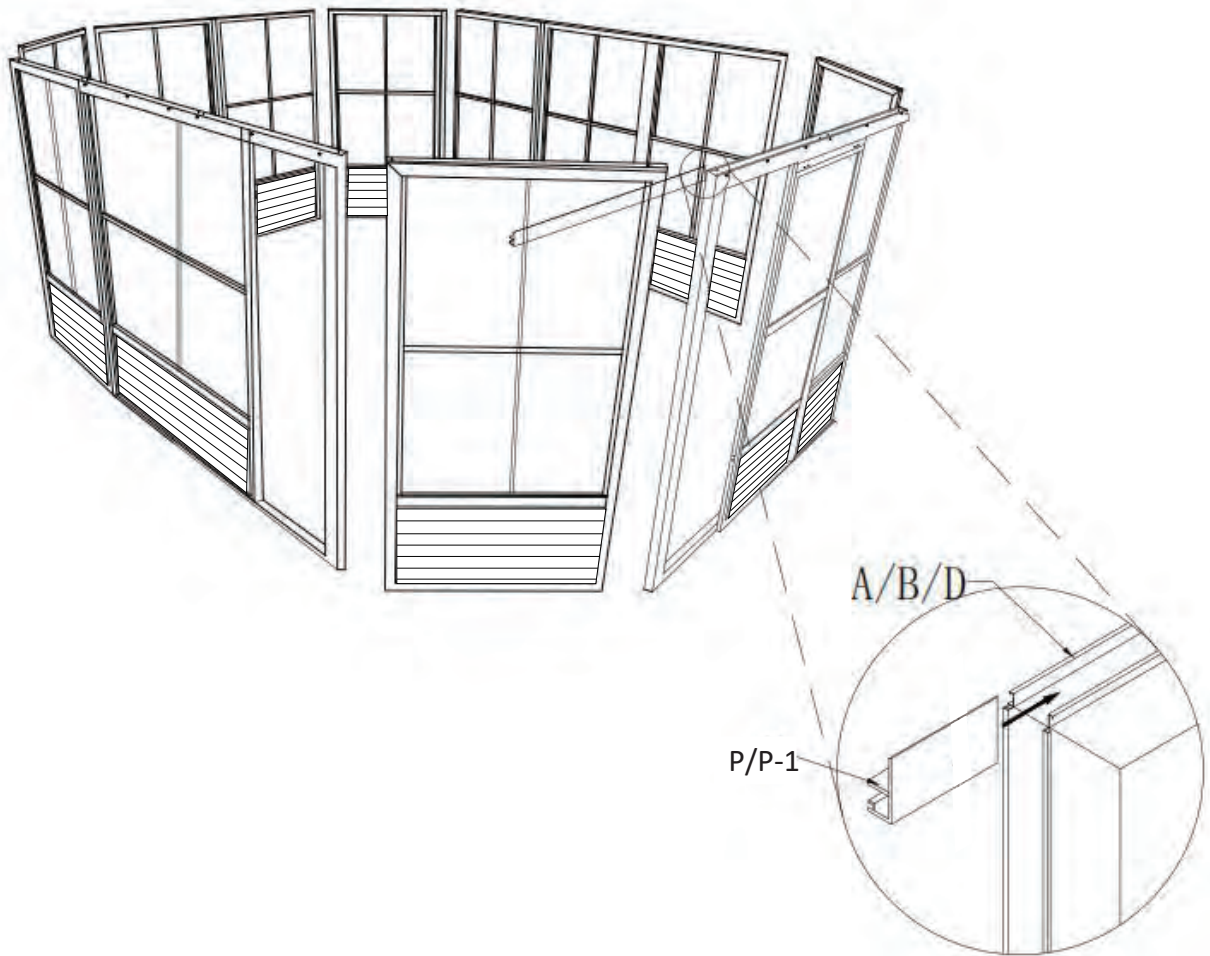

Step 3:

1. Slide Top Door Rail (F) into wheels of Sliding Door (C).
2. Slide Lower Door Rail (G) into the plastic guide of the Sliding Door (C).
3. Use Bolts (Bb) to affix the plastic Stoppers (H) one on each end of Top Door Rail (F).
4. Using a Screw (Oo) affix the upper door rail End Caps (Nn) one on each end of Top Door Rail (F).

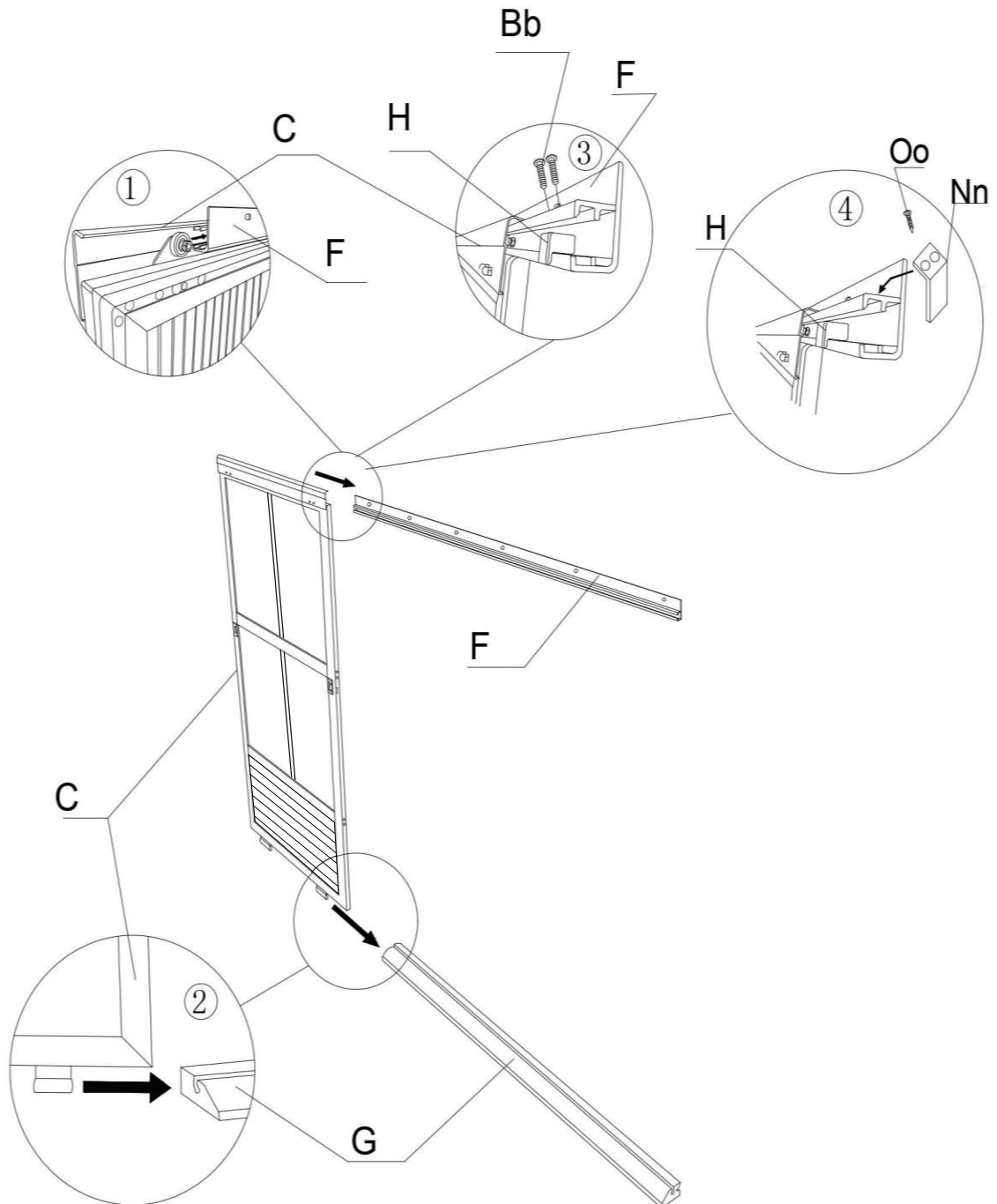

Step 4:

Please note the sliding door is suggested to be installed from the inside of the solarium.

1. Place a Bolt (Ww) through the Top Door Frame (D) and Door Top Rail (F), and place a Female Bolt (Cc-2) from the other side. Once all are inserted, tighten them all securely.
2. Secure the Bottom Door Rail (G), using a Bolt (Cc) .
3. Use Bolt (Bb) to affix the Door Latch (Dd-R, Dd-L) onto the frame.

NOTE: Adjust door accordingly so the door will slide easily.

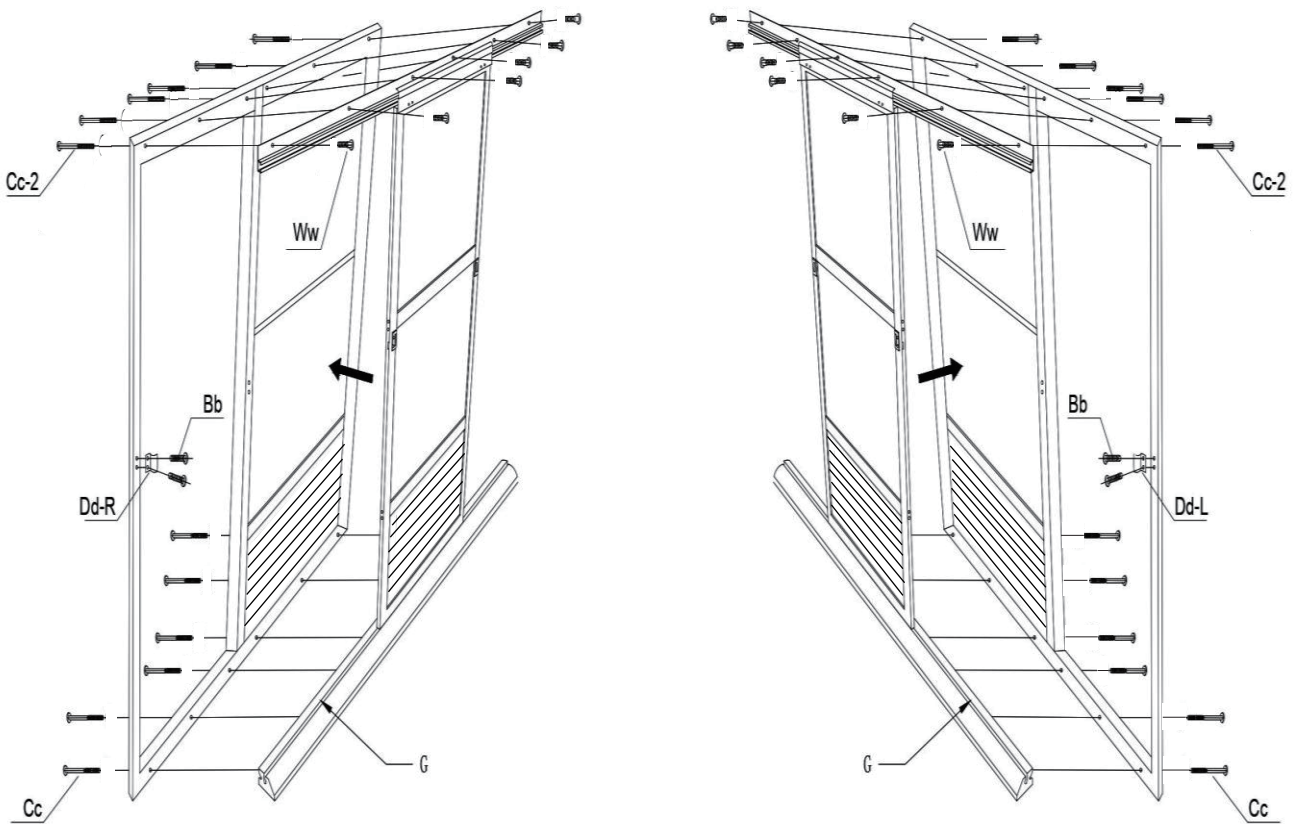
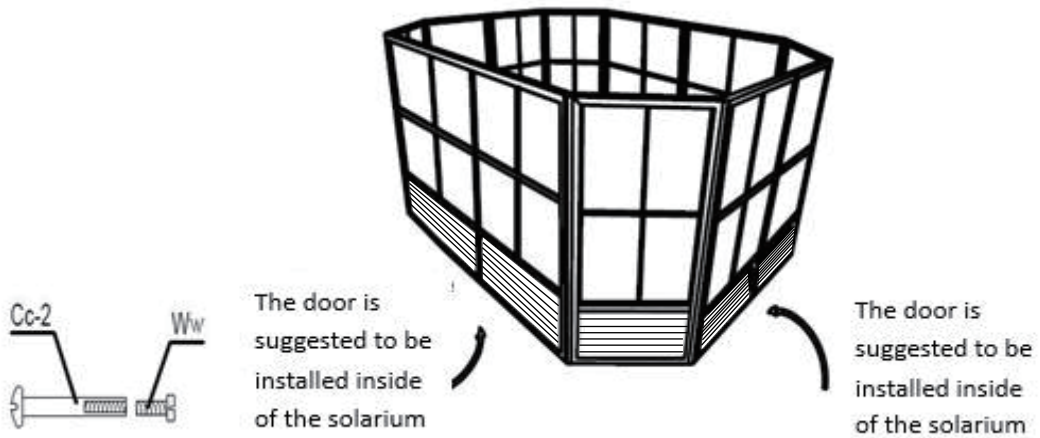

Step 5:

1. Assembled steel angle (Z2) to roof Rafters (L) using Bolts (Bb).
2. Attach roof Rafters (L) to the Central Hub (N) using Bolts (Bb).
3. Use Screws (Z) to affix the Rafters (L) onto the top of panels going through the Metal Piece (Z2) attached to the Rafter (L).

Note: Do not tighten the bolts right away as you may have to adjust the angle when inserting the roof panels.

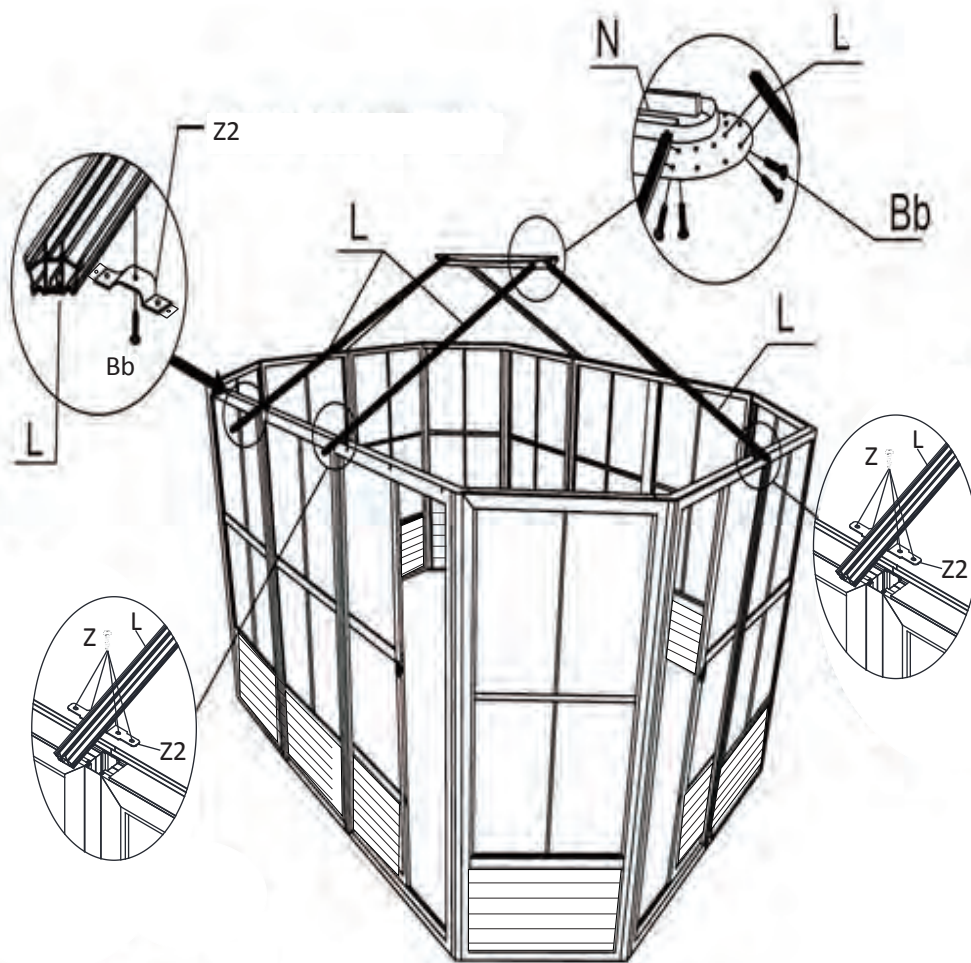

Step 6:

1. Assembled steel angle (Z1) to roof Rafters (K) using Bolts (Bb).
2. Follow the same procedure of Rafter (L) to assemble roof Rafters (K) onto the remaining panels.

Note:

1. Rafters must be affixed where panels connect to each other.
2. Affix the Rafter (K) such that, the extra hole on the bracket (Z1) are facing each other as shown below.
3. Do not tighten the bolts right away as you may have to adjust the angle when inserting the roof panels. Then tighten all screws.

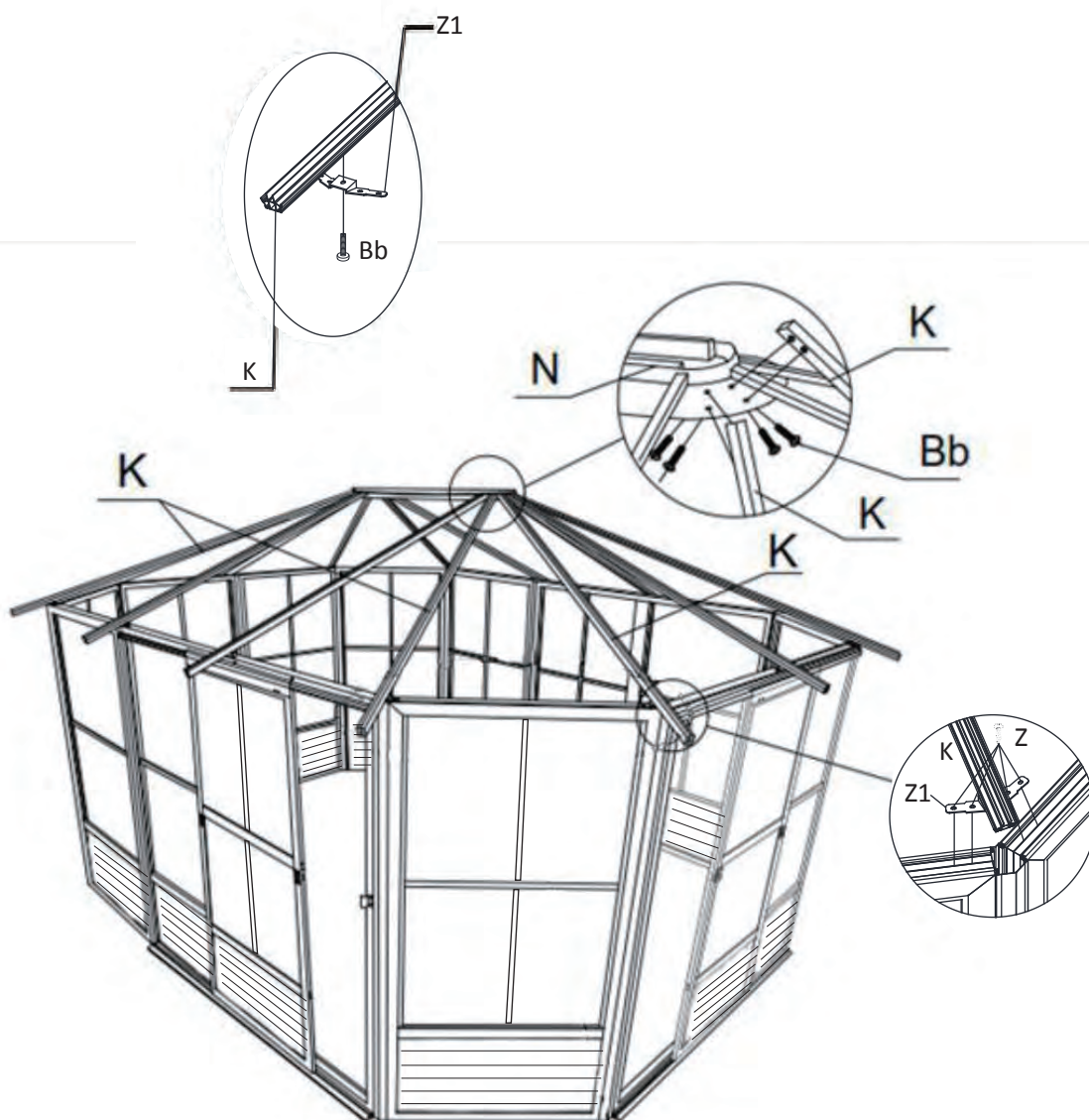

Step 7:

1. Now secure the sides of the roof with Finishing Bar (S, U, Ss and U1) with Bolts (Bb) and Brackets R/R1.
2. Place roof Finishing Bars (S, U, Ss and U1) on the right of the Roof Finishing Bar (S, U, and U1) and align the holes in each bar one on top of the other. Place End Caps (R/R1) under the aligned holes and secure with Bolts (Bb).
3. Repeat the process with the remaining Finishing Bars as illustrated.
4. In order to finish the installation of the last Finishing Bar (S, Ss, U, and U1) you have to unscrew the first Bolts (Bb) at your starting point and place an End Cap (R/R1) then re-install the Bolts (Bb).

NOTE : Make sure all screws/ bolts are tight, when finished assembling.

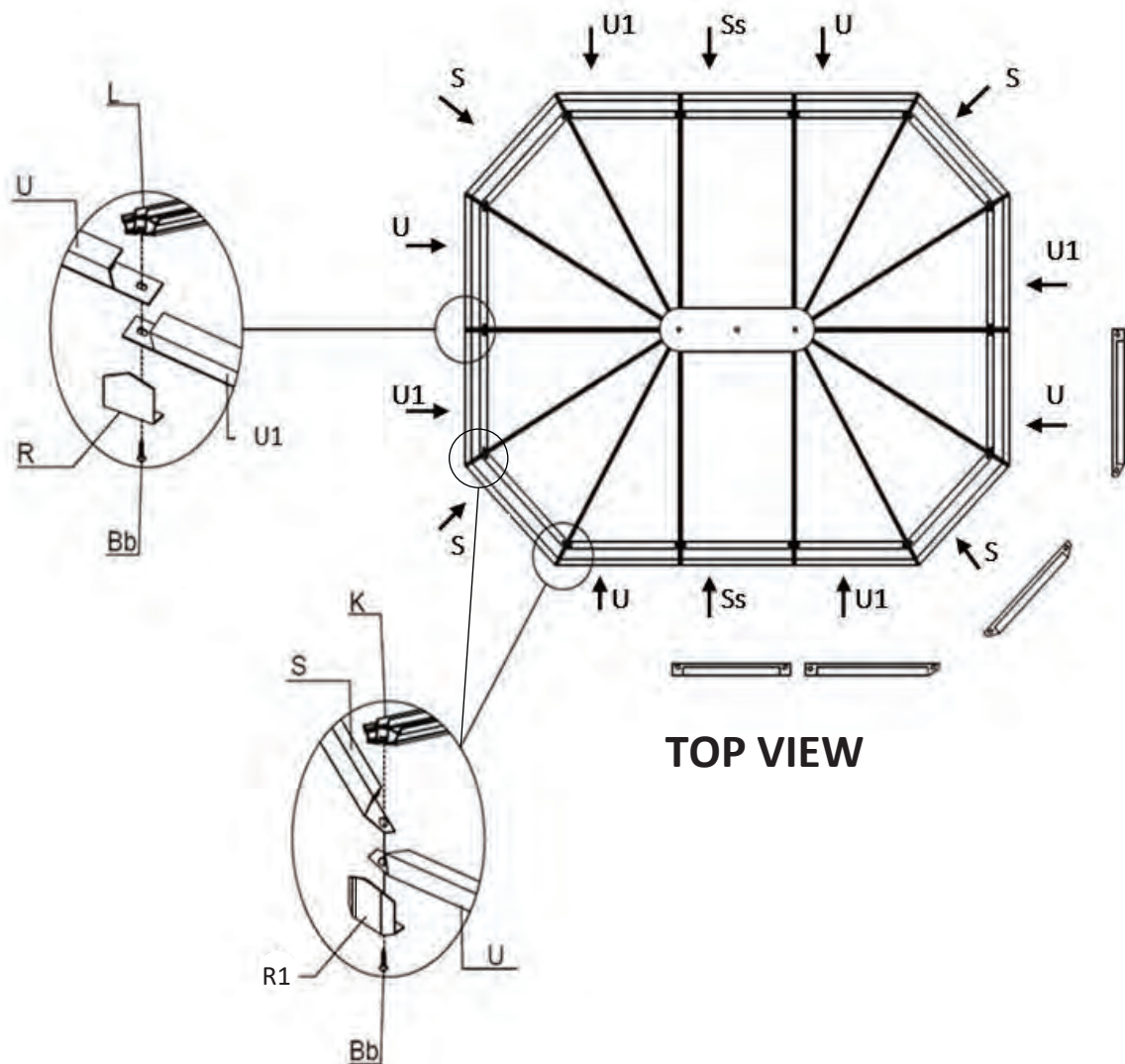

TOP VIEW

Step 8:

1. From the inside of the solarium, install all the brackets (Pp) using bolts (Bb) on the rafters L.
2. From the inside of the solarium, install all the brackets (Pp-1) using bolts (Bb) on the rafters K.
3. From the inside of the solarium, install the Solidifying Bar (T, Tt , V, and V1) as illustrated using the Bolts (Bb).

NOTE : Make sure all screws/ bolts are tight.

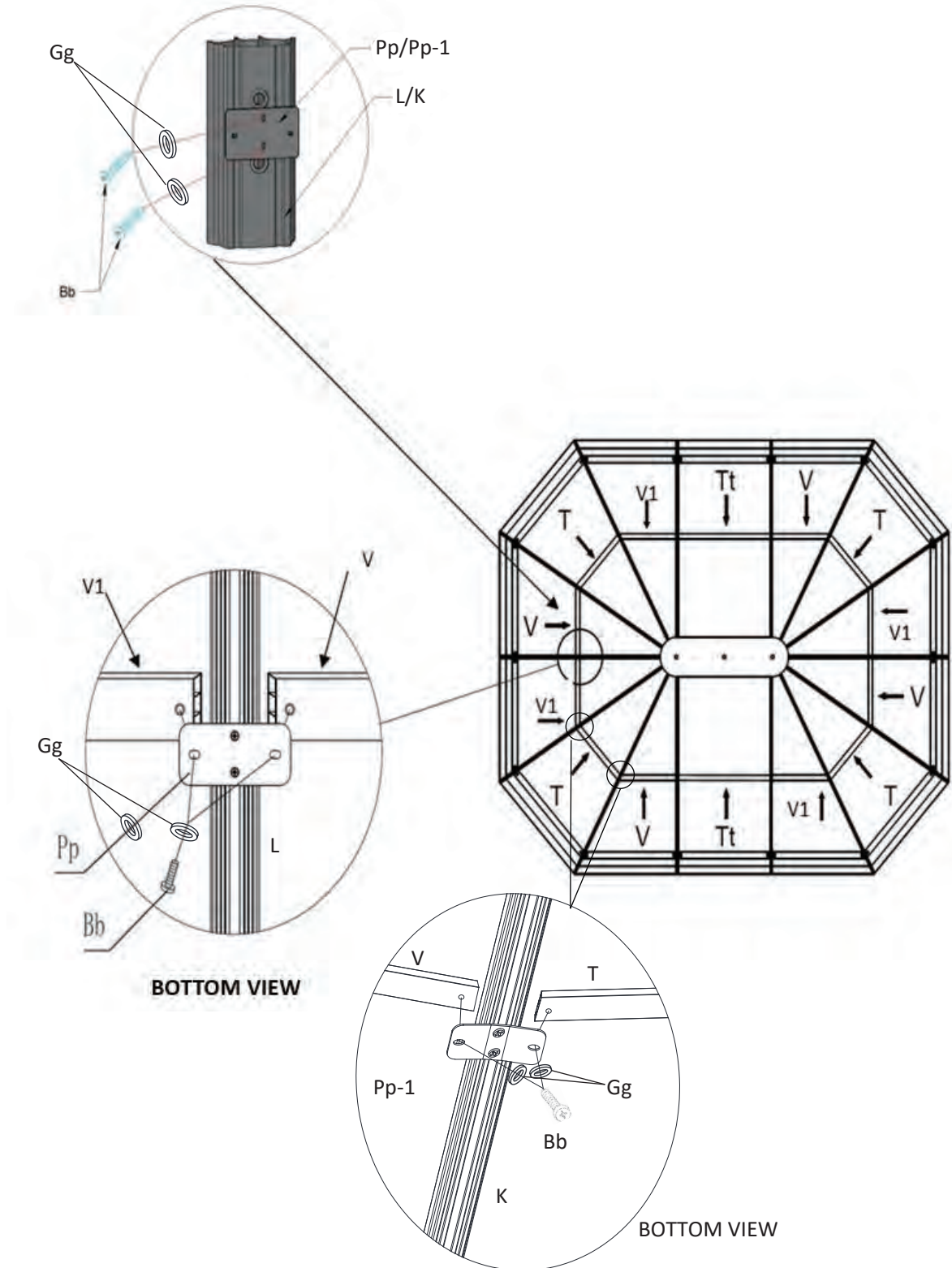

Step 9:

1. Install the bottom Roof Panels (Jj, Kk, Mm, Rr) by sliding them onto Finishing Bar (S, U, Ss & U1).

NOTE:

1. Please refer to the stickers on how to place the roof panels.
2. Make sure all screws/ bolts are tight.

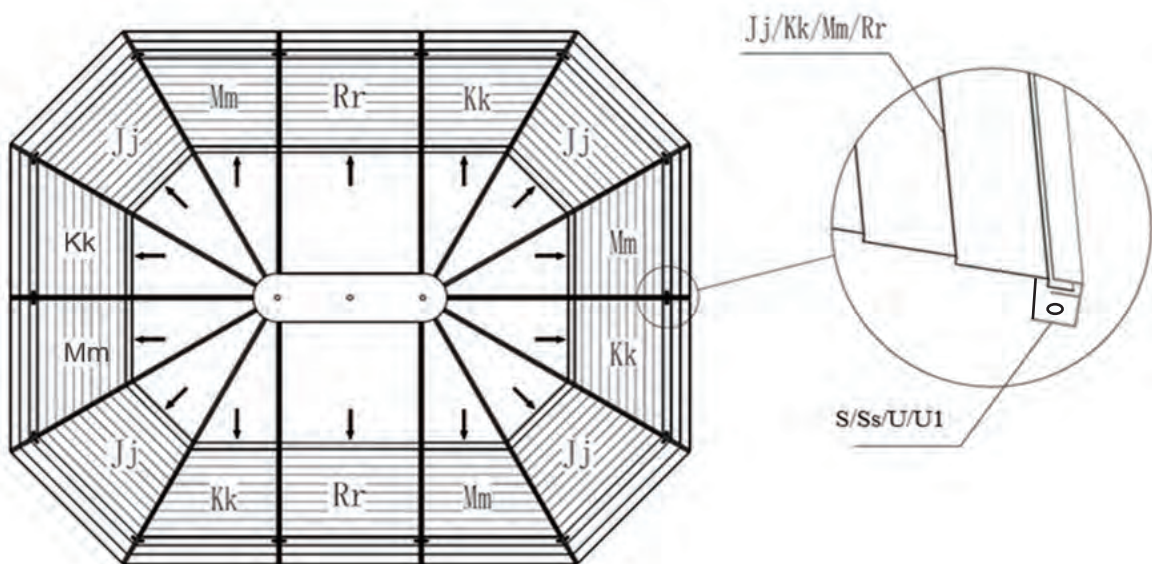

TOP VIEW

Step 10:

1. Install the upper Roof Panel (Aa) by sliding them on top of roof Rafters (K).

NOTE: Please refer to the stickers on how to place the roof panels.

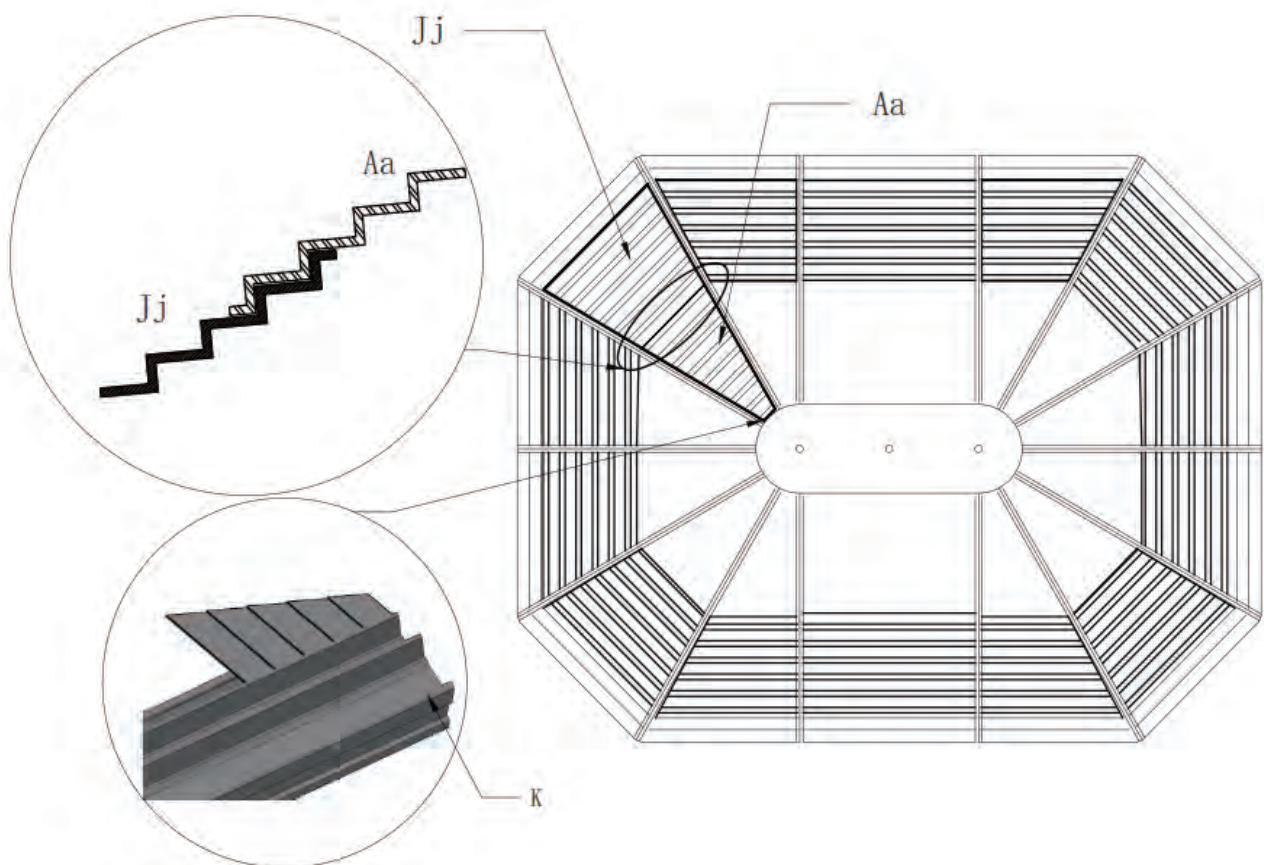

Step 11:

1. Once installation of the Roof Panel (Aa) is complete, affix it using the Cover for Rafters (O) using the Screws (Oo1) on one side only, then place another roof panel and repeat this step.

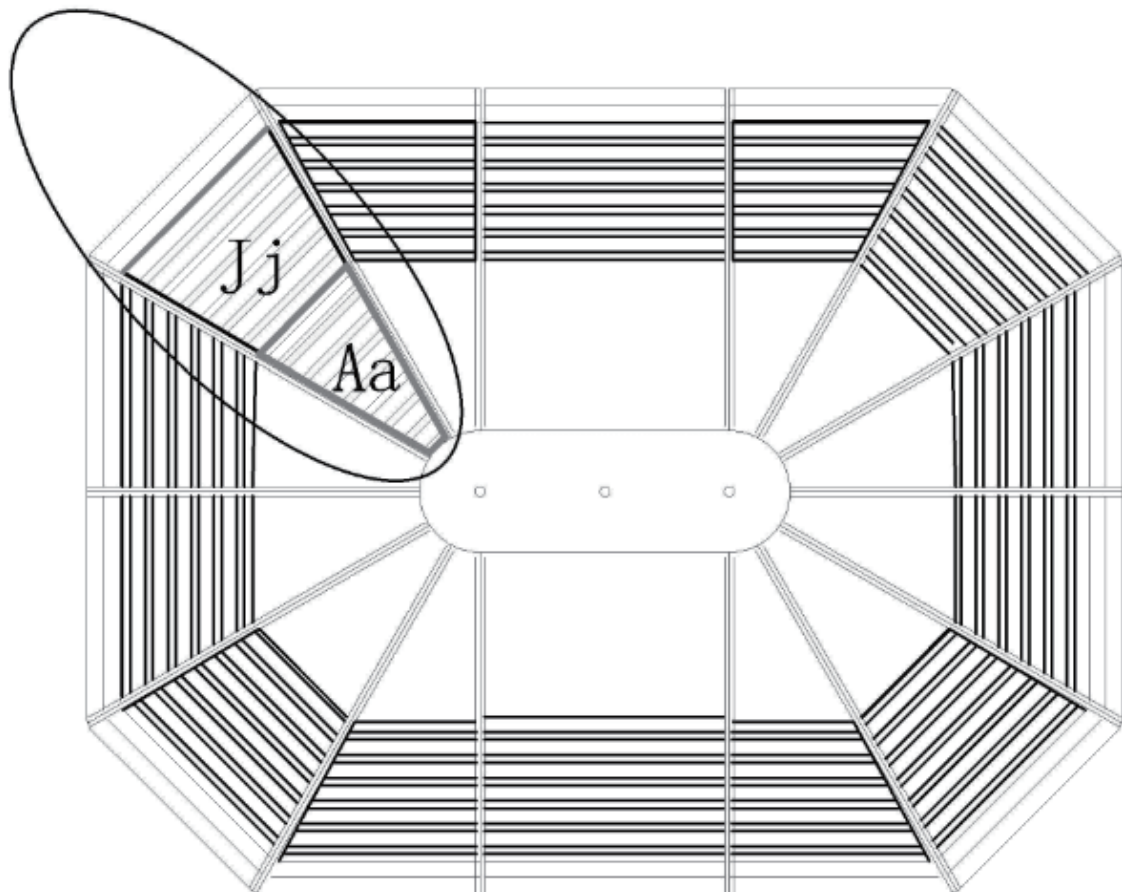
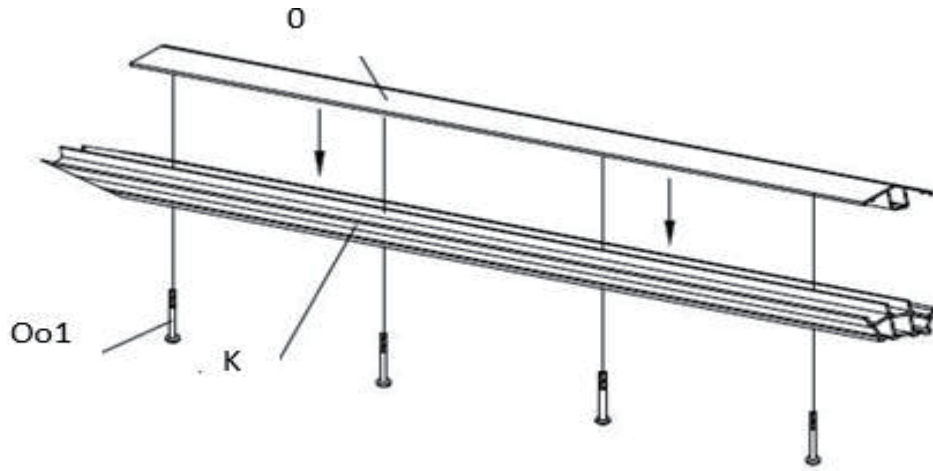

Step 12:

1. Install the Upper Roof Panels (Aa, Ll, Qq, Y) by sliding on top of roof Rafters (K, L) except for one Roof Panel (Qq) while installing Cover for Rafters (0 & 01).

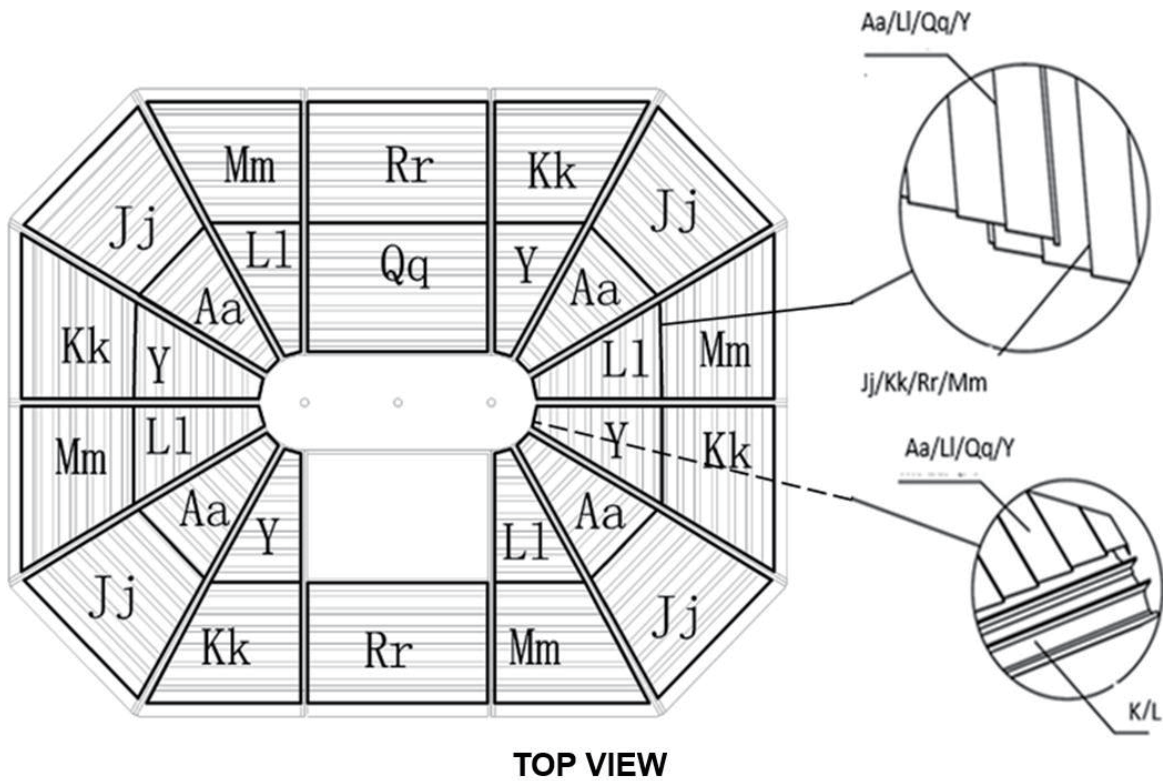
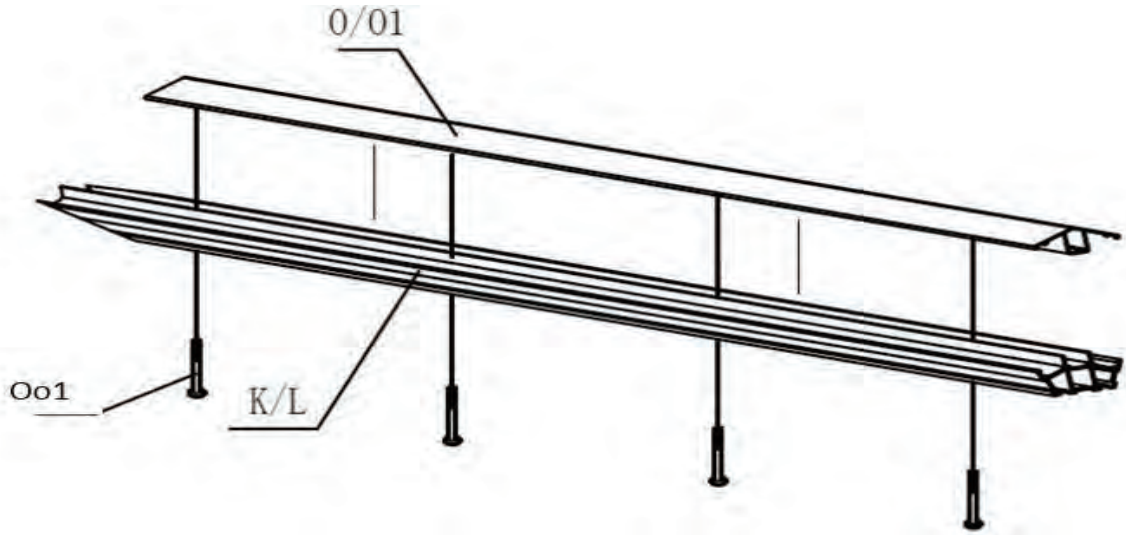

Step 13:

1. Use Nut (Hh) and Washer (Gg) to affix the Top Cap (M) to the Central Hub (N).

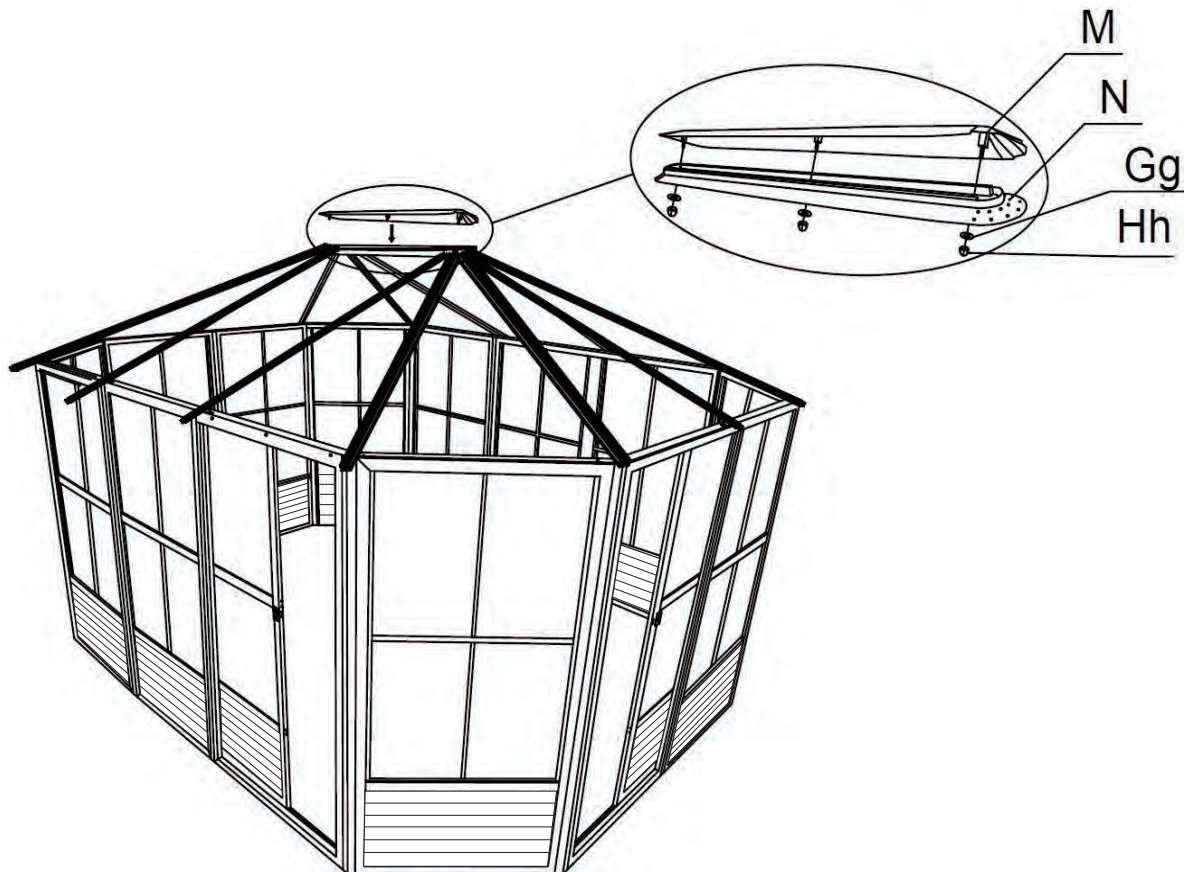

Step 14:

1. Install the last upper Roof Panel (Qq).

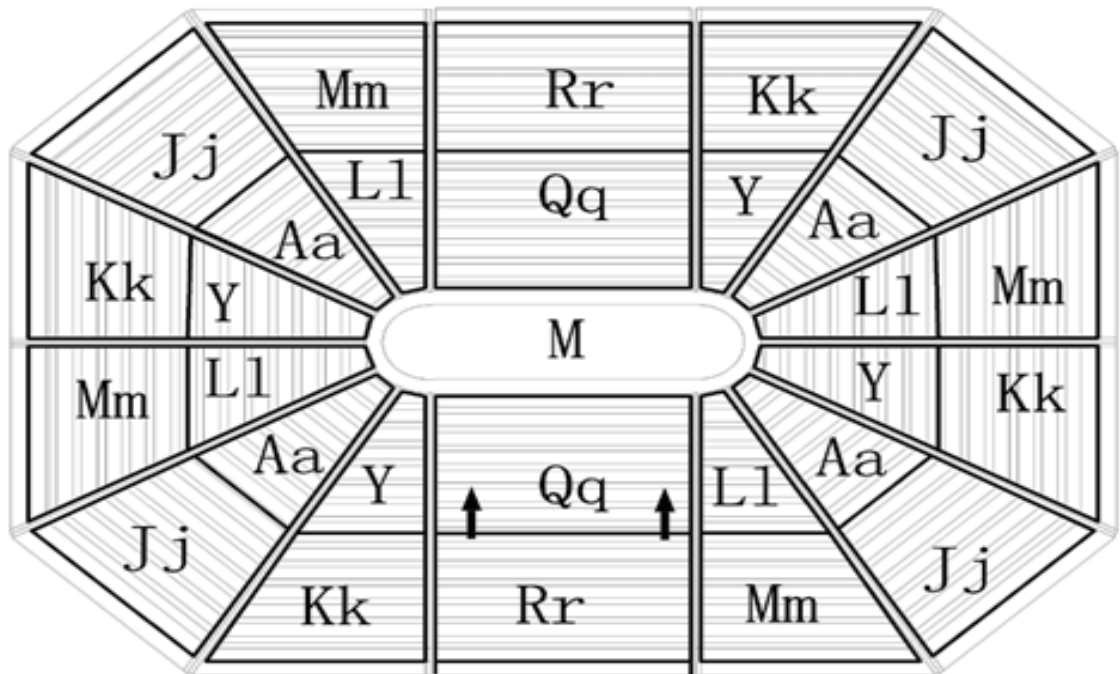

TOP VIEW

Step 15:

1. Once the last roof panel is installed, affix the Cover for Rafters (O1) to the Rafters (L) with Bolt (Oo1).

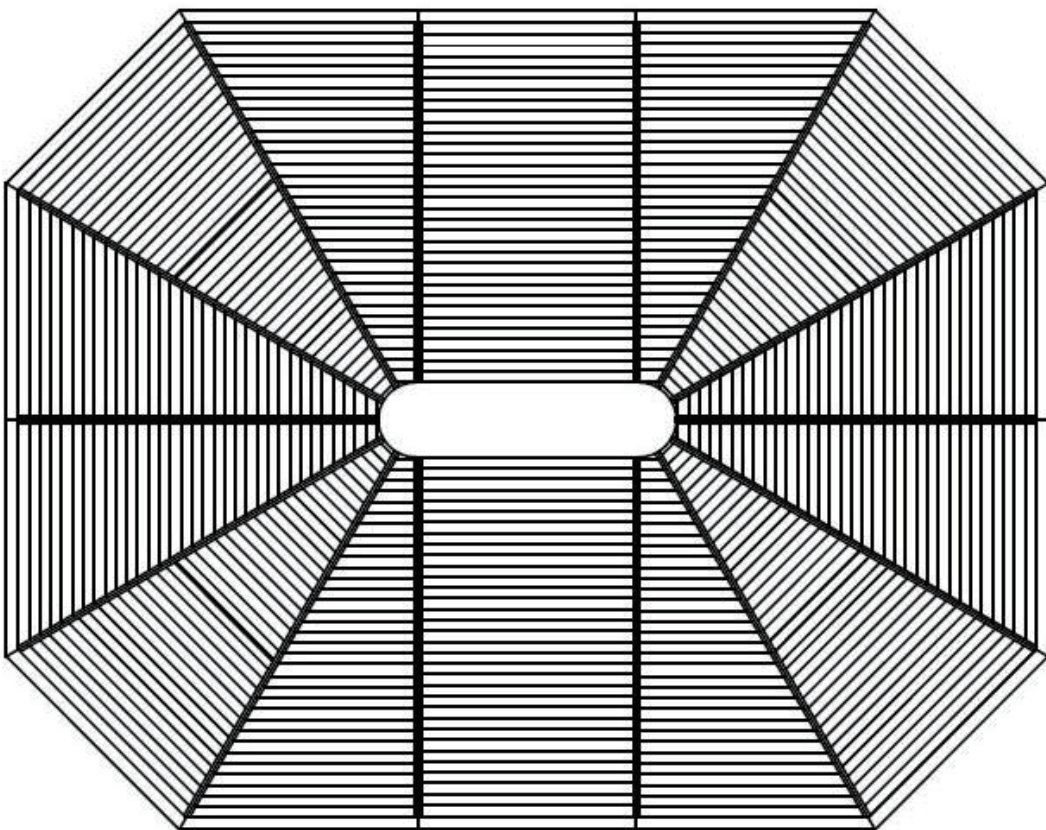
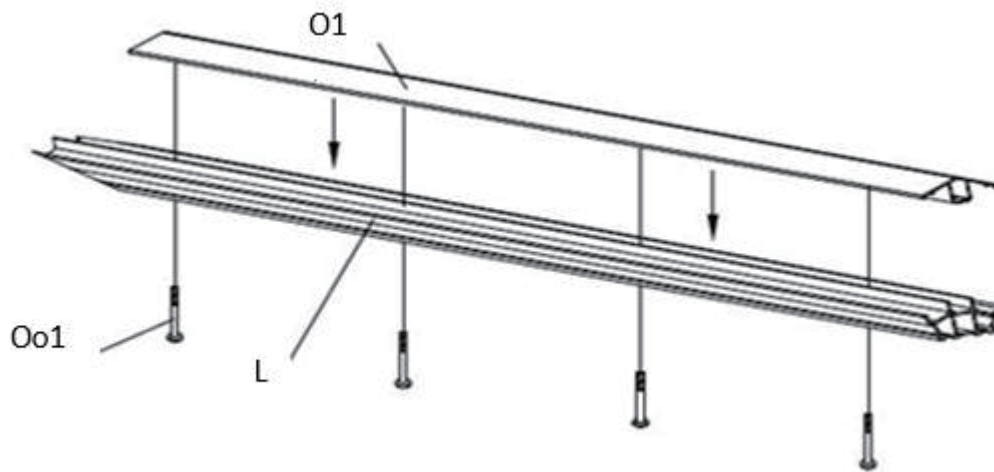

Step 16:

1. Inside each of the frames panels, push two Plastic Plugs (Ii) into the ground, and secure the unit by using two Screws (Ee) for each panel or use any other type of anchoring suitable for the floor that you are using.

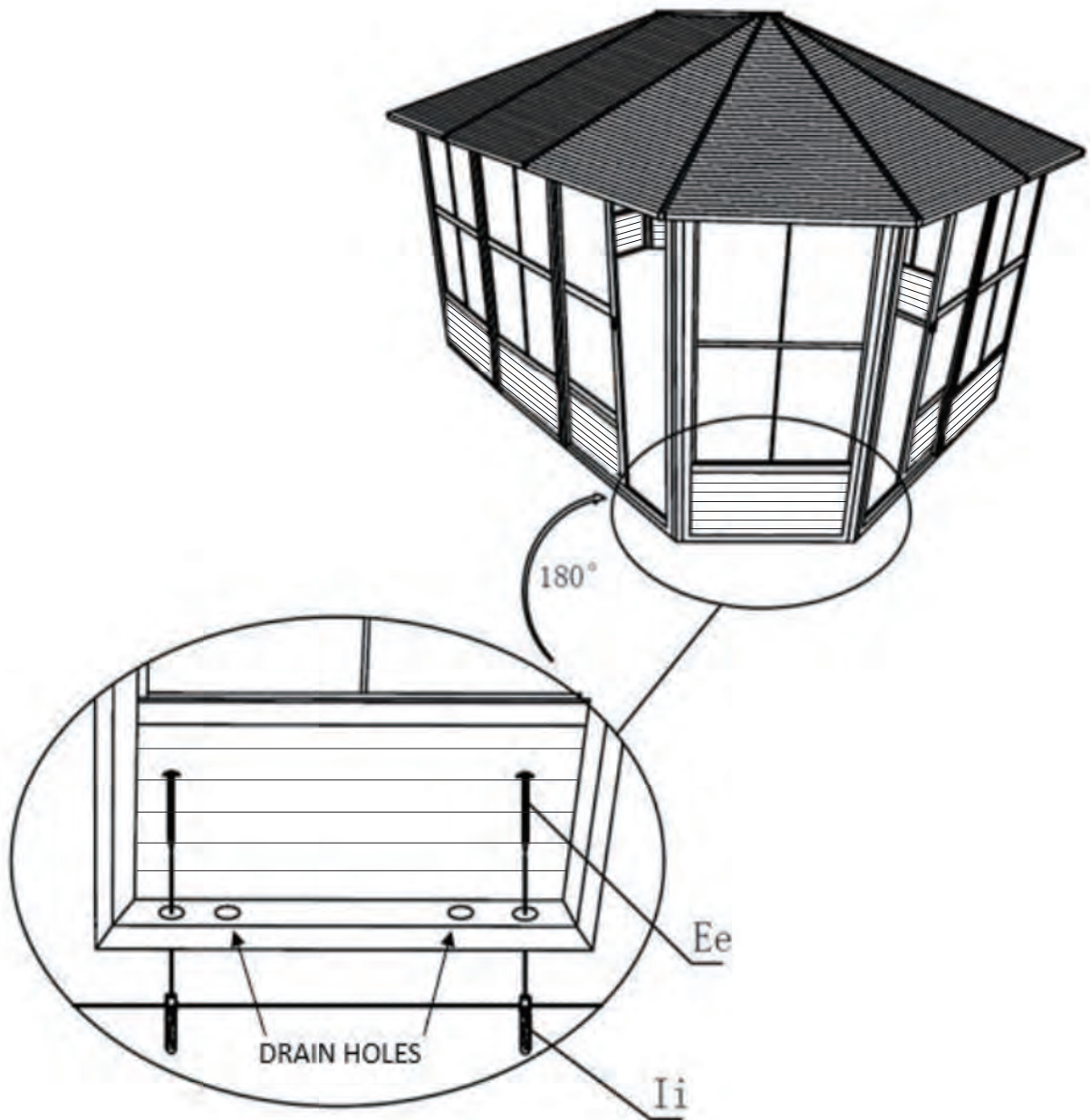

***Suggestions**

The below mentioned are only suggestions in order to permit drainage, these will vary depending on your flooring – material, flatness and slope.

For Concrete Flooring

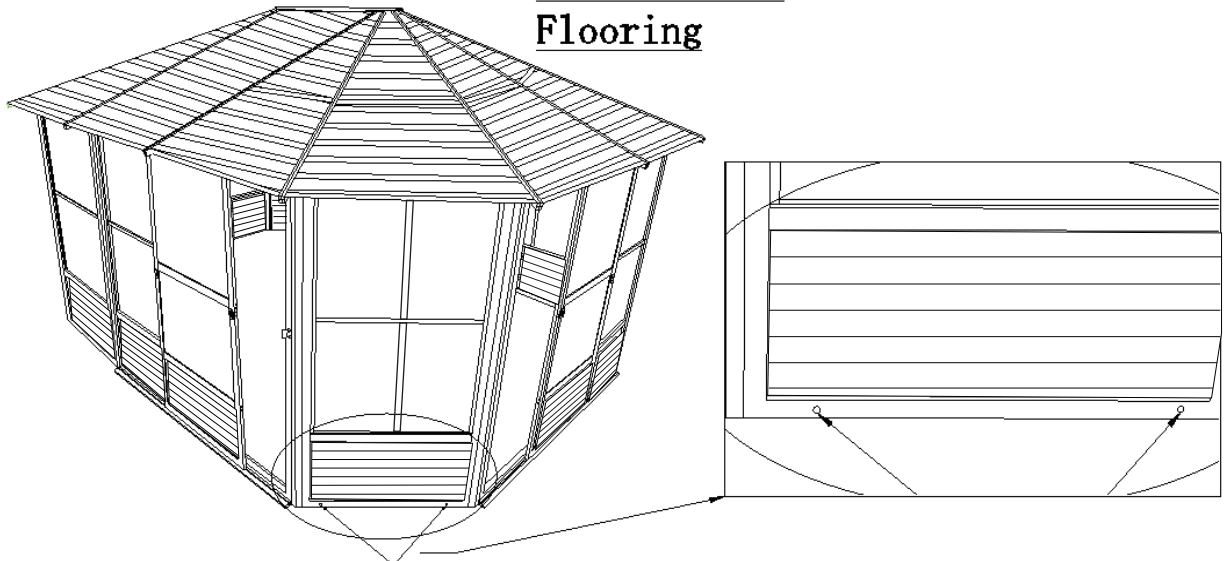

On the outside face, it is suggested to drill holes at the bottom end of the panels to permit drainage when installing on Concrete floor

For Wooden Deck

Drill through the wooden deck where drain holes are located to permit drainage

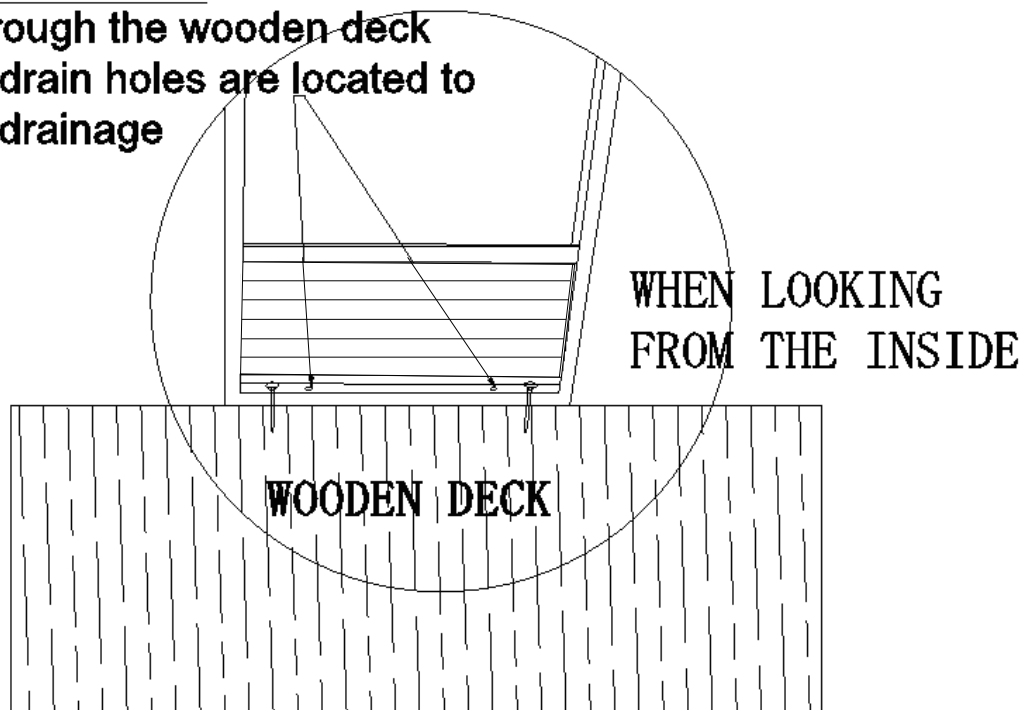

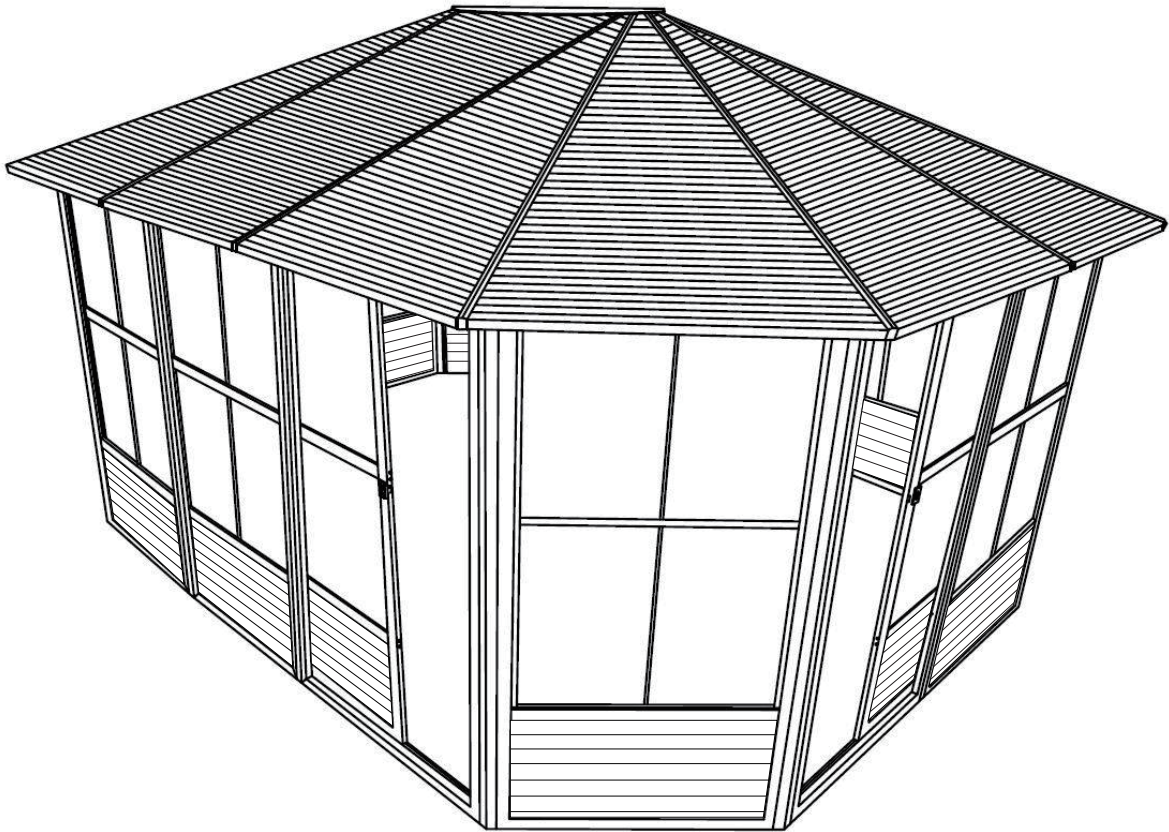
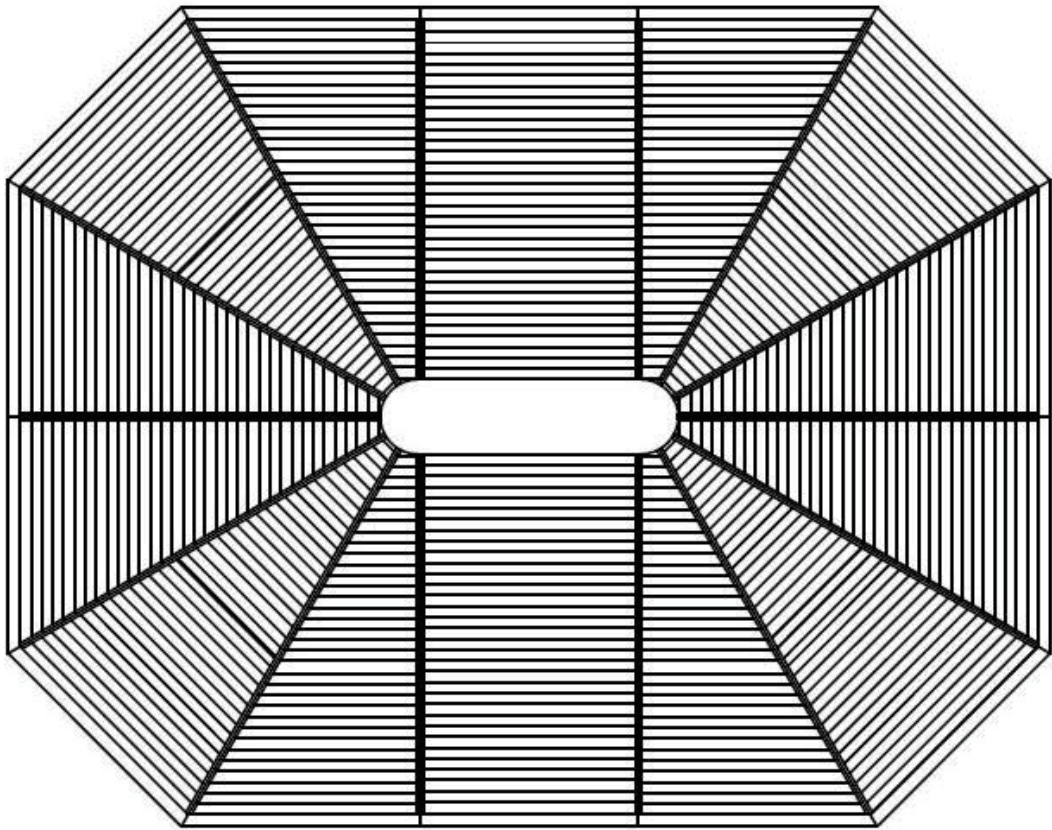

NOTE: The dimensions are approximate.

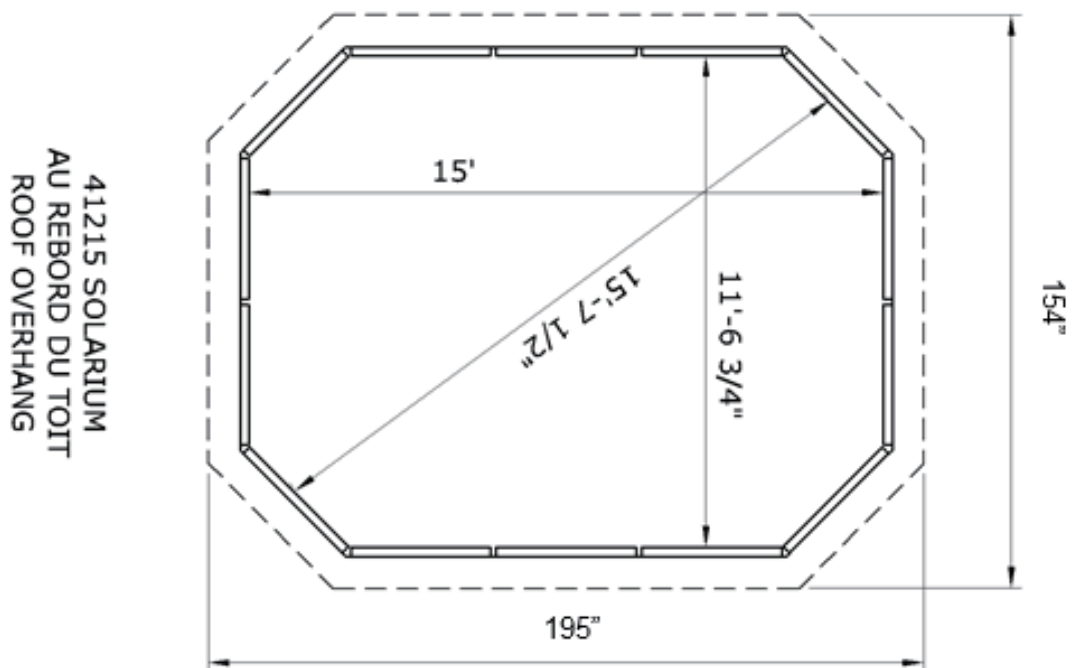
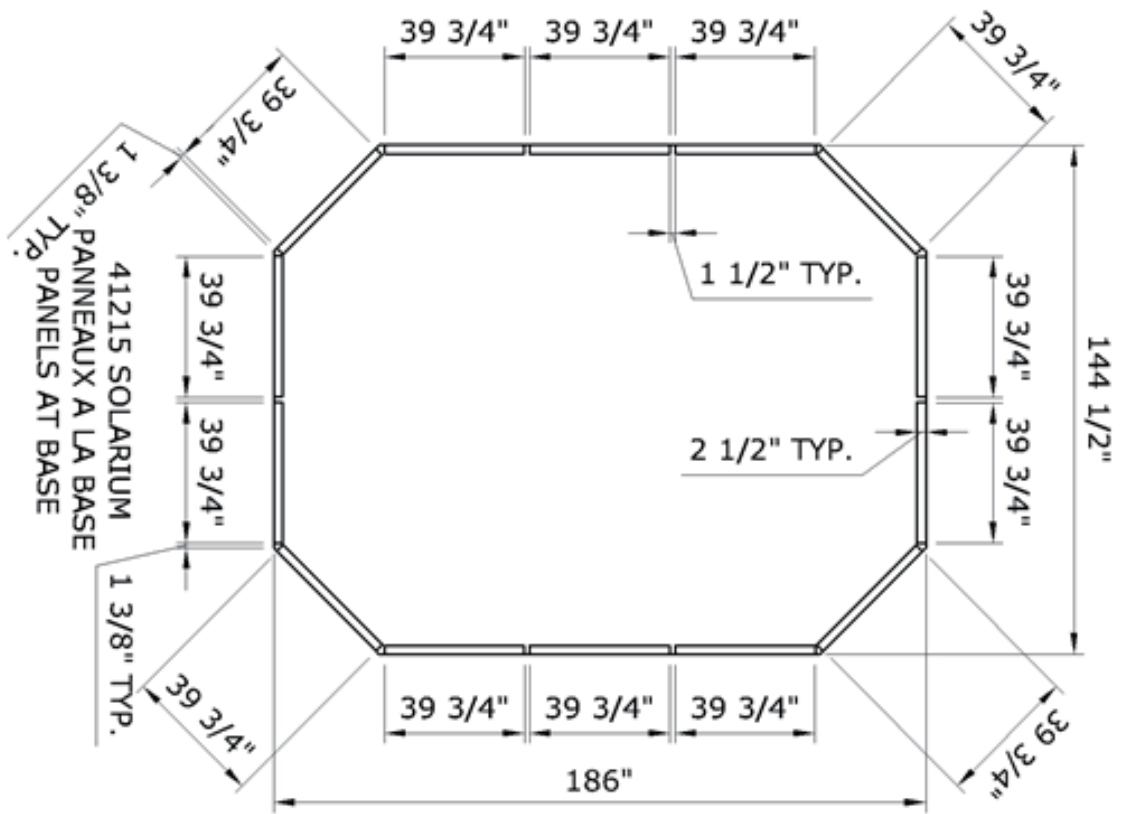

WARRANTY

Carefully inspect the contents of the package for missing or damaged components. If any parts are missing or damaged, do not return the product to the place of purchase; instead, contact the Gazebo Penguin Customer Experience Department

Montreal: (514) 276-5643

Elsewhere in Canada and the United States: 1-800-737-7174

info@gazebopenguin.com

This product has been designed and manufactured to meet the highest standards of quality and durability. Subject to the "Warranty Conditions" and "Warranty Limitations" sections below, it is warranted against defects in material or workmanship for:

- 1 YEAR ON MANUFACTURING DEFECTS

In the event that the product is damaged or the warranty period has expired, please contact the Penguin Gazebo Customer Experience Department for a complete list of replacement parts and prices.

WARRANTY LIMITATIONS AND EXCLUSIONS

1. This product is not warranted against damage caused by wind, falling objects, fire, animals, vegetation, vandalism and extreme weather conditions.
2. Collapses of shelters caused by snow, ice and wind accumulation
3. The roof must be kept free of snow and ice accumulation at all times.
4. Any damage that may be caused by snow and ice accumulation is not covered by the warranty. Snow and ice must be removed from the roof, from right to left, in five feet (5) sections at a time.
5. Removal of snow and ice from the product from the inside may damage the product and may cause serious injury to the person(s) involved in the removal.
6. It is strongly recommended that the product not be placed adjacent to buildings or trees as snow or ice may slide off the roof. In the event that the product is placed adjacent to a building or tree, additional precautions must be taken to ensure that there is no accumulation of snow or ice that could cause excessive weight to the product.
7. The product is warranted only if installed in accordance with Gazebo Penguin's written instructions included with the product.
8. Leaks due to heavy rainfall may occur. Please refer to the instruction manual for window positions and information on how to drain water.
9. The product is not guaranteed if it has been anchored improperly.
10. We reserve the right to replace or repair any defective product or part at our sole discretion.
11. No modifications or additions to the product are permitted. This will void your warranty.