



OUTDOOR STORAGE

MODEL N° 6426

OWNER'S MANUAL

Keep this Identification Number in case you need to contact our Customer Service Department.

IMPORTANT! PLEASE READ BEFORE BEGINNING ASSEMBLY

Dear Valued Customer,

We would like to congratulate you on your purchase of a Lifetime® Outdoor Storage Shed! We are confident that you have made the perfect choice and you will be very pleased with your new storage solution.

Lifetime® Outdoor Storage is part of the family of products created and manufactured by Lifetime® Products, Inc. Like all of our products, you can be assured that the quality of your Lifetime Outdoor Storage Shed is the best in the world! And, we back that quality up by offering the best warranty in the business – A 10-year warranty that fully covers the Shed!

All of our Sheds are built with the highest-quality steel and high-density polyethylene (HDPE) parts. The design and construction of our steel-reinforced double-Wall Panels is second to none. All of our exposed steel parts and gables are powder coated and we use high-density polyethylene plastic. What makes polyethylene so special? It has superior strength and durability, and, it won't crack or degrade outdoors.

So now that you know the quality you are getting in a Lifetime Outdoor Storage Shed, please take the time to **READ THIS INSTRUCTION MANUAL!**

We have taken great care in providing the best possible form of instructions to help you put your new Outdoor Storage Shed together. Before you get started, **PLEASE** read the following preparation tips to help you get started!

We can assure you, your construction experience will be a lot more enjoyable if you do!

PREPARATION TIPS:

- The first step is simple... **RELAX!** You have made a great purchase, but Rome was not built in a day. Plan to spend a good part of your weekend putting together your fine Outdoor Storage Shed. Our philosophy is, if it comes together quickly and easily, it surely will come apart quickly and easily! Your Lifetime® Outdoor Storage Shed will surely last a long, long time, if you are patient, and take all the time necessary to put it together as we have instructed.
- Grab a friend to join in on the fun! This is not a one-person endeavor. We have found that not only will things go smoother if you have two or more people participating in the construction of the Shed, but it will go quicker as well. So, the more the merrier!
- Make sure you have all the tools necessary for constructing your new Shed. There is a "Tools Required For This Assembly" list on page five of this Owner's Manual.
- The plastic pieces of your Shed may become damaged by over tightening the screws. To avoid this damage, we strongly recommend the use of a low-powered power screwdriver or a drill that has an adjustable clutch that is set on a low-torque setting. If neither is available, use a hand screwdriver. If a hand screwdriver is all you have, take several breaks... your wrist will need it!
- You will also need two small ladders (when it comes time to do the roof!).

IMPORTANT! PLEASE READ BEFORE BEGINNING ASSEMBLY

- Before beginning assembly, remove the Parts List from the center of this Owner's Manual and take an inventory of the parts included with your Outdoor Storage Shed. Also, read through the entire instruction manual. It's always a great practice to get a feel for the flow of the process and to familiarize yourself with the parts involved. But, try not to get ahead of yourself and start the process out of order.
- **FOLLOW THE INSTRUCTIONS IN ORDER!** Everything goes together in a certain order, and we have learned what that correct order should be. In our state-of-the-art research and testing facility, we have painstakingly created these instructions. The order of construction is there for a reason, and some parts simply will not fit if built out of order. Just follow along with the order in the instructions and everything will fit together and things will go very smooth.
- **YOUR SHED MUST BE BUILT ON A LEVEL SURFACE!** If the spot you have chosen to place your wonderful new Outdoor Storage Shed is not level, the Shed will not assemble correctly! We recommend a concrete patio, a wood platform or creating a pad with pea gravel. Your Shed is meant to last a lifetime, so provide the proper foundation for it before you start to build.
- Before you build it, make sure you are allowed to build it! Consult all building codes, as well as city and county ordinances, to ensure that you do not require a building permit to construct your Outdoor Storage Shed. Proper building permit documentation may be required in your neighborhood, and it would be quite unfortunate to learn this after your Outdoor Storage Shed is already built!

Now that you're ready to begin the construction of your wonderful new Outdoor Storage Shed, step back, take a deep breath, get yourself a large cold beverage and enjoy yourself. We guarantee that after spending the right amount of time in building your Shed, you will be able to enjoy it for years to come.

Thanks for choosing Lifetime®, and have fun!

ABOUT LIFETIME PRODUCTS, INC.

Lifetime Products, Inc., has applied innovation and cutting-edge technology in plastics and metals to create a family of affordable lifestyle products that feature superior strength and durability. The world's leading manufacturer of folding tables and chairs, Lifetime was founded in 1986 as the maker of portable basketball systems that revolutionized the industry with patented technology. With diverse offerings such as outdoor storage sheds and steel utility trailers, Lifetime continues to develop innovative products that outfit the way you live.

Lifetime makes the things you need for the lifestyle you want. By innovating products in and around the home, Lifetime simplifies your everyday life and enables you to get the most out of your free time.



REGISTER YOUR LIFETIME PRODUCT TODAY!

There are benefits to registering your Lifetime product. With our new online product registration form, it's fast and easy! Register with us at www.lifetime.com and enjoy these great benefits:

- Receive exclusive money-saving offers from BuyLifetime.com, our online store, as well as NEW product notifications and special closeout promotions!
- In the unlikely event of a product recall or safety modification, we will notify you.
- Registering your product guarantees you warranty service. If you do not register your product, your warranty rights will not be diminished. But you will need to provide a sales receipt to verify your product purchase date before warranty service will be provided.

LIFETIME'S PROMISE TO YOU:

Maintaining your privacy is our long-standing policy at Lifetime. And you can rest assured that Lifetime will not sell or provide your personal data to other third parties, or allow them to use your personal data for their own purposes.

We invite you to read our privacy policy at www.lifetime.com

REGISTER today!

****U.S. and Canada customers ONLY****

IF ASSISTANCE IS NEEDED,

DO NOT CONTACT THE STORE!

CALL OUR CUSTOMER SERVICE DEPARTMENT at 1 (800) 225-3865

HOURS: 7:00 a.m. to 5:00 p.m. Monday through Friday (Mountain Standard Time)

Call, or visit our Web site for Saturday hours

For customers outside the U.S. or Canada, please contact the store for assistance.



SAFETY INSTRUCTIONS



FAILURE TO FOLLOW THESE WARNINGS MAY RESULT IN SERIOUS INJURY OR PROPERTY DAMAGE AND WILL VOID WARRANTY.

To ensure safety, do not attempt to assemble this product without following the instructions carefully. Check entire box and inside all packing material for parts and/or additional instruction material. Before beginning assembly, read the instructions and identify parts using the hardware identifier and parts list in this document. Proper and complete assembly, use and supervision are essential to reduce the risk of accident or injury.

- Do not use or store hot objects such as grills, blowtorches, welding equipment, etc. near the product.
- If using a ladder during assembly, use extreme caution.
- Two capable adults are required for assembly. (It is also recommended that a third adult function as an instruction reader.)

Most injuries are caused by misuse and/or not following instructions. Use caution when using this product.

BEFORE BEGINNING ASSEMBLY



Keep the hardware bags and their contents separate. If any parts are missing, call our Customer Service Department.



Read the "Congratulations" letter on page 2-3. Identify and inventory all parts and hardware using the parts and hardware lists and identifiers in this document.

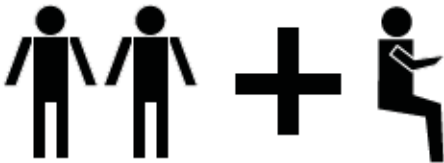

****Two adults required to complete assembly****
(+ one adult suggested as an instruction reader)

Only adults should set up the product. Do not allow children in the set-up area until assembly is complete.

IF YOU ARE INSTALLING A NEW SHED

1. Check contents of boxes and compare to parts listed on the Parts List.
2. Follow instructions that came with your shed, but add extra floor panel, wall panels, Roof Cap and Skylight at appropriate points in the assembly.

IF YOU ARE EXTENDING AN EXISTING SHED

1. Remove any bolts or screws being used to anchor the shed to the ground.
2. Remove any objects from back shelves.
3. Remove any shelves, pegboard or pegboard strips, or other objects hanging on the last two side Wall Panels on either side.
4. Check contents of boxes and compare to parts listed on the Parts List.
5. Follow the steps in this manual.
6. If you are extending an 8' x 5' shed you will need to modify the following instructions by not removing as many parts as shown in the illustrations.



TOOLS REQUIRED FOR THIS ASSEMBLY

***Phillips Screwdriver**

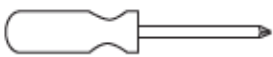

(x1)

***Electric Drill**



(x1)

7/16" Wrench



(x2)

3/8" Wrench



(x1)

Safety Glasses



(1 pair for each person)

***See "Screwdriver Notice" on page 7.**

ASSEMBLY GUIDES

Refer to the following areas throughout the instructions to assist in the assembly process:

This area is located at the top, left-hand corner of the page and indicates which tools and hardware are needed to complete the assembly steps on a page.



This area is located at the top, right-hand corner of the page and shows an image of the product with shaded parts indicating which section is being assembled.



This area is usually located in the bottom, left-hand corner of a step and indicates that special attention is needed to perform a particular part of a step.



These areas are usually located in the bottom, right-hand corner of a step and indicate that damage to the product or serious injury may occur if the caution or warning is not heeded.



Throughout the Parts & Hardware List, Part & Hardware Identifiers, and instructions are three-letter IDs. These IDs are below the images of the parts and hardware to help you locate and identify the parts and hardware during assembly. These IDs are not necessarily on the parts themselves.



ADZ (x10)
1/4" x 5/8" Pan-Head Screw

IMPORTANT NOTICES

Level Surface Notice:

Surface must be leveled before installation. We recommend building a level work space with a concrete or patio style surface. If the surface is not properly leveled, the Outdoor Shed will not assemble correctly. Proper surface leveling will save you time in the long run, so please do not ignore this step.

Building Code Notice:

Consult all local building codes, as well as city and county ordinances, to ensure that the construction of the Outdoor Shed does not require a building permit. Proper building permit documentation may be required in your neighborhood, and it would be unfortunate to learn this after constructing the Shed.

Screwdriver Notice:

You may use a #2 Phillips head screwdriver bit and a power screwdriver or drill, instead of a hand screwdriver. However, be aware that the plastic pieces of your Shed can be damaged by overtightening of screws. To avoid damage we strongly recommend the use of a low-powered power screwdriver or a drill that has an adjustable clutch that is set on a low torque setting. If neither is available, use a hand screwdriver. In any case use caution to avoid overtightening the screws.

Floor Puncture Notice:

Sharp objects may damage your floor. If resting sharp, heavy objects on your Shed floor, place a block of wood between the sharp object and floor.

CAUTION:

If more than six (6) inches of snow accumulate on the roof of the shed, carefully remove the snow to avoid possible roof collapse. While standing on the ground, remove the snow from the roof with a broom or snow shovel. Do not stand on the roof to remove snow.

Snow Load Kit available from Customer Service for high snow areas.

PARTS & HARDWARE LIST

ID	Description	Quantity	ID	Description	Quantity
Main Parts					
AFY	Center Roof Cap	2	ADZ	1/4" x 5/8" Phillips Pan-Head Screw	60
AFH	Truss Gutter Channel	4	AJA	Foam Cube	4
AFQ	Wall Support Channel	4	ACJ	#10 x 5/8" Phillips Pan-Head Screw	4
AFG	Truss Brace Channel	2	AED	#10 x 1" Fender Washer	4
AGQ	Center Roof Panel	4	BGU Window Assembly x2		
AHD	Wall Panel	2	ADZ	1/4" x 5/8" Phillips Pan-Head Screw	4
AHH	Window Wall Panel	2	ADW	#10 x 3/4" Phillips Pan-Head Screw	4
AHG	Window Frame	4	AEE	#10 x 1/2" Flat Washer	2
AGJ	Center Floor Panel	4	ACF	#10 x 5/16" Phillips Pan-Head Screw	2
AFL	Roof Support Strip	12	AIE	Mounted Window Stay	2
AHF	Window	4	AIN	Sliding Window Stay	2
AFP	Truss Support Strip	4	AIU	Window Latch Bearing	4
BJO 6426 Hardware Bag			AIT	Window Latch	4
BGV Truss Assembly Hardware x2			ADX	#10 x 1/2" Phillips Pan-Head Screw	22
AAK	1/4" x 1 1/2" Hex Bolt	10	AIV	Window Stay Bracket	2
ADJ	1/4" Cap Nut	10	AIR	Window Hinge	4
AIP	Truss Gutter Connector	1	ACB	#10 x 1 1/4" Phillips Pan-Head Screw	4
AHT	Floor Bracket	2	ADK	#10 Cap Nut	2
			ACD	#10 x 3/8" Flat-Head Screw	2

HARDWARE IDENTIFIER

TRUSS ASSEMBLY HARDWARE [BGV] x2

Hardware shown at actual size (*unless indicated otherwise)

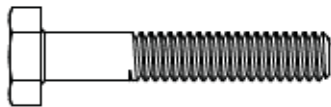

AAK (x10)
1/4" x 1 1/2" Hex Bolt



ADJ (x10)
1/4" Cap Nut



AHT (x2)*
Floor Bracket

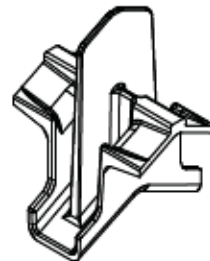

AIP (x1)*
Truss Gutter Connector

WALL & ROOF INSTALLATION HARDWARE [BGT] x2

Hardware shown at actual size (*unless indicated otherwise)



AJA (x4)*
Foam Cube

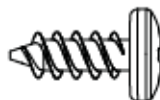

ADZ (x60)
1/4" x 5/8" Phillips Pan-Head Screw



ACJ (x4)
#10 x 5/8" Phillips Pan-Head Screw

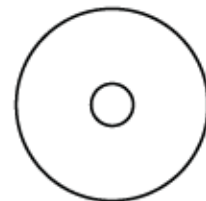

AED (x4)
#10 x 1" Fender Washer

HARDWARE IDENTIFIER

WINDOW ASSEMBLY HARDWARE [BGU] x2

Hardware shown at actual size

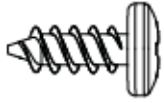

ADZ (x4)
1/4" x 5/8" Phillips Pan-Head Screw



ADW (x4)
#10 x 3/4" Phillips Pan-Head Screw



ADX (x22)
#10 x 1/2" Phillips Pan-Head Screw



ADK (x2)
#10 Cap Nut



ACD (x2)
#10 x 3/8" Flat-Head Screw



AEE (x2)
#10 x 1/2" Flat Washer



ACF (x2)
#10 x 5/16" Phillips Pan-Head Screw



ACB (x4)
#10 x 1 1/4" Phillips Pan-Head Screw

Hardware shown at 25% of actual size



AIE (x2)
Mounted Window Stay



AIN (x2)
Sliding Window Stay

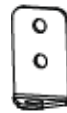

AIV (x2)
Window Stay Bracket

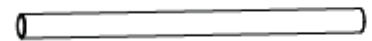

AIR (x4)
Window Hinge

Hardware shown at 50% of actual size



AIU (x4)
Window Latch Bearing

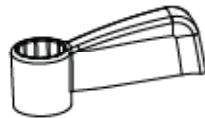

AIT (x4)
Window Latch

PARTS IDENTIFIER

Parts shown at 4% of actual size

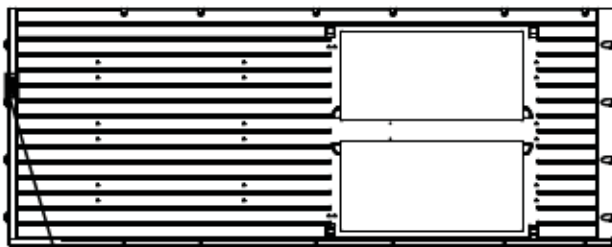

[100XXXX]

AHH (x2)
Window Wall Panel

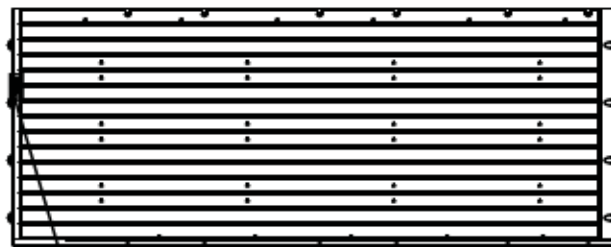

[1000272]

AHD (x2)
Wall Panel

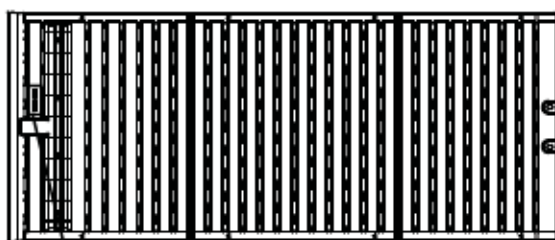

[1000476]

AGQ (x4)
Center Roof Panel

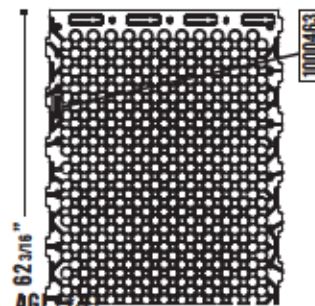

AGJ (x4)
Center Floor Panel

PARTS IDENTIFIER

Parts shown at 8% of actual size

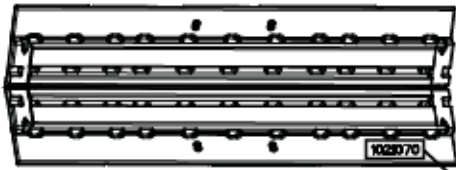

AFY (x2)
Center Roof Cap

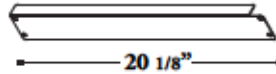

AFP (x4)
Truss Support Strip

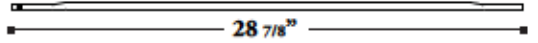

AFL (x12)
Roof Support Strip

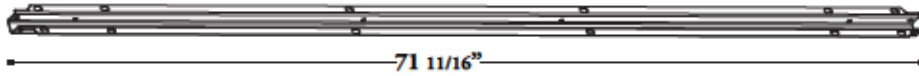

AFH (x4)
Truss Gutter Channel

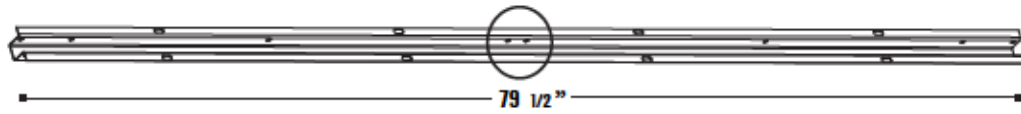

AFG (x2)
Truss Brace Channel



AFQ (x4)
Wall Support Channel

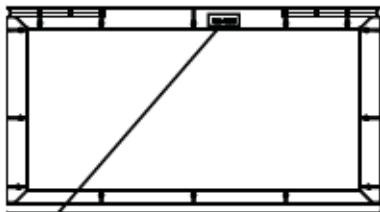

AHG (x4)
Window Frame

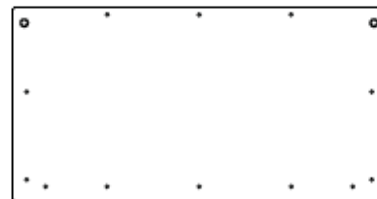

AHF (x4)
Window



TOOLS AND HARDWARE REQUIRED FOR THIS PAGE

SEC 1



USE THE SAME TOOLS AND REQUIRED MATERIALS INDICATED IN YOUR SHED'S OWNER'S MANUAL



SEC

1.1

SITE SELECTION

This extension kit adds an additional 60" to the length of your shed. Before beginning expansion of your shed, ensure your site can accommodate the new size. Add 60" to the length of your site's wooden platform (shown) or cement platform; the width will remain the same. This may require the use of additional lumber or other materials.

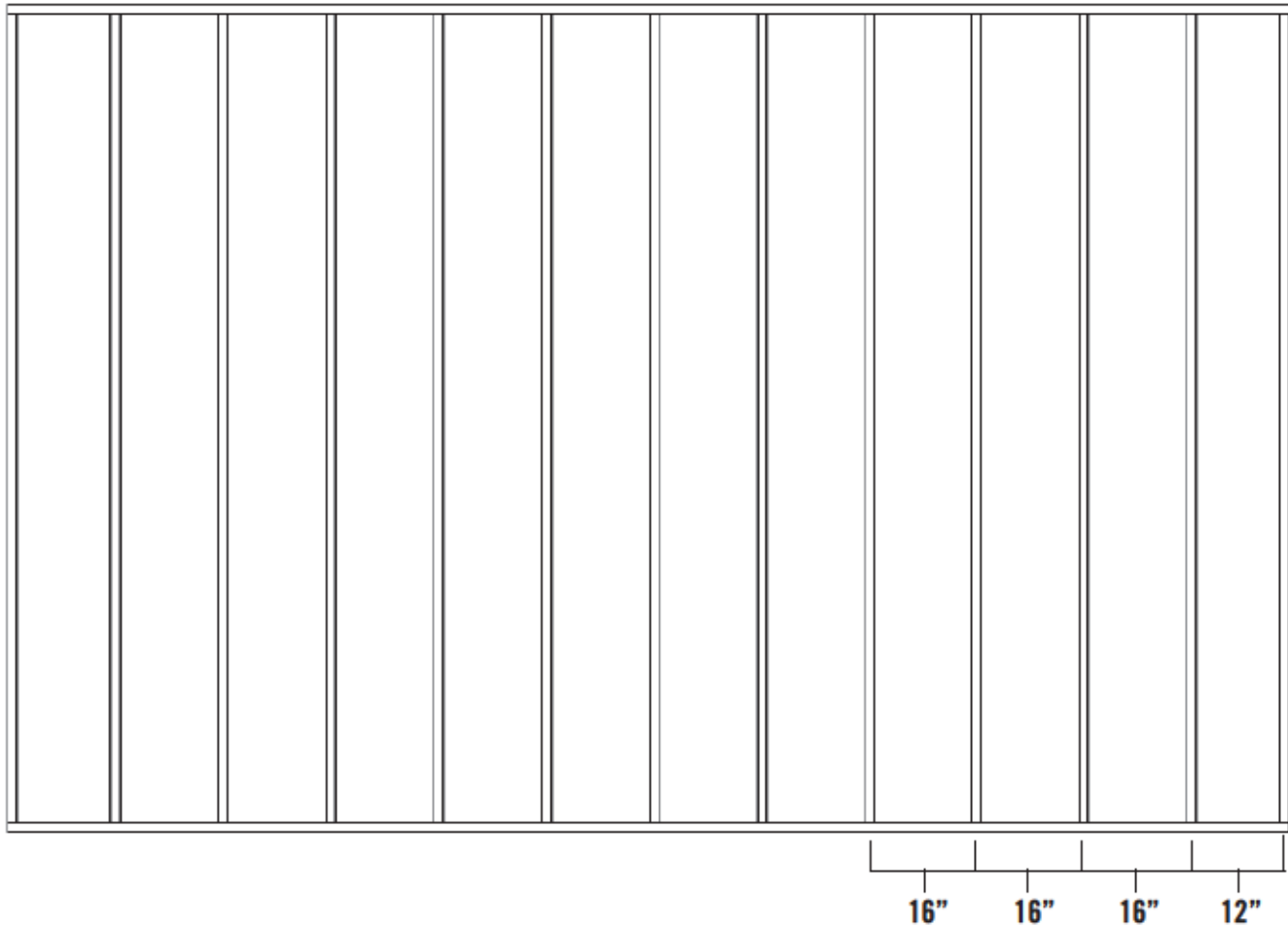

Note: Floor studs are all 16" on center with one at 12" on center at the end. Refer to Site Selection & Platform Instructions in Owner's Manual.



TOOLS AND HARDWARE REQUIRED FOR THIS PAGE

SEC 2



NO HARDWARE REQUIRED FOR THIS PAGE



****SAVE ALL HARDWARE FOR RE-ASSEMBLY!****

If your existing shed is anchored to the ground, remove all anchoring hardware before following these steps.

SEC

SHED DISASSEMBLY

2.1

Remove the four Center Roof Panels and two Center Roof Caps highlighted below.

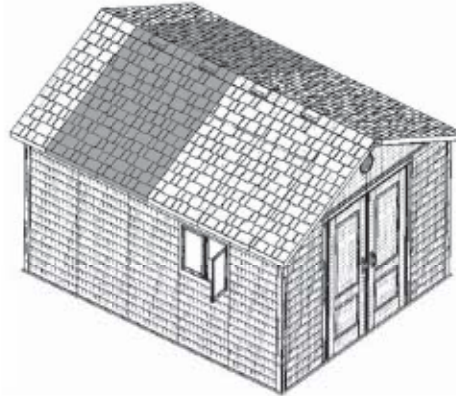

! *Note: Your shed may be shorter than one shown above. Skip the very back Roof Panels (slightly more narrow than the middle Roof Panels) and then remove the next two Roof Panels from each side of the shed (along with the connected Roof Caps).*

SEC

2.2

Remove all Screws from the highlighted Wall Panel that connect it to adjoining Wall Panels and to the Wall Support.

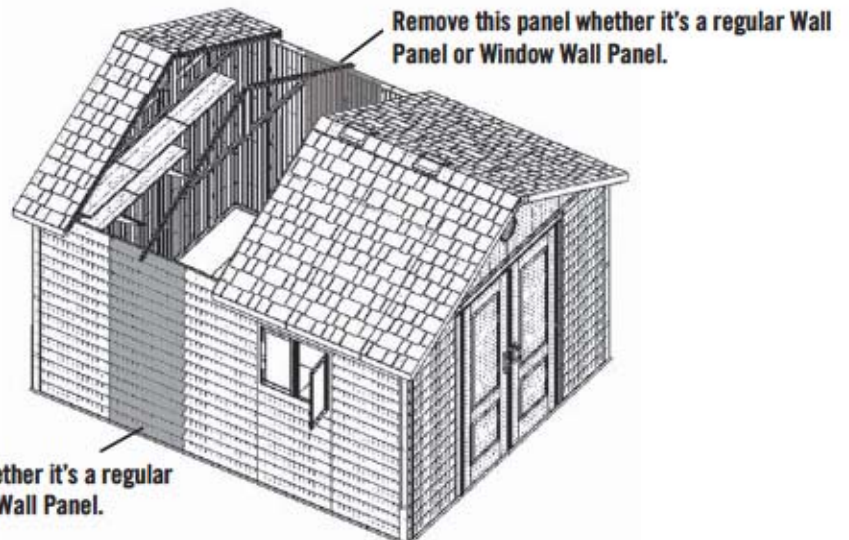



TOOLS AND HARDWARE REQUIRED FOR THIS PAGE

SEC 2



NO HARDWARE REQUIRED FOR THIS PAGE



SEC

2.3

Tip the Wall Panel inward.

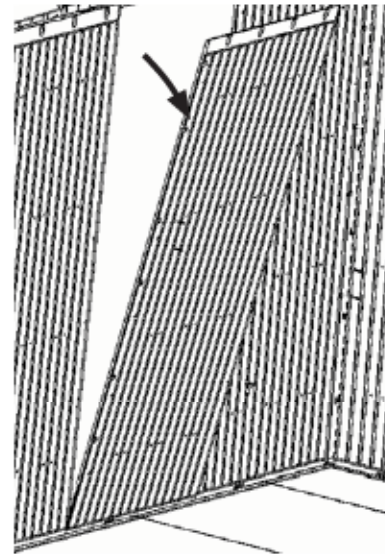

Note: Your Shed may be a different length than the Shed shown, but the ideas are the same.

SEC

2.4

Use a long flat screwdriver to gently pry the bottom corner of the Wall Panel so that it has room to slide on the inside of other Wall Panels. Slide the Wall Panel to the left, and then remove the Panel. **Repeat Steps 2.2 - 2.4 for the other side of the shed.**

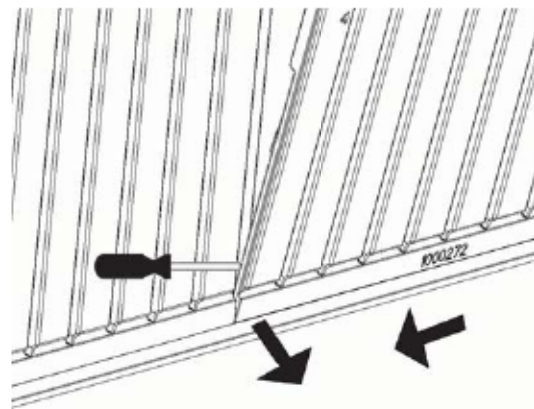

Note: To remove a Wall Panel, slide it to the left (when looking at it from inside the shed) until it lifts out.



TOOLS AND HARDWARE REQUIRED FOR THIS PAGE



NO HARDWARE REQUIRED FOR THIS PAGE

SEC 2



SEC

2.5

Remove the Truss Assembly and set it aside for later.

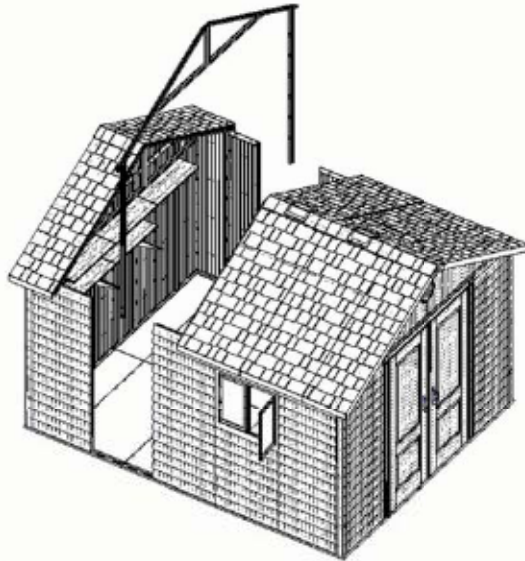

CAUTION

As you remove the Wall Panels, have one person support the Truss assembly so that it does not fall over.

SEC

2.6

With at least one person on each side of the shed, tip the back section of the shed forward to about a 45° angle and slide the back section away from the shed.

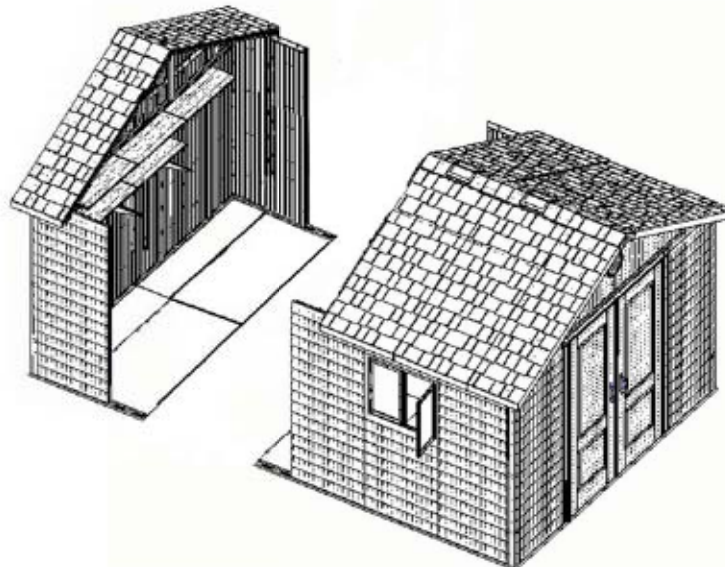

SEC 3 FLOOR ASSEMBLY

PLASTIC PARTS REQUIRED

Part shown at 4% of actual size

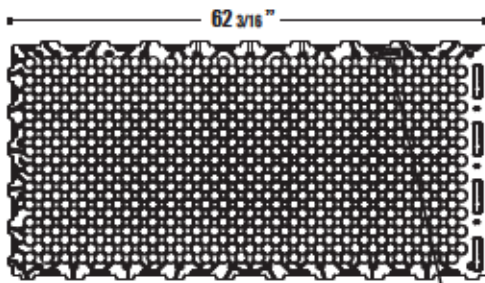

1000463

AGJ (x4)
Center Floor Panel

TOOLS REQUIRED



Safety Glasses



TOOLS AND HARDWARE REQUIRED FOR THIS PAGE

SEC 3



NO HARDWARE REQUIRED FOR THIS PAGE



SEC

FLOOR ASSEMBLY

3.1

Fit together the four **Center Floor Panel (AGJ)** extensions.

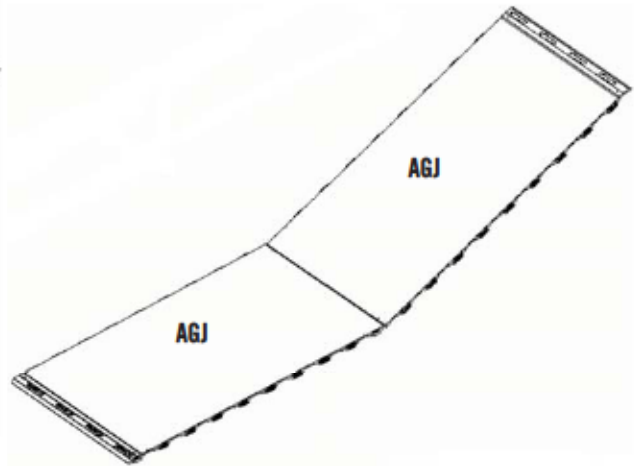
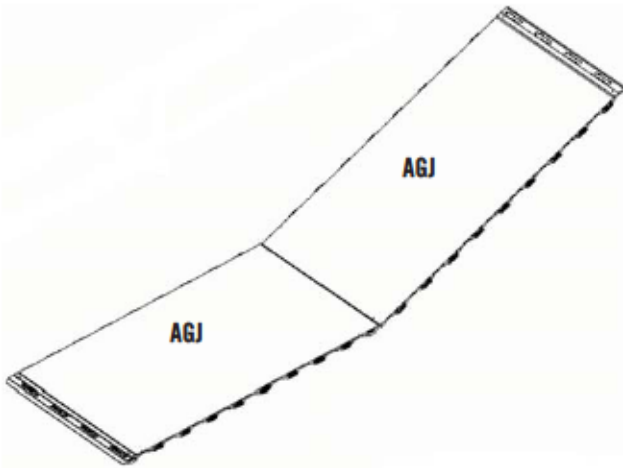

SEC

3.2

Tip the **Center Floor Panel Assemblies** forward at a 45° angle and connect them to the **Center Floor Panels** on the main section of the shed.

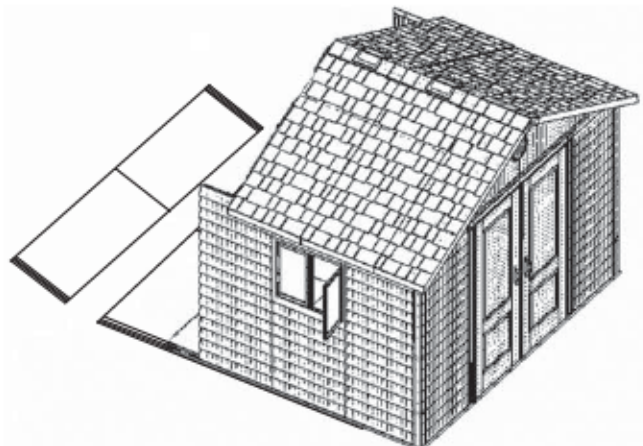
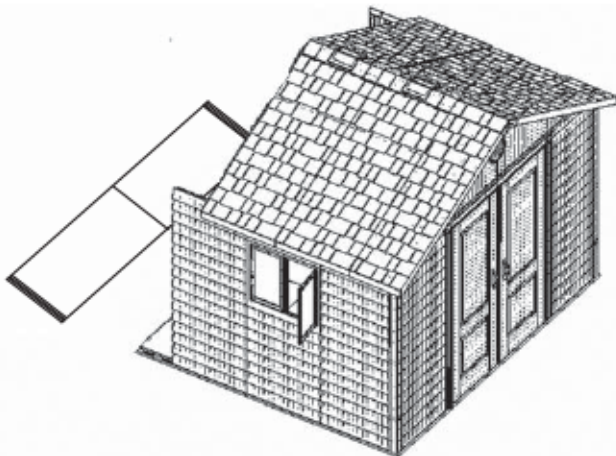



TOOLS AND HARDWARE REQUIRED FOR THIS PAGE



NO HARDWARE REQUIRED FOR THIS PAGE

SEC 3



SEC

3.3

With at least one person on each side of the shed, tip the back section of the shed forward at about a 45° angle and slide it forward to re-connect it to the rest of the shed.

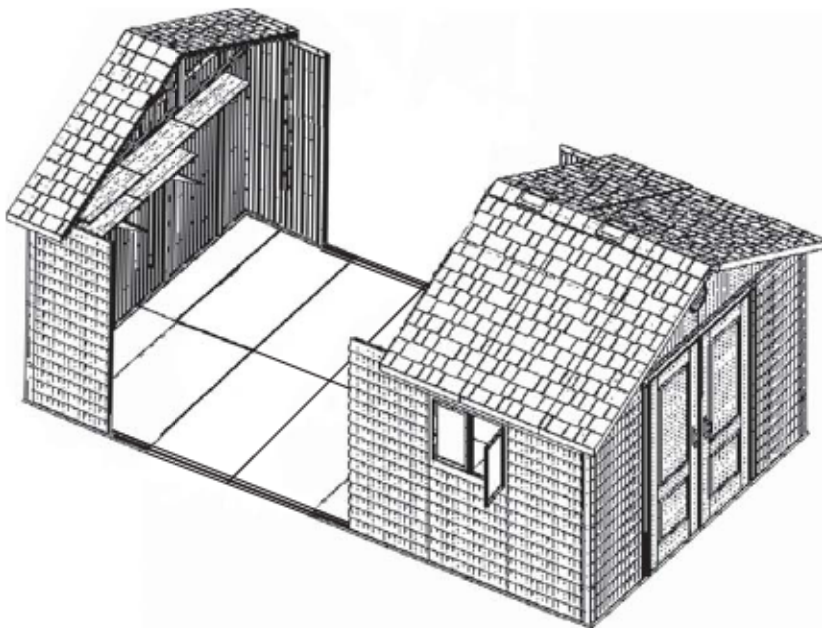
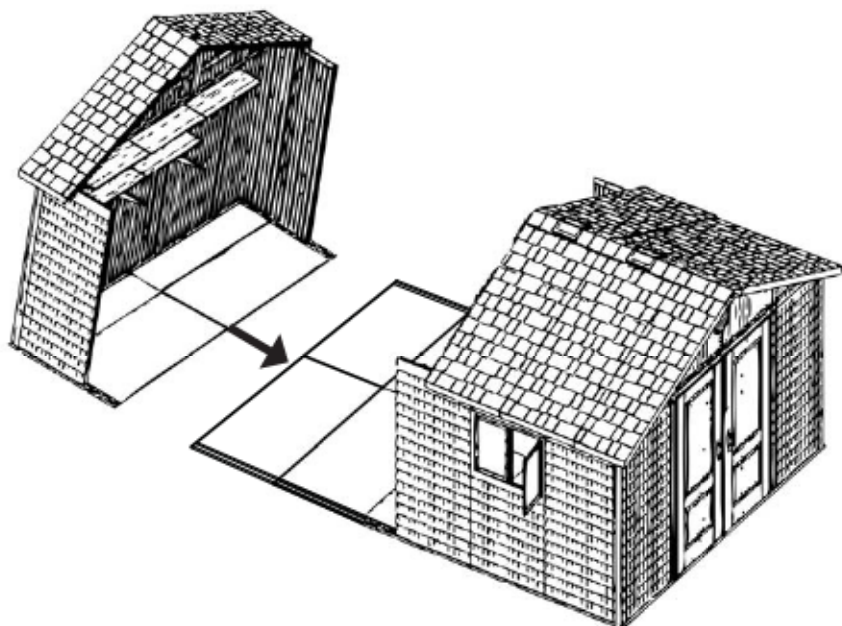

SEC 4 TRUSS ASSEMBLY

HARDWARE REQUIRED

Hardware shown at actual size

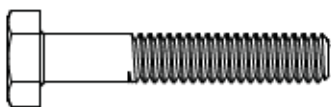

AAK (x20)
1/4" x 1 1/2" Hex Bolt



ADJ (x20)
1/4" Cap Nut

HARDWARE BAG REQUIRED: BGV (x2)

Hardware shown at 50% of actual size

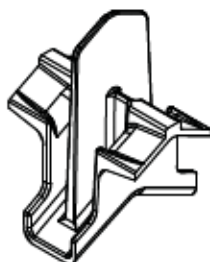

AIP (x2)
Truss Gutter Connector



AHT (x4)
Floor Bracket

METAL PARTS REQUIRED

Parts shown at 8% of actual size



71 11/16"

AFH (x4)
Truss Gutter Channel

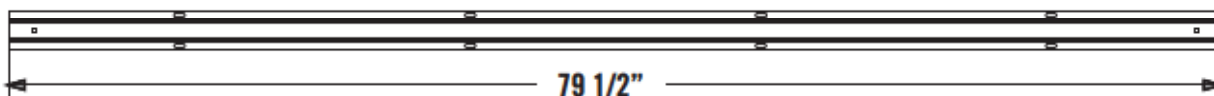
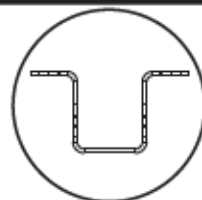

79 1/2"

AFG (x2)
Truss Brace Channel

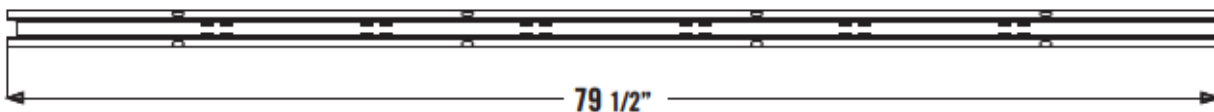

79 1/2"

AFQ (x4)
Wall/Shelf Support Channel

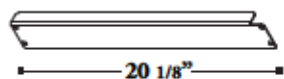
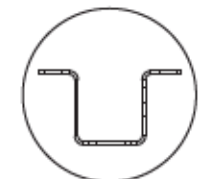

20 1/8"

AFP (x4)
Truss Support Strip

TOOLS REQUIRED



7/16" Wrench (x2)



Safety Glasses



TOOLS AND HARDWARE REQUIRED FOR THIS PAGE

SEC 4

7/16" (x2)

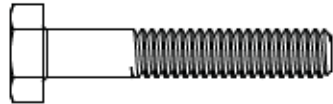

AAK (x12)



ADJ (x12)

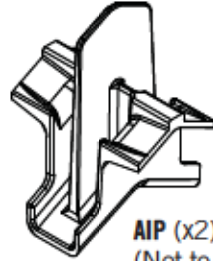

AIP (x2)
(Not to scale)



SEC

4.1

TRUSS ASSEMBLY

Fit two **Truss Support Strips (AFP)** together. Bolt **Truss Support Strips**, **Truss Gutter Connector (AIP)**, and two **Truss Gutter Channels (AFH)** as shown using the required hardware.

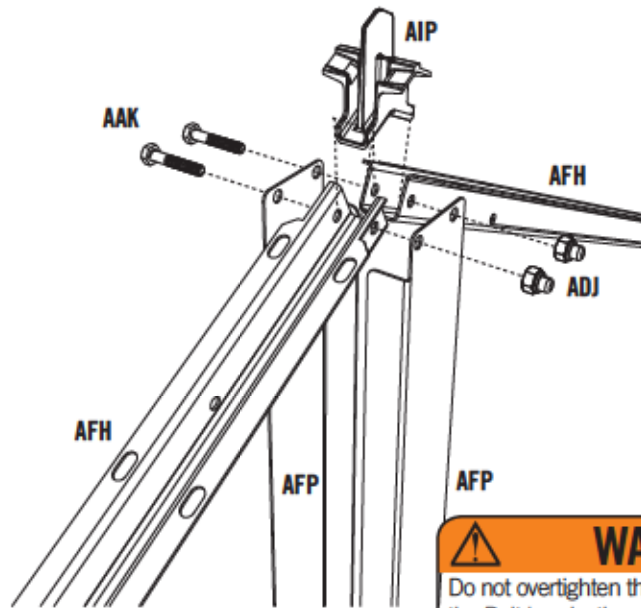
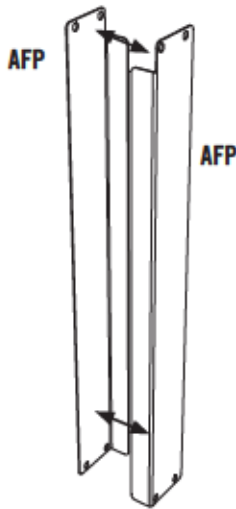

Note: Only finger tighten hardware.



WARNING

Do not overtighten the Cap Nut. If the end of the Bolt breaks through the plastic cap, call our Customer Service Department. Exposed threads on the end of the Bolt may cause serious injuries.

SEC

4.2

Attach **Truss Support Strips (AFP)** to the center of a **Truss Brace Channel (AFG)** (Truss Support Strips fit inside the Truss Brace Channel). Attach each end of the Truss Brace Channel to the **Truss Gutter Channels (AFH)** using the required hardware. Tighten all hardware.

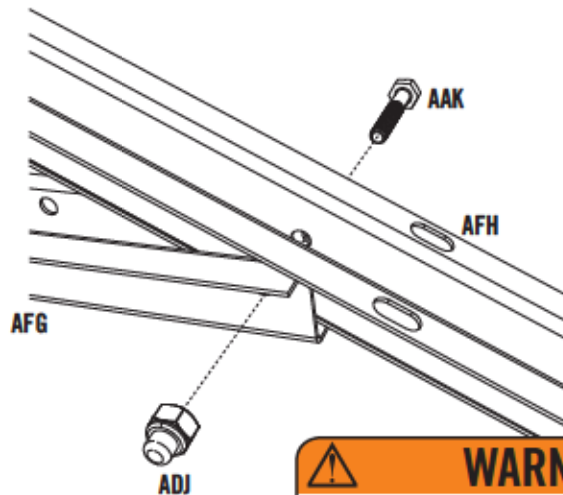
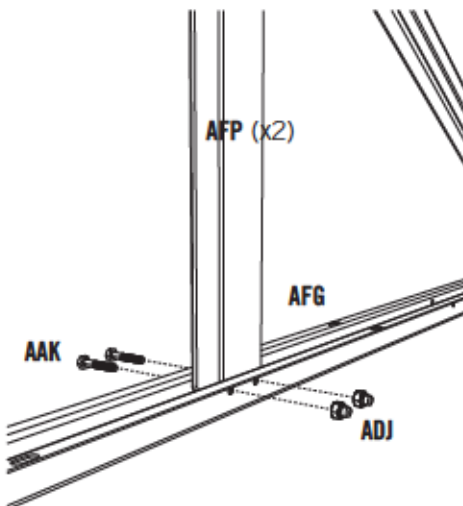

WARNING

Do not overtighten the Cap Nut.



TOOLS AND HARDWARE REQUIRED FOR THIS PAGE

SEC 4



7/16" (x2)

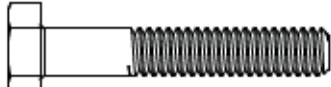

AAK (x4)



ADJ (x4)



SEC

4.3

Attach Truss Assembly to two **Wall Support Channels (AFQ)** using **1/4" x 1 1/2" Hex Bolts (AAK)** and **1/4" Cap Nuts (ADJ)**. Do not completely tighten the Cap Nut until after Truss is secured to the Wall.

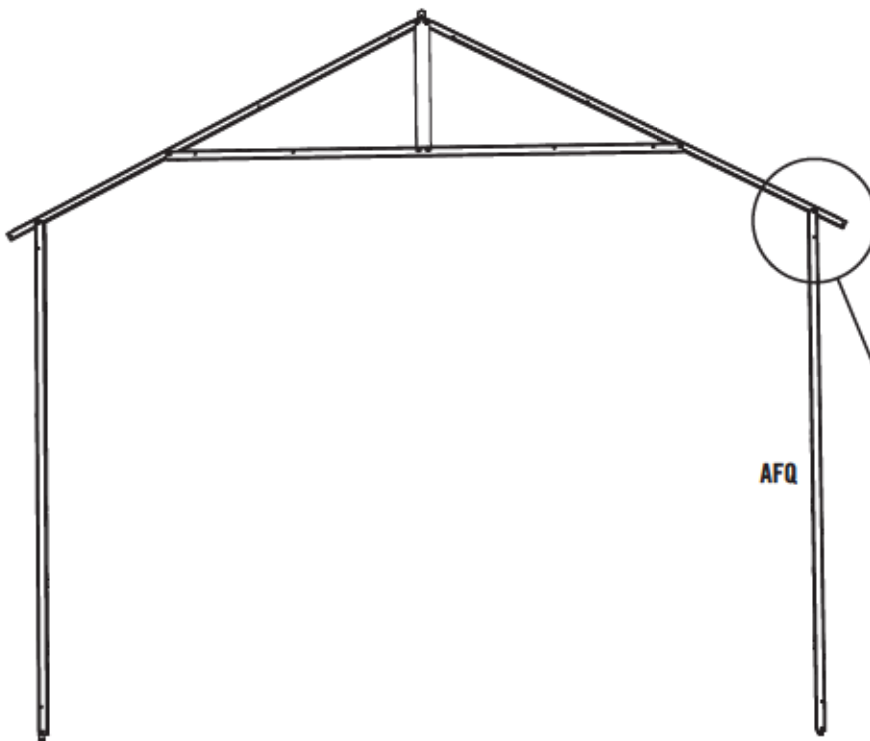

AFQ

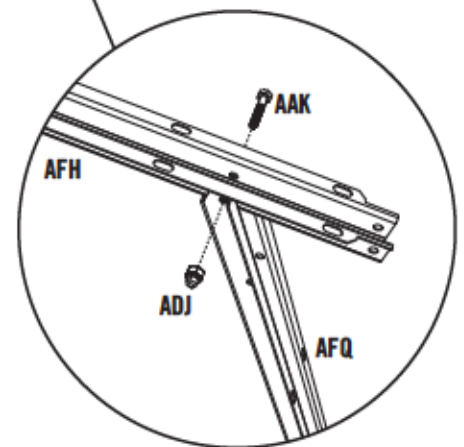

Note: Only finger tighten hardware.



WARNING

Do not overtighten the Cap Nut.



TOOLS AND HARDWARE REQUIRED FOR THIS PAGE

SEC



7/16" (x2)

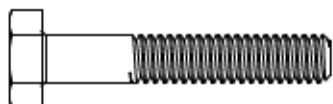

AAK (x4)



ADJ (x4)



AHT (x4)
(Not to scale)



SEC

4.4

Attach one **Floor Bracket (AHT)** to the bottom of each Wall/Shelf Support Channel using the required hardware. Tighten all hardware. **Repeat this section for all Trusses.** You need only do this step if you plan to anchor your Shed. See the "Anchoring the Shed" step at the end of this Owner's Manual.

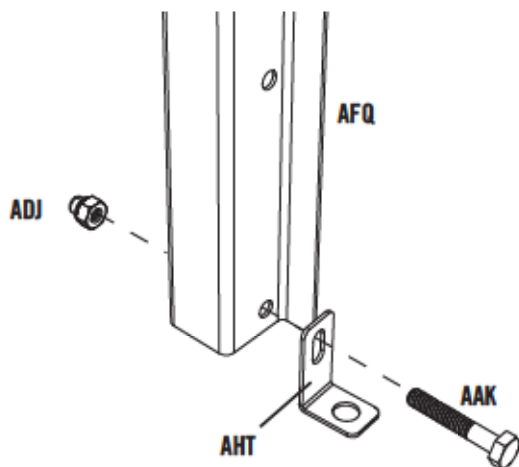

SEC 5 WINDOW ASSEMBLY & INSTALLATION

HARDWARE REQUIRED

HARDWARE BAG REQUIRED: BGU (x2)

Hardware shown at actual size



ADZ (x8)
1/4" x 5/8" Pan-Head Screw



ADW (x8)
#10 x 3/4" Pan-Head Screw



ADX (x44)
#10 x 1/2" Pan-Head Screw



AEE (x4)
#10 x 1/2" Flat Washer



ACF (x4)
#10 x 5/16" Pan-Head Screw



ACB (x8)
#10 x 1 1/4" Pan-Head Screw



ACD (x4)
#10 x 3/8" Flat-Head Screw



ADK (x4)
#10 Cap Nut

Hardware shown at 25% of actual size



AIE (x4)
Mounted Window Stay



AIN (x4)
Sliding Window Stay

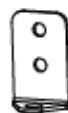

AIV (x4)
Window Stay Bracket



AIR (x8)
Window Hinge Tube

Hardware shown at 50% of actual size



AIU (x8)
Window Latch Bearing



AIT (x8)
Window Latch

PLASTIC PARTS REQUIRED

Parts shown at 8% of actual size

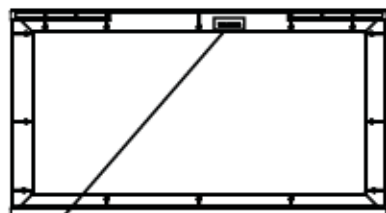

1004595
AHG (x4)
Window Frame

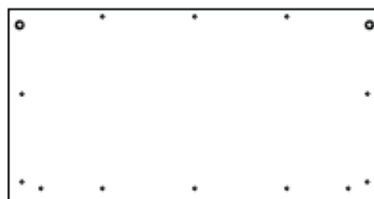

AHF (x4)
Window

TOOLS REQUIRED

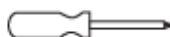

Phillips Screwdriver



Safety Glasses



TOOLS AND HARDWARE REQUIRED FOR THIS PAGE

SEC 5



AIR (x4)
(Not to scale)



SEC

5.1

Slide **Window Hinge Tubes (AIR)** into the upper and lower hinge holes and fit a **Window Frame (AHG)** over the Hinge Tubes.

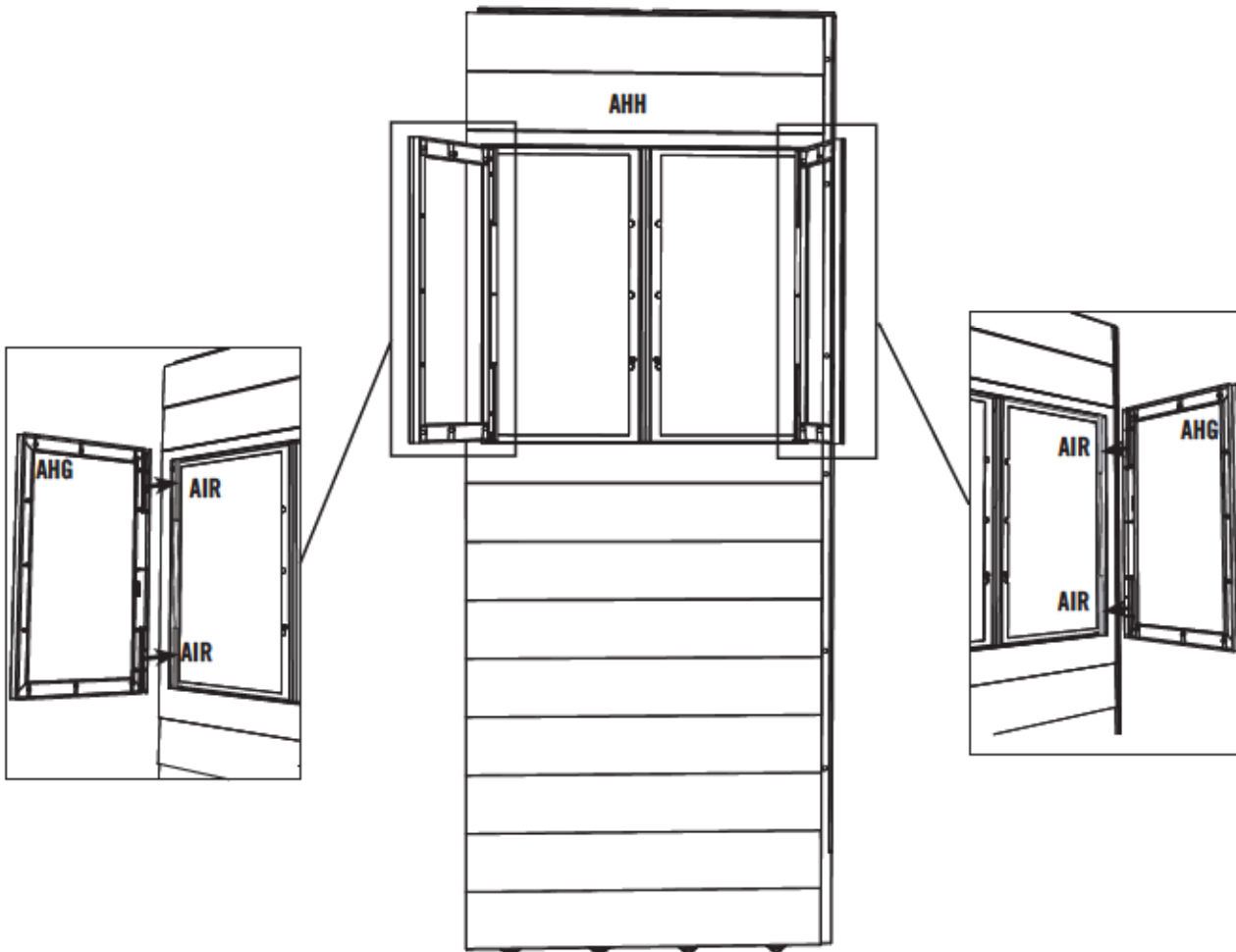



TOOLS AND HARDWARE REQUIRED FOR THIS PAGE

SEC 5

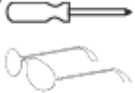

ADX (x20)



SEC

5.3

Place a **Window (AHF)** onto the Window Frame. Fasten the Window to the Frame with **#10 x 1/2" Pan Head Screws (ADX)** in the locations shown.



Note: Remove plastic film from both sides of window before installing.

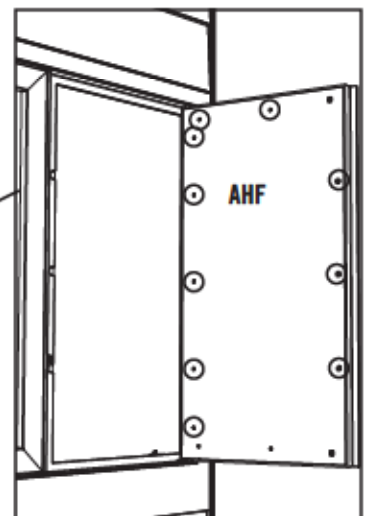
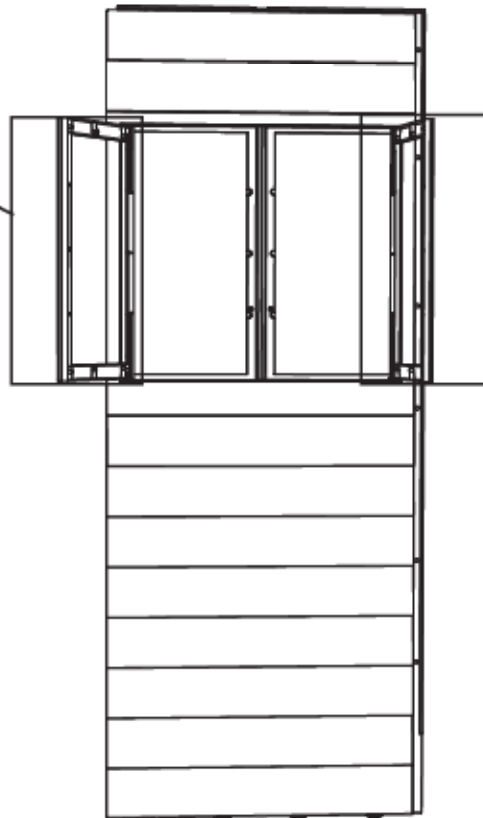
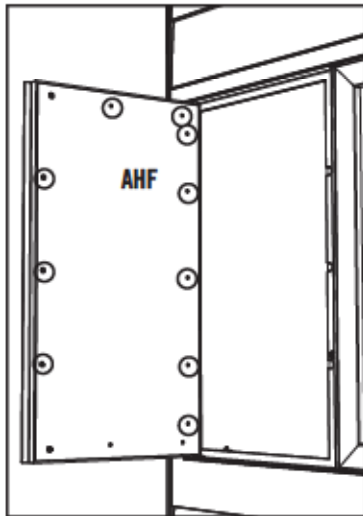
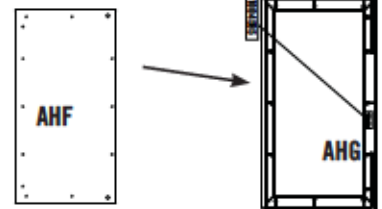

Note: Insert Screws into the holes with circles.



TOOLS AND HARDWARE REQUIRED FOR THIS PAGE

SEC 5

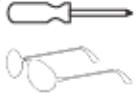

AIV (x2)
(Not to scale)

AIE (x2)
(Not to scale)



ADW (x4)

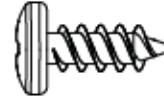

ADZ (x4)



SEC

5.4

Attach **Window Stay Brackets (AIV)** to the inside of the **Window Wall Panel (AHH)**.

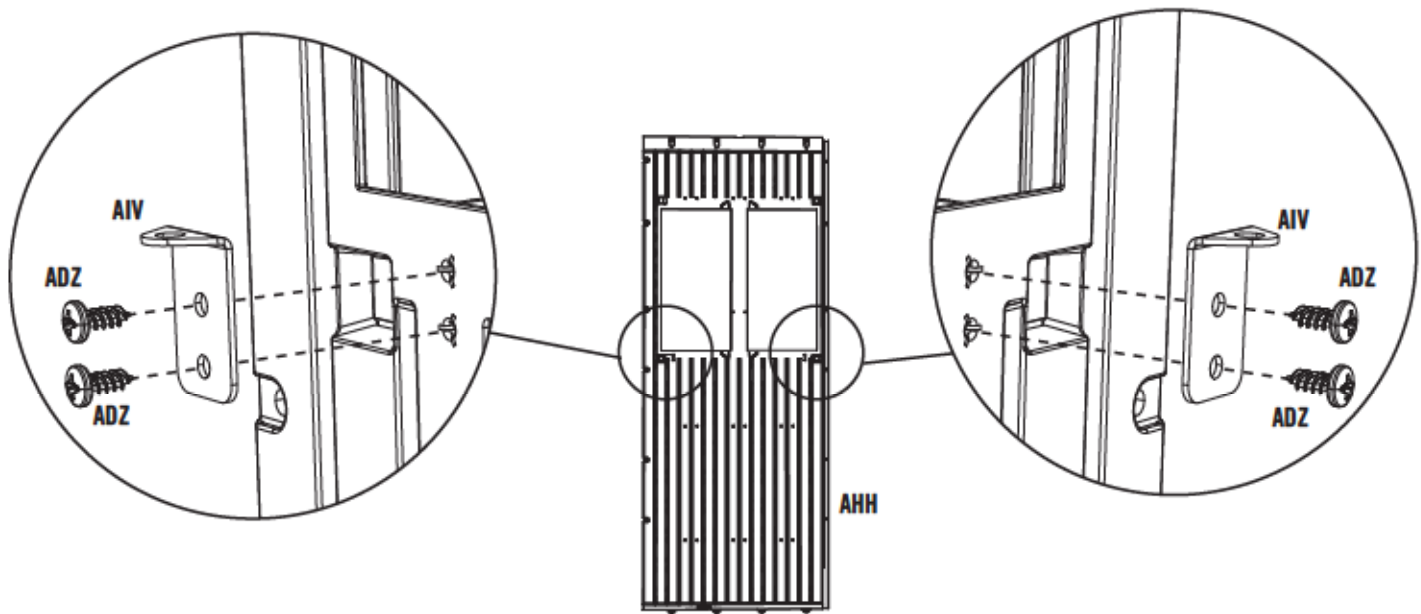

SEC

5.5

Attach a **Mounted Window Stay (AIE)** to the bottom of the **Window Frame**.

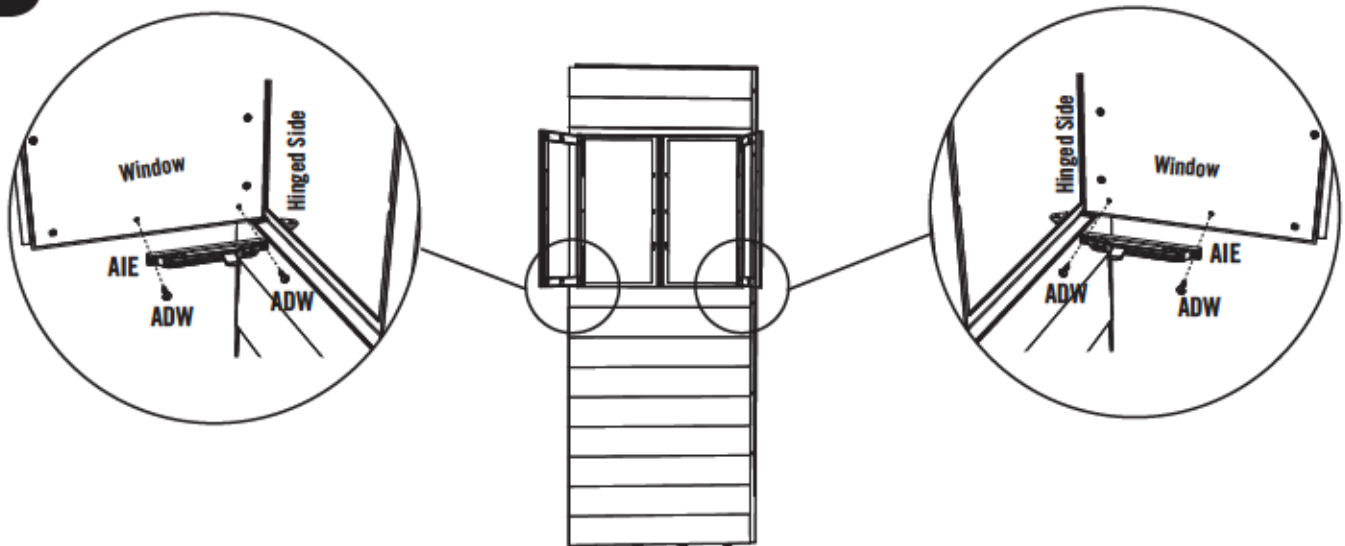



TOOLS AND HARDWARE REQUIRED FOR THIS PAGE

SEC 5

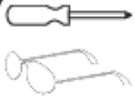

AEE (x2)



ADX (x2)



AIN (x2)
(Not to scale)



ACF (x2)



SEC

5.6

Fit a **Sliding Window Stay (AIN)** into the **Mounted Window Stay**. To add rigidity to the nub of the Sliding Window Stays, insert **#10 x 1/2" Pan-Head Screws (ADX)** as shown.

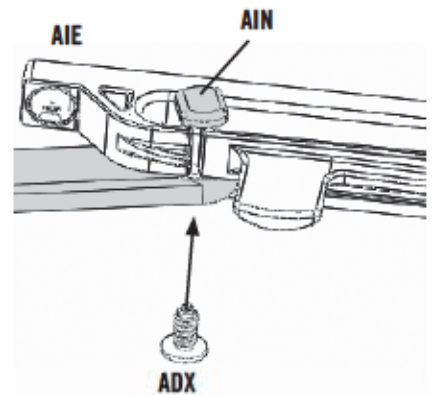
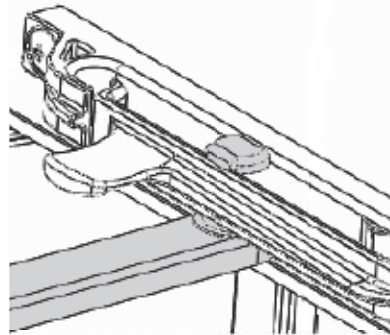
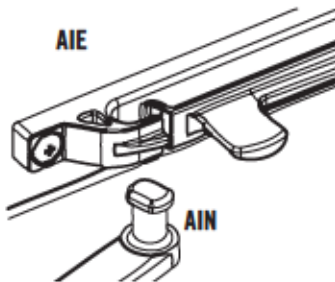

SEC

5.7

Attach a **Sliding Window Stay (AIN)** to the **Window Stay Bracket (AIV)** using the required hardware.

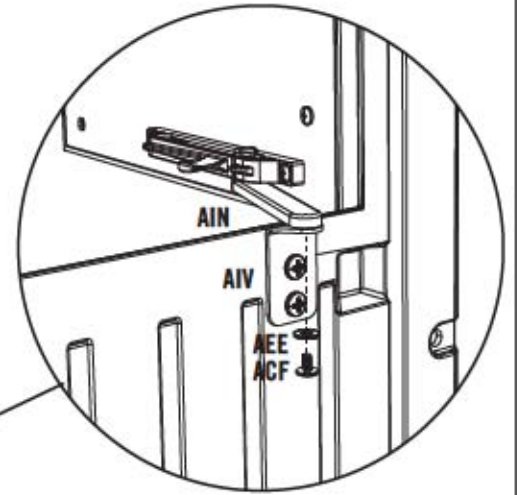
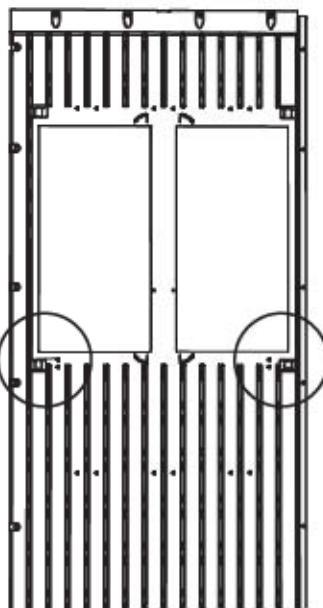
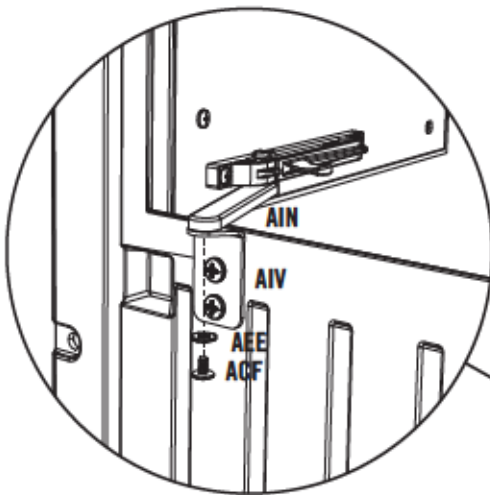



TOOLS AND HARDWARE REQUIRED FOR THIS PAGE

SEC 5

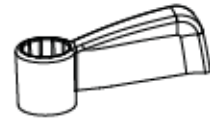
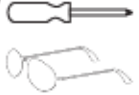

AIT (x4)
(Not to scale)



AIU (x4)
(Not to scale)

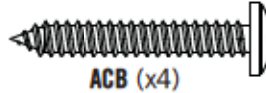

ACB (x4)



SEC

5.8

Fit a **Window Latch Bearing (AIU)** into a **Window Latch (AIT)**. Attach the Window Latch to the upper latch location with a **#10 x 1 1/4" Pan-Head Screw (ACB)**. Repeat for other Window Latches.



Note: Ensure notch in Window Latch Bearing fits over the plastic ridge in the Window Frame.

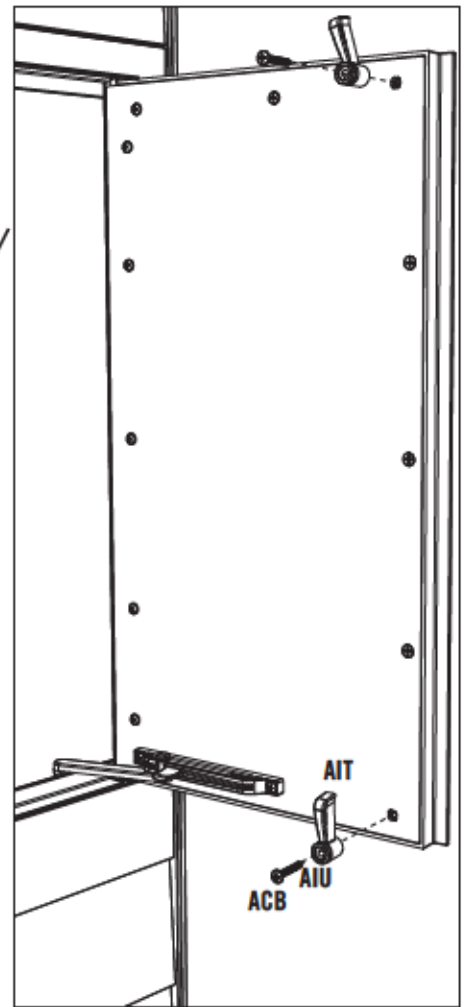
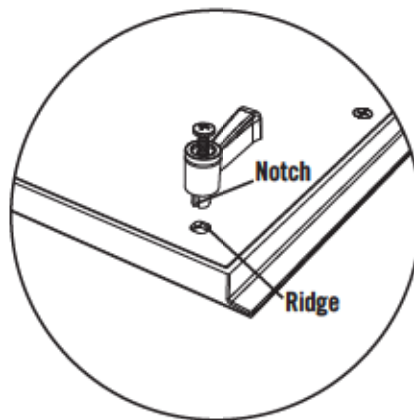
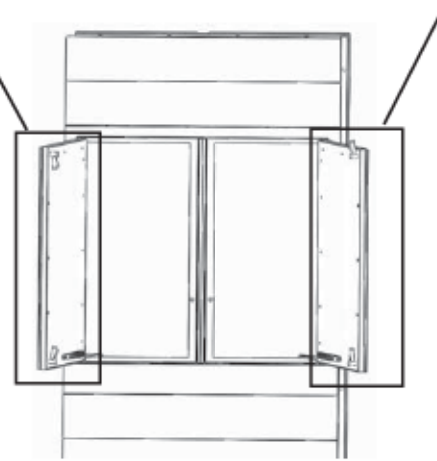
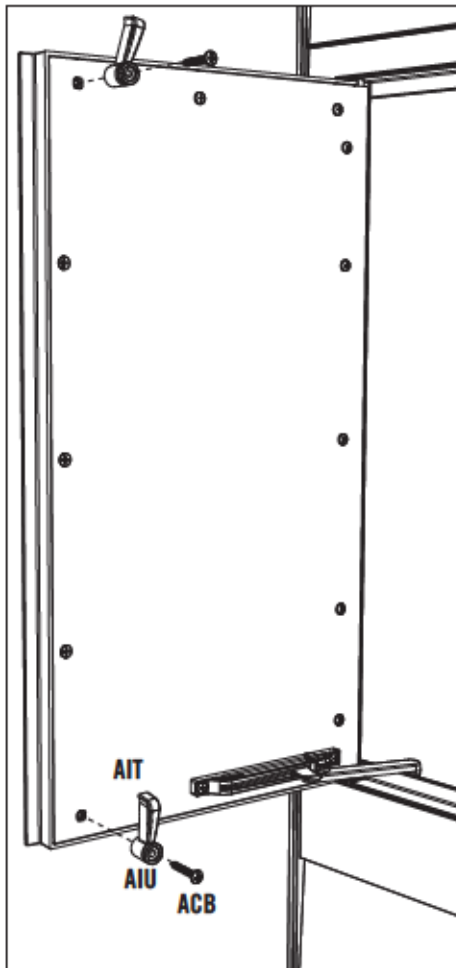

SEC 6 WALL & ROOF INSTALLATION

HARDWARE REQUIRED

HARDWARE BAG REQUIRED: BGT

Hardware shown at actual size (*unless otherwise indicated)



AJA (x8)*
Foam Cube

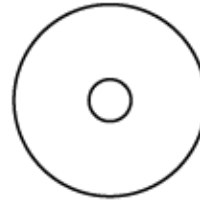

AED (x8)
#10 x 1" Fender Washer

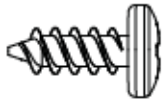

ADZ (x120)
1/4" x 5/8" Phillips Pan-Head Screw



ACJ (x8)
#10 x 5/8" Phillips Pan-Head Screw

METAL PARTS REQUIRED

Part shown at 8% of actual size

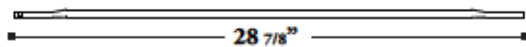

AFL (x12)
Roof Support Strip

PLASTIC PARTS REQUIRED

Parts shown at 4% of actual size

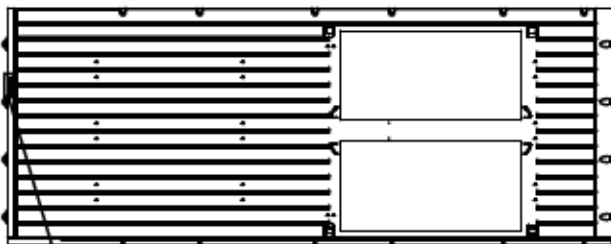

100XXXX

AHH (x2) Window Wall Panel Assembly (Assembled in Section 4)

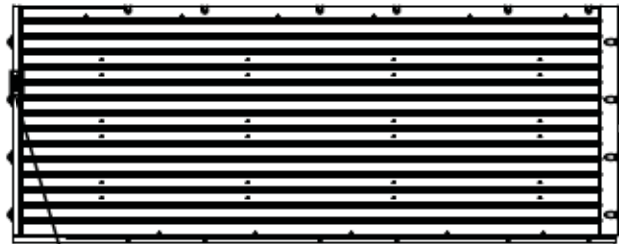

1000272

AHD (x2) Wall Panel

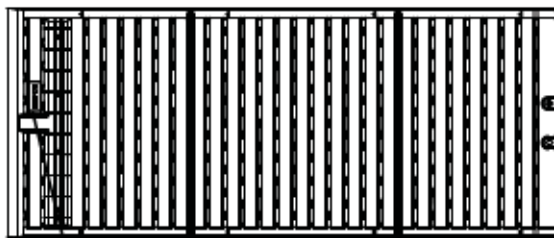

1000476

AGQ (x4) Center Roof Panel

Part shown at 8% of actual size

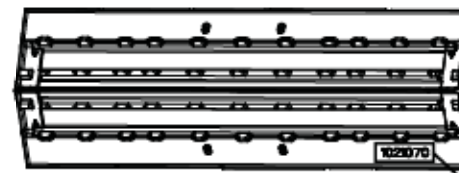

AFY (x2)
Center Roof Cap

1021070

TOOLS REQUIRED



Phillips Screwdriver



7/16" Wrench (x2)



Safety Glasses



TOOLS AND HARDWARE REQUIRED FOR THIS PAGE



ADZ (x24)

SEC 6



SEC

6.1

Insert a Wall Panel you removed previously as well as the **Wall Panel (AHD)** and **Window Wall Panel (AHH)** provided with this kit. You can insert the Panels in any of the available locations. Use the 1/4" x 5/8" Phillips Pan-Head Screws you removed previously as well as the 1/4" x 5/8" Phillips Pan-Head Screws (ADZ) provided with this kit to secure the Panels together. **Repeat this step for the opposite side of the shed.**

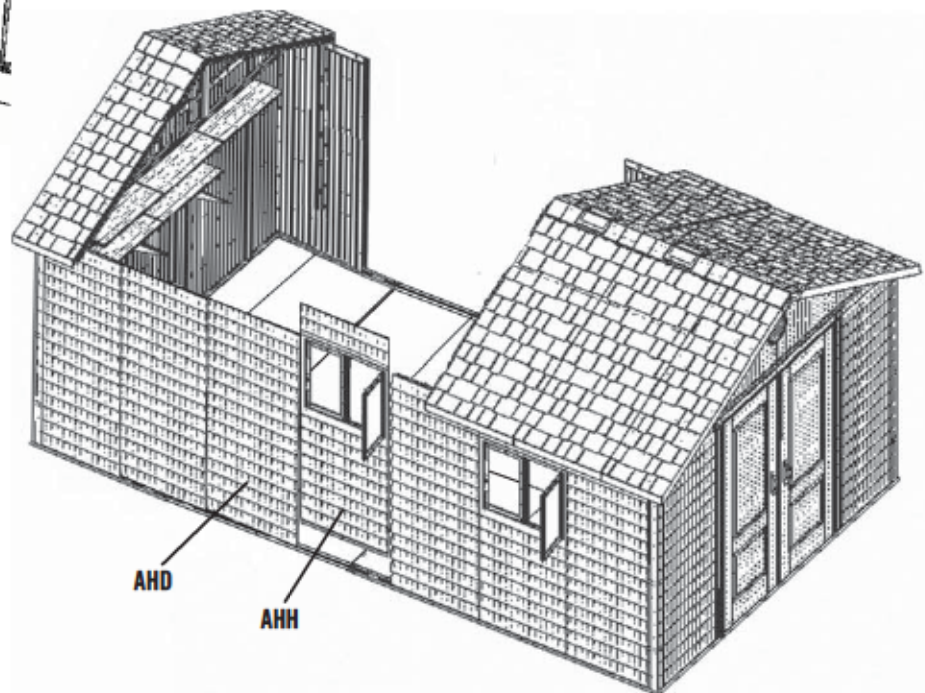
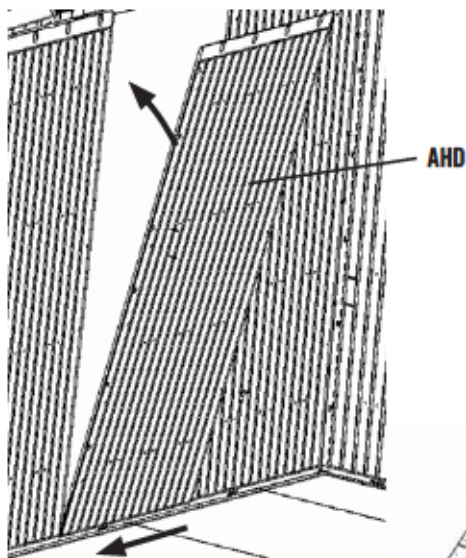



TOOLS AND HARDWARE REQUIRED FOR THIS PAGE



SEC 6



SEC

6.2

Connect the Truss Assembly you removed previously as well as the two Truss Assemblies you built using this kit to the center of each Wall Panel and Window Wall Panel with $1/4" \times 5/8"$ Phillips Pan-Head Screws (ADZ).

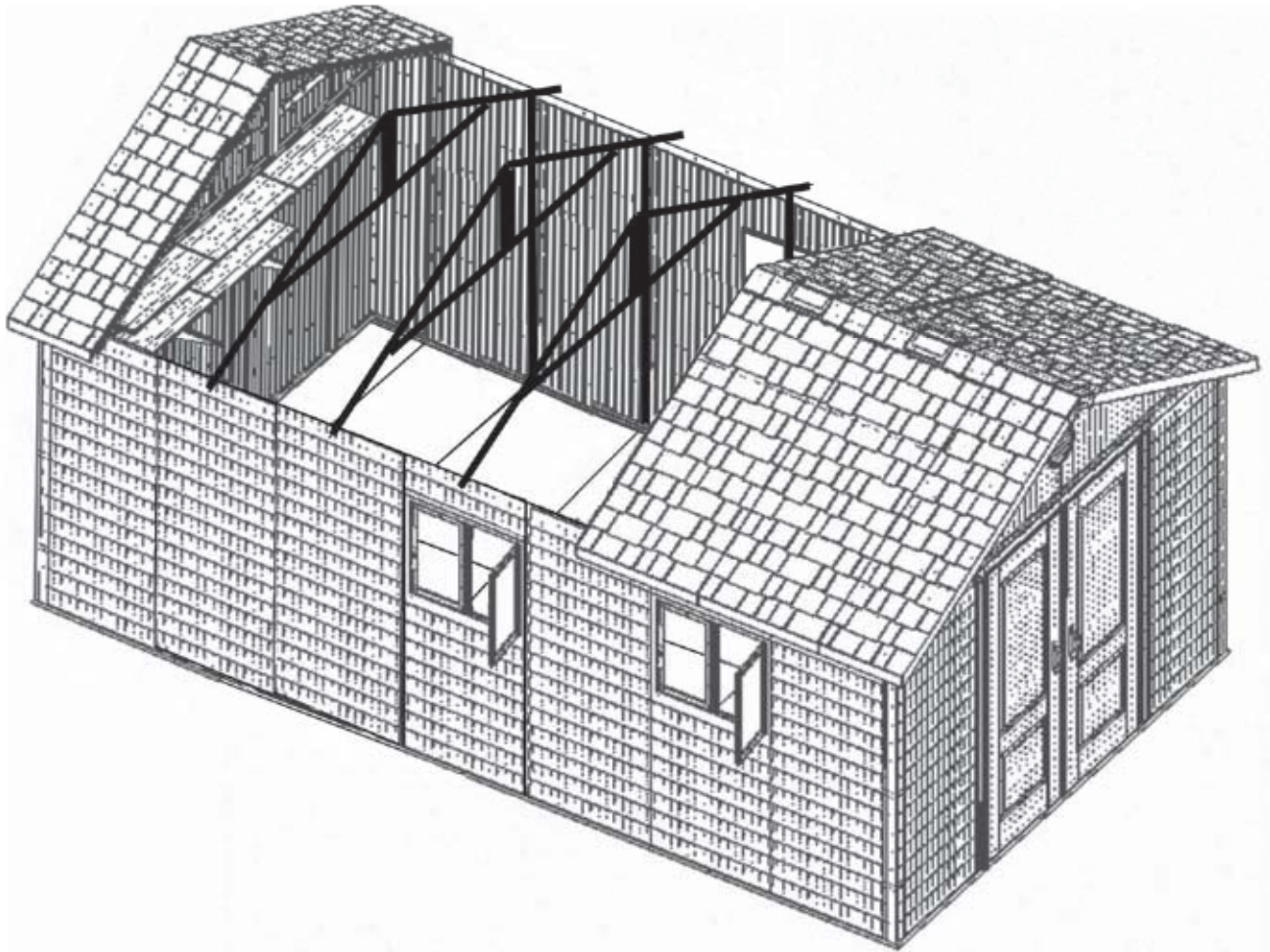



TOOLS AND HARDWARE REQUIRED FOR THIS PAGE

SEC 6

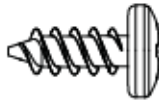
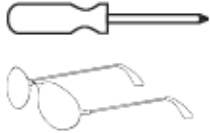

ADZ (x48)



ACJ (x8)

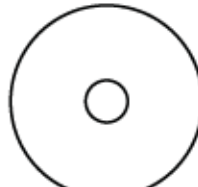

AED (x8)



SEC

6.4

Connect the Center Roof Panels, Roof Support Strips, and Center Roof Caps you removed previously as well as the **Center Roof Panels (AGQ)**, **Roof Support Strips (AFL)**, and **Center Roof Caps (AFY)** provided with this kit using **1/4" x 5/8" Phillips Pan-Head Screws (ADZ)**.

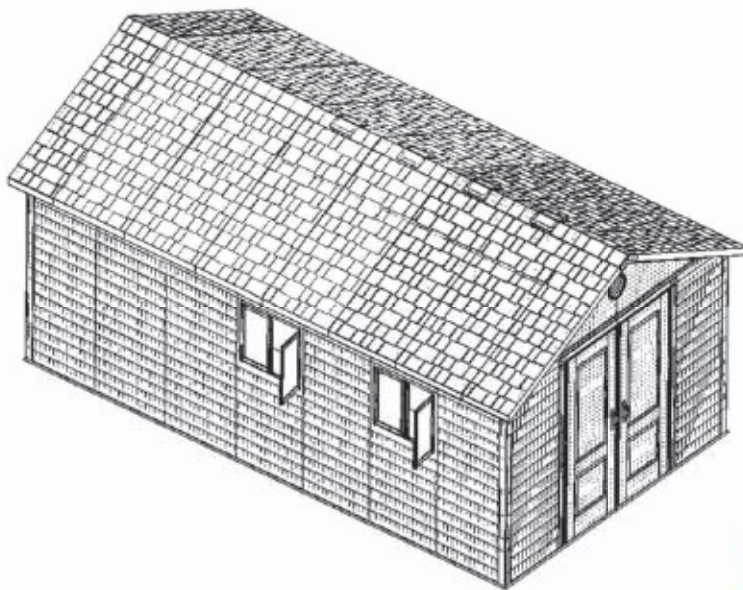

AFL



28 7/8"

The hole at the end of the Roof Support Strip is for manufacturing purposes only.



! Note: Only use a hand screwdriver on this step.

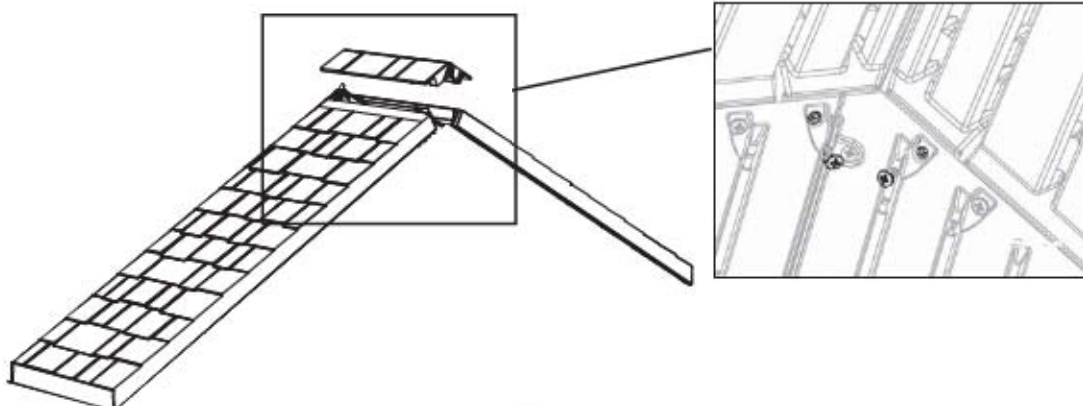



TOOLS AND HARDWARE REQUIRED FOR THIS PAGE

SEC 6

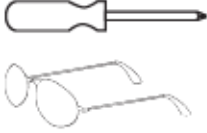

AJA (x8)

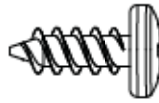

ADZ (x8)



SEC

6.5

Connect the Truss Gutter Channels to the underside of the bottom of the Roof Panels using $1/4" \times 5/8"$ Phillips Pan-Head Screws (ADZ). When finished, insert Foam Cubes (AJA) inside the Truss Gutter Channels at the locations shown. If you plan on anchoring your Shed, follow the instructions that came with your original owner's manual.

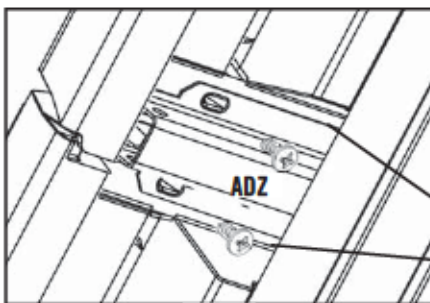
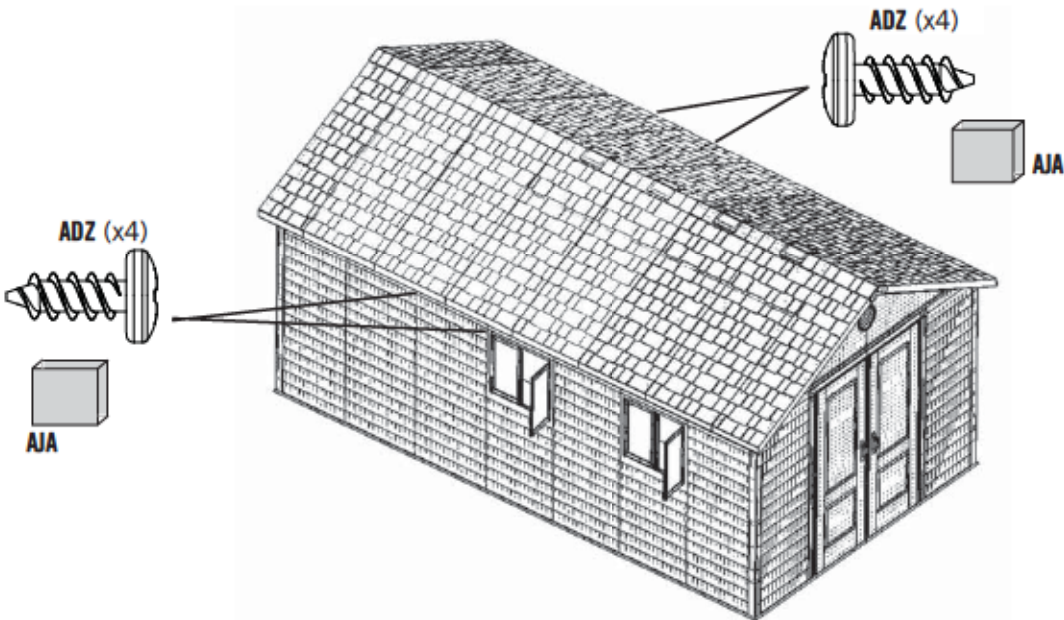

Fig. 1

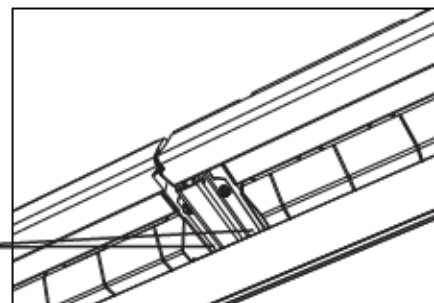

Fig. 2

LIFETIME OUTDOOR SHED EQUIPMENT

10-YEAR LIMITED FACTORY WARRANTY

THE MANUFACTURER RESERVES THE RIGHT TO MAKE SUBSTITUTIONS TO WARRANTY CLAIMS IF PARTS ARE UNAVAILABLE OR OBSOLETE.

1. Lifetime outdoor sheds are warranted to the original purchaser to be free from defects in material or workmanship for a period of ten years from the date of original retail purchase. The word "defects" is defined as imperfections that impair the use of the product. Defects resulting from misuse, abuse or negligence will void this warranty. This warranty does not cover defects due to improper installation, alteration or accident. This warranty does not cover damage caused by vandalism, rusting, "acts of nature" or any other event beyond the control of the manufacturer.
2. This warranty is nontransferable and is expressly limited to the repair or replacement of defective product. If the product is defective within the terms of this warranty, Lifetime Products, Inc. will repair or replace defective parts at no cost to the purchaser. Shipping charges to and from the factory are not covered and are the responsibility of the purchaser. Labor charges and related expenses for removal, installation or replacement of the shed or its components are not covered under this warranty.
3. This warranty does not cover scratching or scuffing of the product that may result from normal usage. In addition, defects resulting from intentional damage, negligence, unreasonable use or hanging from the truss will void this warranty.
4. Liability for incidental or consequential damages is excluded to the extent permitted by law. While every attempt is made to embody the highest degree of safety in all equipment, freedom from injury cannot be guaranteed. The user assumes all risk of injury resulting from the use of this product. All merchandise is sold on this condition, and no representative of the company may waive or change this policy.
5. This product is not intended for institutional or commercial use; Lifetime Products, Inc. does not assume any liability for such use. Institutional or commercial use will void the warranty.
6. This warranty is expressly in lieu of all other warranties, expressed or implied, including warranties of merchantability or fitness for use to extent permitted by Federal and state law. Neither Lifetime Products, Inc., nor any representative assumes any other liability in connection with this product. This warranty gives you specific legal rights, and you may also have other rights which vary from state to state.

PLEASE INCLUDE YOUR DATED SALES RECEIPT AND PHOTOGRAPHS OF DAMAGED PARTS.

REPORT PRODUCT DEFECTS IN WRITING TO:

Lifetime Products, Inc., PO Box 160010 Clearfield, UT 84016-0010
or call 1-800-225-3865 M-F 7 a.m. to 5 p.m. MST.

REGISTER YOUR PRODUCT FOR QUICKER CUSTOMER SERVICE.

Visit www.lifetime.com or call 1-800-225-3865 to register your product today.

FOR INTERNATIONAL WARRANTY CLAIMS:

All warranty claims must be accompanied by a sales receipt. Report all warranty claims in writing to your regional sales support representative. Please include your dated sales receipt and photographs of damaged parts.

To identify the representative for your region — Please visit: www.lifetime.com/international



www.lifetime.com

ENHANCE YOUR LIFETIME® PURCHASE BY ADDING ACCESSORIES OR OTHER GREAT PRODUCTS

To purchase accessories or other Lifetime Products, visit us at:

www.lifetime.com

Or call: 1-800-424-3865

