



TABLES & CHAIRS

MODEL N° 2871

OWNER'S MANUAL

Keep this Identification Number in case you must contact our Customer Service Department.

REGISTER YOUR LIFETIME PRODUCT TODAY!

There are benefits to registering your Lifetime product. With our new online product registration form, it's fast and easy! Register with us at www.lifetime.com and enjoy these great benefits:

- Receive exclusive money-saving offers from BuyLifetime.com, our online store, as well as NEW product notifications and special closeout promotions!
- In the unlikely event of a product recall or safety modification, we will notify you immediately and directly.
- Registering your product guarantees you immediate warranty service. If you do not register your product, your warranty rights will not be diminished. But you will need to provide a sales receipt to verify your product purchase date before warranty service will be provided.

LIFETIME'S PROMISE TO YOU:

Maintaining your privacy is our long-standing policy at Lifetime. And you can rest assured that Lifetime will not sell or provide your personal data to other third parties, or allow them to use your personal data for their own purposes.

We invite you to read our privacy policy at www.lifetime.com

REGISTER today!

Save this instruction in the event that the manufacturer has to be contacted for replacement parts.

****U.S. and Canada customers ONLY****

IF ASSISTANCE IS NEEDED,

DO NOT CONTACT THE STORE!

CALL OUR CUSTOMER SERVICE DEPARTMENT at 1 (800) 225-3865

HOURS: 7:00 a.m. to 5:00 p.m. Monday through Friday (Mountain Standard Time)

Call, or visit our Web site for Saturday hours

For customers outside the U.S. or Canada, please contact the store for assistance.



SAFETY INSTRUCTIONS



FAILURE TO FOLLOW THESE WARNINGS MAY RESULT IN SERIOUS INJURY OR PROPERTY DAMAGE AND WILL VOID WARRANTY.

To ensure safety, do not attempt to assemble this system without following the instructions carefully. Check entire box and inside all packing material for parts and/or additional instruction material. Before beginning assembly, read the instructions and identify parts using the hardware identifier and parts list in this document. Proper and complete assembly, use and supervision are essential for proper orientation and to reduce the risk of accident or injury. A high probability of serious injury exists if this system is not installed, maintained, and/or operated properly.

- Two capable adults are recommended for assembly.
- Follow any and all warnings and cautions carefully.
- Assemble on level ground.
- Check all nuts and screws for tightness before and during the usage season.

Most injuries are caused by misuse and/or not following instructions. Use caution when using this system.

STOP!

BEFORE BEGINNING ASSEMBLY

STOP!

Keep the hardware bags and their contents separate. If any parts are missing, call our Customer Service Department.

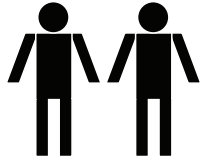

****TWO ADULTS REQUIRED TO COMPLETE ASSEMBLY****



TOOLS REQUIRED FOR ASSEMBLY (NOT INCLUDED)

Phillips Screwdriver

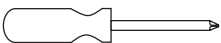

(1)

5/16" Wrench



(1)

7/16" Wrench

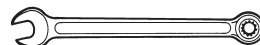

(1)

Safety Glasses

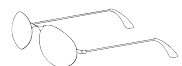

(1 pair for each person)

ASSEMBLY GUIDES

Refer to the following areas throughout the instructions to assist in the assembly process:

This area is located at the top, left-hand corner of the page and indicates which tools and hardware are needed to complete the assembly steps on a page.



TOOLS AND HARDWARE REQUIRED FOR THIS PAGE



This area is located at the top, left-hand corner of the page and shows an image of the product with shaded parts indicating which section is being assembled.

SEC #



This area is usually located in the bottom, left-hand corner of a step and indicates that special attention is needed to perform a particular part of a step.



Note:



These areas are usually located in the bottom, right-hand corner of a step and indicate that damage to the product or serious injury may occur if the caution or warning is not heeded.



CAUTION



WARNING



PARTS & HARDWARE LIST

ID	DESCRIPTION	QTY	✓	ID	DESCRIPTION	QTY	✓
BAS	Right Leg	1	<input type="checkbox"/>	BCI	FRAME ASSEMBLY HARDWARE BAG		
BAT	Left Leg	1	<input type="checkbox"/>	BCE	M5 x .8 mm x 25 mm Pan-Head Screw	8	<input type="checkbox"/>
BAU	Leg Cross Support	2	<input type="checkbox"/>	BCF	M5 x .8 mm x 33 mm Pan-Head Screw	2	<input type="checkbox"/>
BAV	Bearing Arm	4	<input type="checkbox"/>	BCG	M5 x .8 mm x 57 mm Pan-Head Screw	4	<input type="checkbox"/>
BAW	Right Arm	1	<input type="checkbox"/>	BAN	M5 x .8 mm Nylock Nut	14	<input type="checkbox"/>
BAX	Left Arm	1	<input type="checkbox"/>	BAM	1/4 Nylock Cap Nut	4	<input type="checkbox"/>
BAY	Back Cross Support	1	<input type="checkbox"/>	BCJ	BACK & SEAT ASSEMBLY HARDWARE BAG		
BAZ	Seat Cross Support	1	<input type="checkbox"/>	BAM	1/4 Nylock Cap Nut	4	<input type="checkbox"/>
BBA	Bench Back	1	<input type="checkbox"/>	BAL	Plastic Screw	9	<input type="checkbox"/>
BBB	Bench Seat	1	<input type="checkbox"/>	BAO	5 mm Allen Wrench	1	<input type="checkbox"/>

HARDWARE IDENTIFIER

FRAME ASSEMBLY HARDWARE BAG [BCI]

Parts shown are actual size (unless otherwise noted)

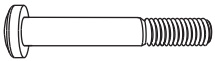

BCE (x8)
M5 x .8 mm x 25 mm Pan-Head Screw

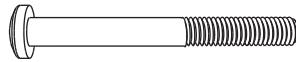

BCF (x2)
M5 x .8 mm x 33 mm Pan-Head Screw

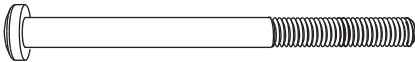

BCG (x4)
M5 x .8 mm x 57 mm Pan-Head Screw



BAN (x14)
M5 x .8 mm Nylock Nut



BAM (x4)
1/4" Nylock Cap Nut

BACK & SEAT ASSEMBLY HARDWARE BAG [BCJ]

Parts shown are actual size (unless otherwise noted)



BAM (x4)
1/4"-20 Nylock Cap Nut

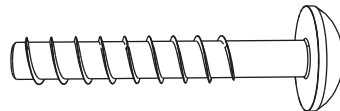

BAL (x9)
Plastic Screw

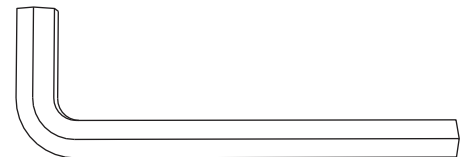

BAO (x1)
5 mm Allen Wrench (Included)

PARTS IDENTIFIER

GLIDER BENCH PARTS

Parts shown at same scale (unless otherwise noted)

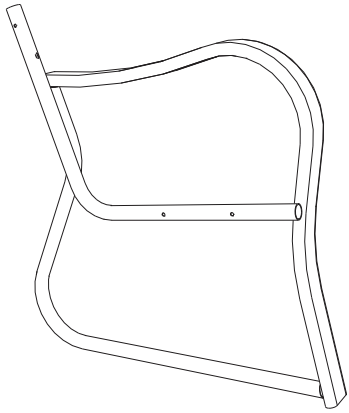

BAX (x1)
Left Arm

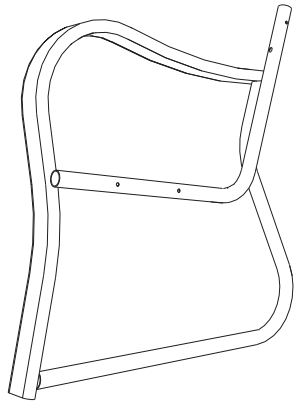

BAW (x1)
Right Arm

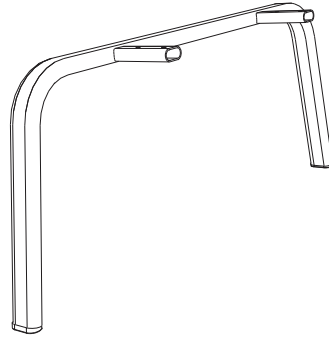

BAT (x1)
Left Leg

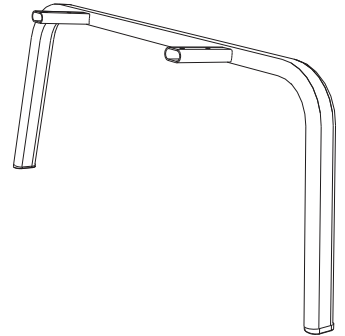

BAS (x1)
Right Leg

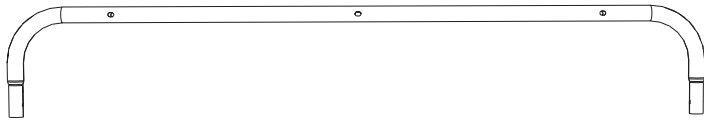

BAY (x1)
Back Cross Support

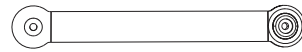

BAV (x4)
Bearing Arm

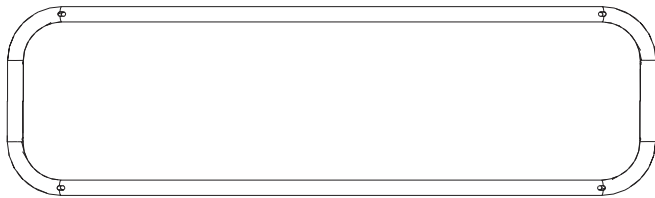

BAZ (x1)
Seat Cross Support



BAU (x2)
Leg Cross Support

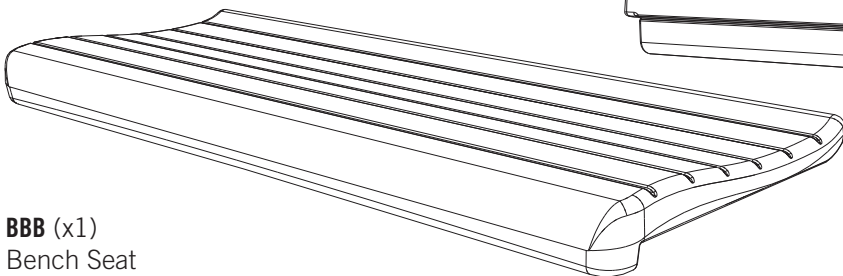

BBB (x1)
Bench Seat

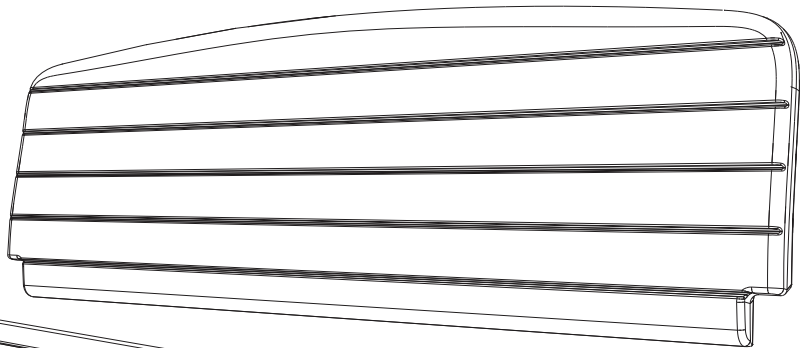

BBA (x1)
Bench Back

SEC 1 BENCH FRAME ASSEMBLY

HARDWARE USED

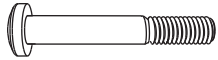

BCE (x8)
M5 x .8 mm x 25 mm Pan-Head Screw

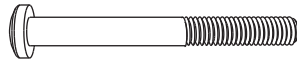

BCF (x2)
M5 x .8 mm x 33 mm Pan-Head Screw



BAN (x14)
M5 x .8 mm Nylock Nut



BAM (x4)
1/4" Nylock Cap Nut



BCG (x4)
M5 x .8 x 57 mm Pan-Head Screw

METAL PARTS USED

Parts Shown at Same Scale

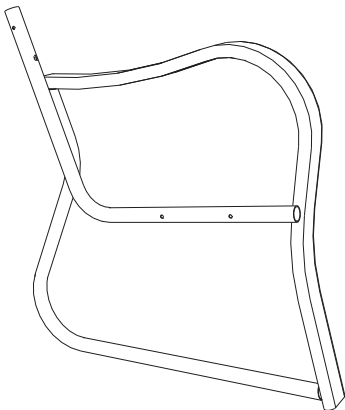

BAX (x1)
Left Arm Weldment

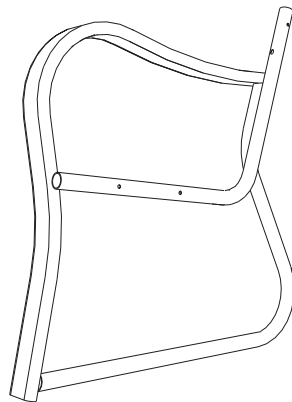

BAW (x1)
Right Arm Weldment

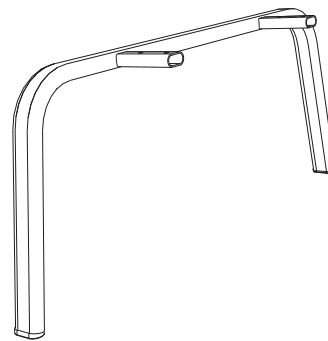

BAT (x1)
Left Leg Assembly



BAS (x1)
Right Leg Assembly

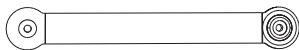

BAV (x4)
Bearing Arm

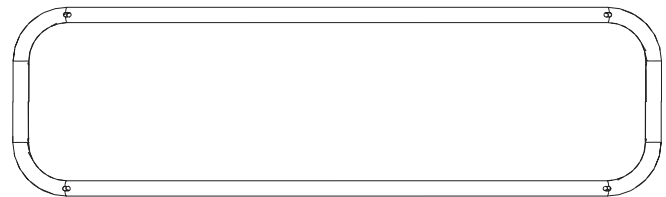

BAZ (x1)
Seat Cross Support

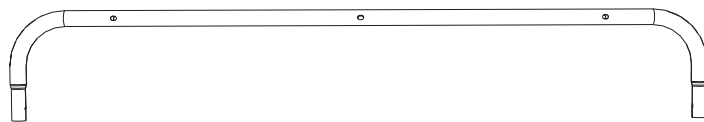

BAY (x1)
Back Cross Support



BAU (x2)
Leg Cross Support

PLASTIC PARTS USED

NO PLASTIC PARTS REQUIRED FOR THIS SECTION

TOOLS USED (NOT INCLUDED)

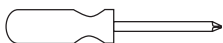

Phillips Screwdriver



5/16" Wrench



7/16" Wrench



Safety Glasses

1.



TOOLS AND HARDWARE REQUIRED FOR THIS PAGE

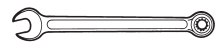
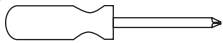

5/16"



7/16"

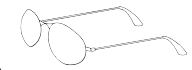

BCE (x8)



BAN (x10)

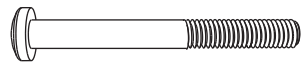

BCF (x2)



BAM (x4)

SEC 1

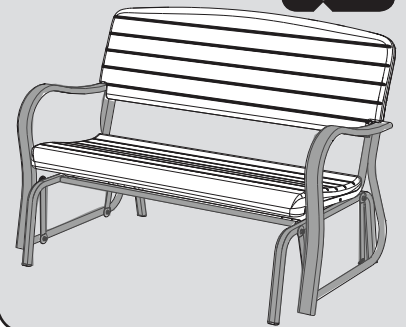

SEC

1.1

FRAME ASSEMBLY:

Attach the **Leg Cross Supports (BAU)** to the **Right and Left Legs (BAS and BAT)** using the hardware shown.

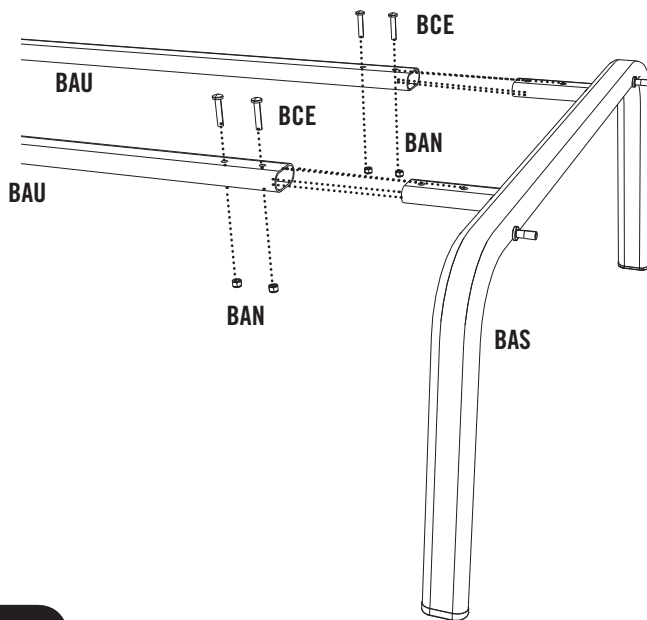

SEC

1.2

Orient the **Bearing Arms (BAV)** so they angle away from the Legs when attached. Connect Bearing Arms using the hardware shown. Complete for both Legs.

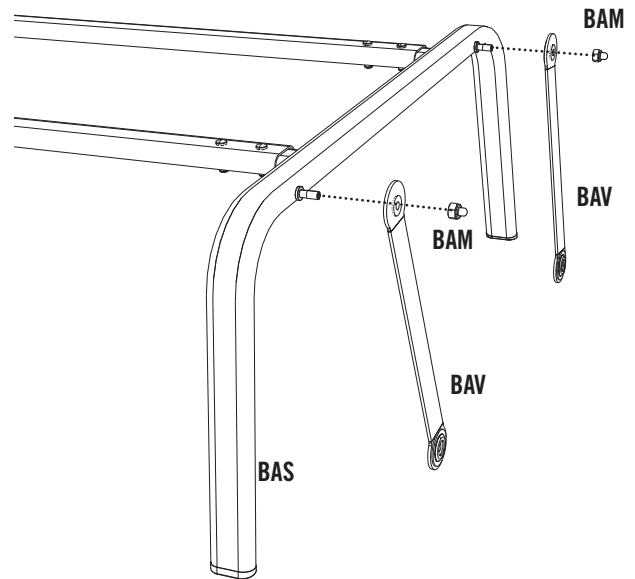

SEC

1.3

Connect the **Back Cross Support (BAY)** to the **Right and Left Arms (BAW and BAX)** using the hardware shown.

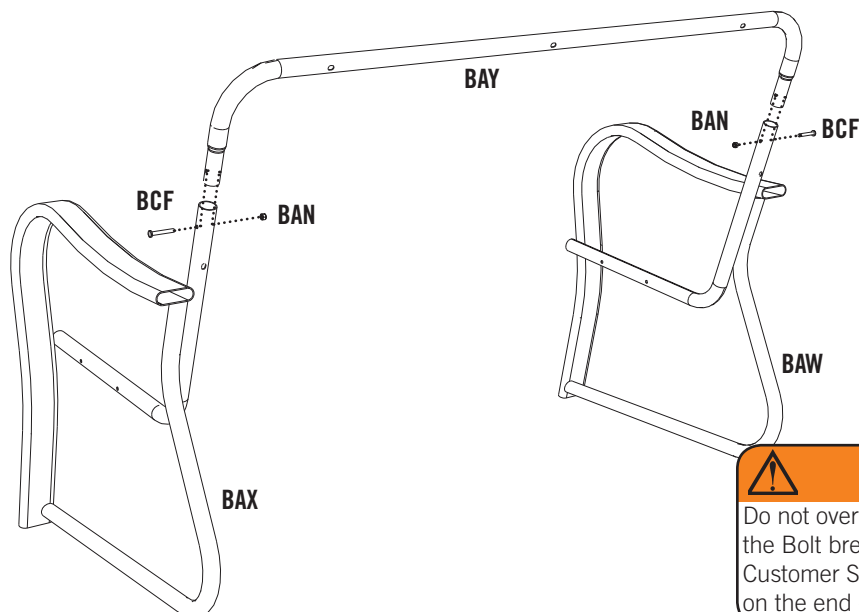

WARNING

Do not overtighten the Cap Nut. If the end of the Bolt breaks through the plastic cap, call our Customer Service Department. Exposed threads on the end of the Bolt may cause serious injuries.



TOOLS AND HARDWARE REQUIRED FOR THIS PAGE

SEC 1

1.

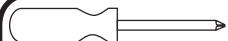

5/16"

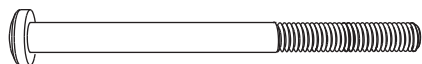

BCG (x4)



BAN (x4)

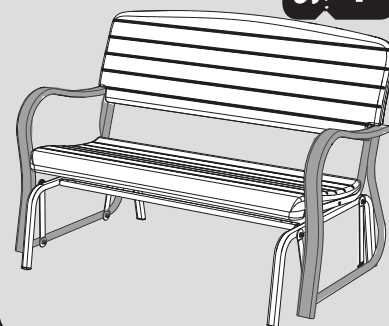
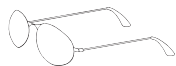

SEC

1.4

Connect the **Seat Cross Support (BAZ)** to the **Right and Left Arms (BAW and BAX)** using the hardware shown.

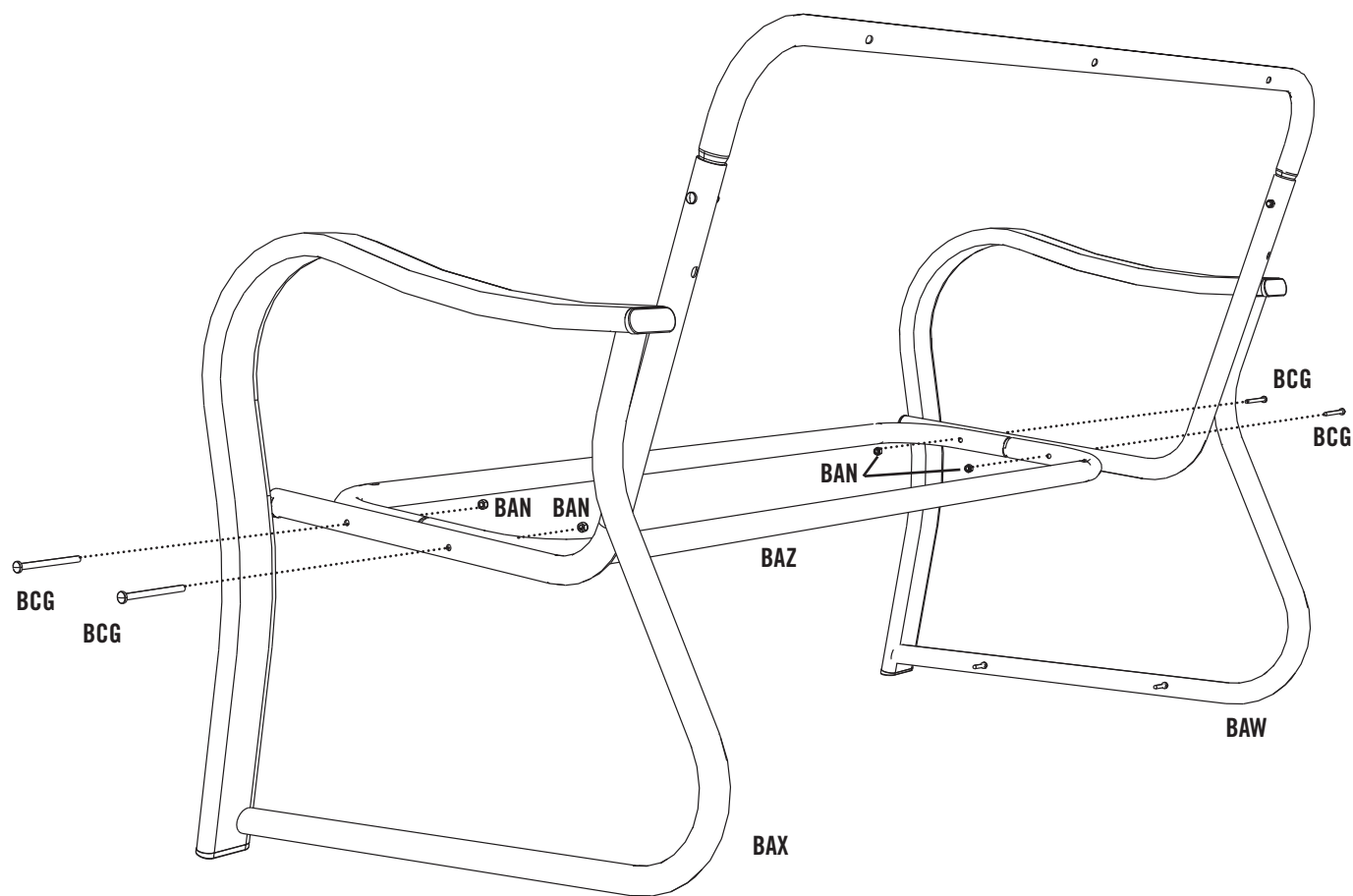

SEC 2 BENCH BACK AND SEAT ASSEMBLY

2.

HARDWARE USED

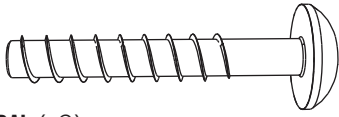

BAL (x9)
Plastic Screw



BAM (x4)
1/4" Nylock Cap Nut

METAL PARTS USED

NO METAL PARTS REQUIRED FOR THIS SECTION

PLASTIC PARTS USED

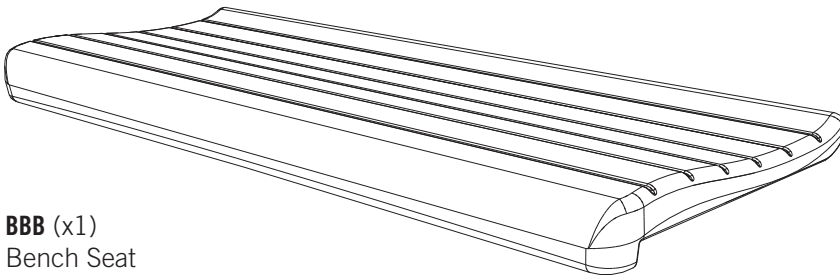

BBB (x1)
Bench Seat

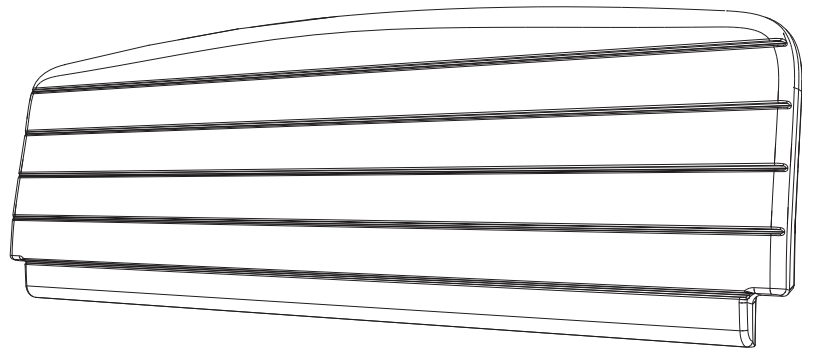

BBA (x1)
Bench Back

TOOLS USED



BAO (x1)
5 mm Allen Wrench (Included)



7/16" Wrench

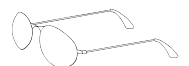

Safety Glasses



TOOLS AND HARDWARE REQUIRED FOR THIS PAGE



BA0
5 mm Allen Wrench (Included)

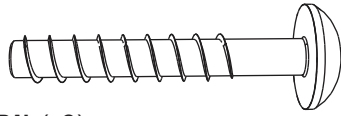
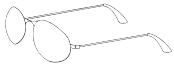

BAL (x9)

SEC 2

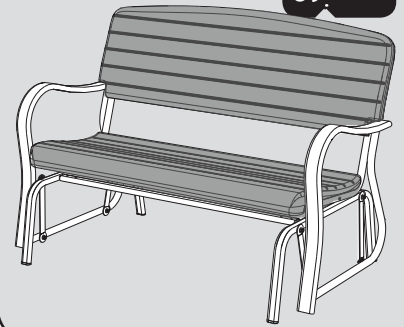

2.

SEC

2.1

BACK AND SEAT ASSEMBLY:

Connect the **Bench Back (BBA)** to the Frame Assembly using the hardware shown.

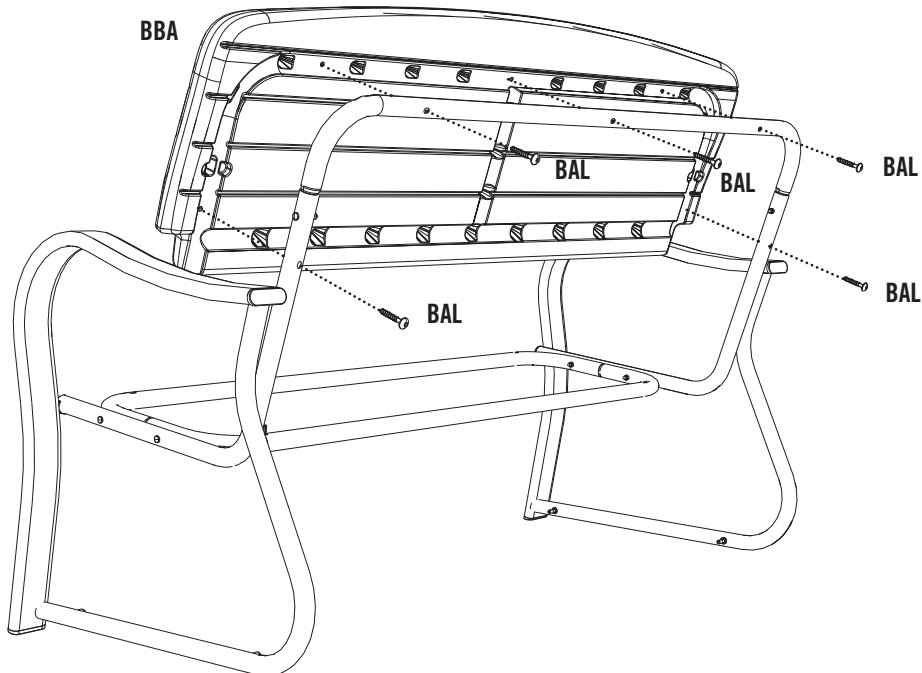

SEC

2.2

Connect the **Bench Seat (BBB)** to the Frame Assembly using the hardware shown.

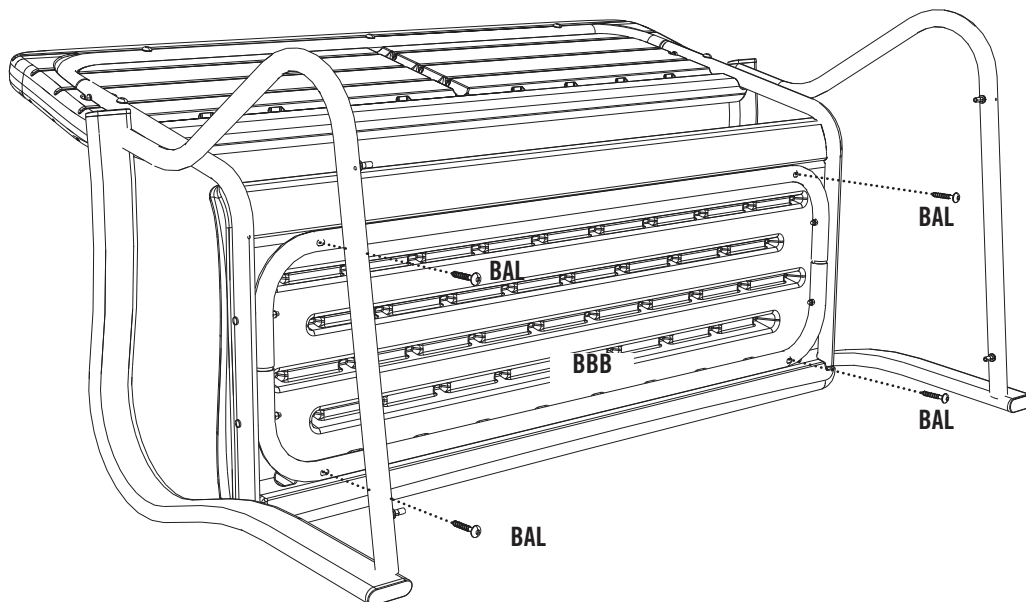



TOOLS AND HARDWARE REQUIRED FOR THIS PAGE

SEC 2



7/16"

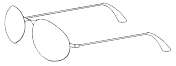

BAM (x4)

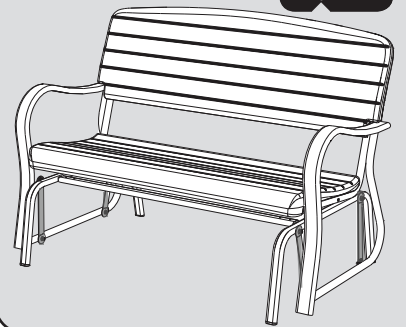

2.

SEC

2.3

Using at least two adults, carefully lift the Upper Bench Assembly and set it on the Leg Assembly.

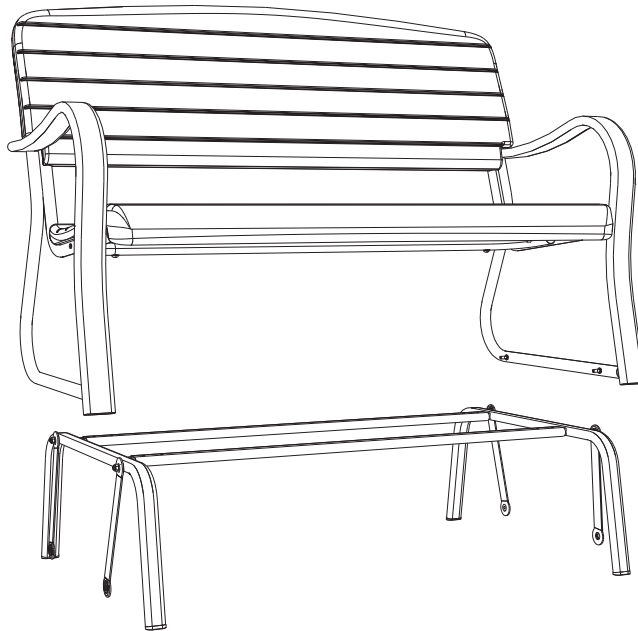

SEC

2.4

Connect Bearing Arms to the Left and Right Leg Assemblies using the hardware shown.

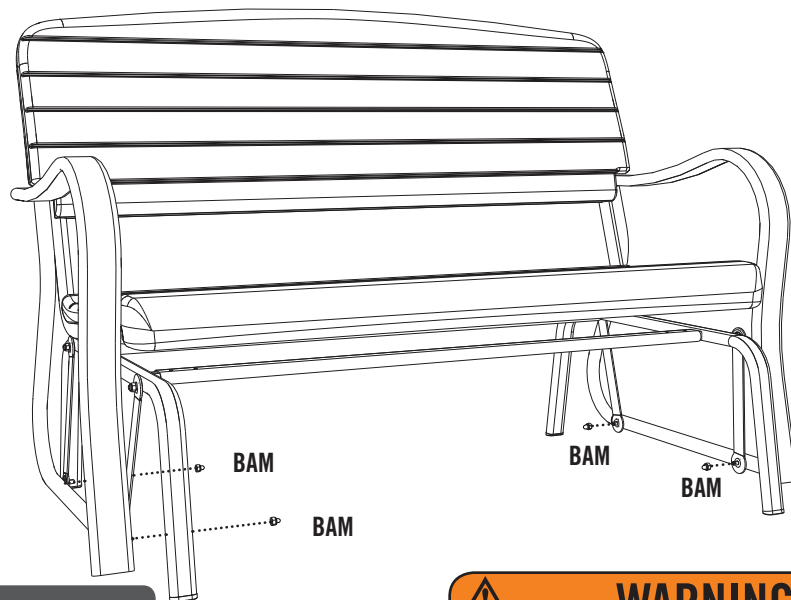

Note: The bearings are lubricated for life and require no further lubrication.



WARNING

Do not overtighten the Cap Nut.

CLEANING AND CARE

Congratulations on your Lifetime purchase. By following the instructions below, your new Lifetime table should provide you with years of service and enjoyment.

CLEANING AND CARE

The polyethylene tabletop and benches are stain- and solvent-resistant. To clean, use a mild soap and a soft-bristled brush. Abrasive cleaning materials may scratch the plastic and are not recommended. Repair scratches or rust spots on the metal frame by sanding the affected area lightly; using a rust-preventative spray primer; and finally, spraying with a high-gloss spray enamel paint. Avoid placing a direct heat source on or near the table surface unless using a heat barrier.



WARNING



ALWAYS KEEP HANDS CLEAR OF MOVING PARTS!

- DO NOT stand on this bench. Using this bench for purposes other than sitting may result in serious personal injuries.
- Two adults are required to move bench. Hold both bench and frame on each end, then lift. Failure to do so could cause serious personal injury.



ADVERTENCIA



¡MANTENGA SUS MANOS LEJOS DE LAS PIEZAS MÓVILES!

- NO SE PARE sobre este asiento. El uso de este asiento para otra finalidad que no sea la de sentarse puede originar graves lesiones personales.
- Se requiere dos personas para mover el banco con seguridad. Sujete el banco y el marco por las extremidades, y levántelo entonces. El incumplimiento de estas instrucciones podría causar graves lesiones personales.



AVERTISSEMENT



IL FAUT TENIR LES MAINS Á DISTANCE DES PIÈCES MOBILES !

- NE PAS se mettre debout sur ce banc. L'utilisation de ce banc pour tout autre usage que pour asseoir peut entraîner des blessures graves.
- Deux adultes sont requis pour déplacer le banc en toute sécurité. Empoignez le banc et le cadre par les extrémités et soulevez. Le non-respect de ces règles peut causer de graves blessures personnelles.



ADVERTÊNCIA



MANTENHA SEMPRE AS MÃOS AFASTADAS DAS PEÇAS EM MOVIMENTO!

- NÃO fique em pé neste banco. O uso deste banco para outros fins que não sejam sentar pode acarretar lesões pessoais graves.
- São necessários dois adultos para movimentar o banco. Segure o banco e a estrutura em cada extremidade, para então levantar. O descumprimento destas instruções pode provocar lesões pessoais graves.

NOTES

NOTES

LIFETIME 2-YEAR LIMITED FACTORY WARRANTY

THE MANUFACTURER RESERVES THE RIGHT TO MAKE SUBSTITUTIONS TO WARRANTY CLAIMS IF PARTS ARE UNAVAILABLE OR OBSOLETE.

1. Lifetime Glider Benches are warranted to the original purchaser to be free from defects in material or workmanship for a period of two years from the date of original retail purchase. The word "defects" is defined as imperfections that impair the use of the product. Defects resulting from misuse, abuse or negligence will void this warranty. This warranty does not cover defects due to alteration or accident. This warranty does not cover damage caused by vandalism, rusting, "acts of nature" or any other event beyond the control of the manufacturer.
 2. This warranty is nontransferable and is expressly limited to the repair or replacement of defective product. If the product is defective within the terms of this warranty, Lifetime Products, Inc. will repair or replace defective parts at no cost to the purchaser. Shipping charges to and from the factory are not covered and are the responsibility of the purchaser.
 3. This warranty does not cover scratching, scuffing or other cosmetic damage that may result from normal use of the product. In addition, defects resulting from intentional damage, negligence or unreasonable use will void this warranty.
 4. Liability for incidental or consequential damages is excluded to the extent permitted by law. While every attempt is made to embody the highest degree of safety in all products, freedom from injury cannot be guaranteed. The user assumes all risk of injury resulting from the use of this product. All merchandise is sold on this condition, and no representative of the company may waive or change this policy.
 5. This warranty is in lieu of all other warranties expressed or implied, including warranties of merchantability or fitness for use. Neither Lifetime Products, Inc. nor any representative assumes any other liability in connection with this product.
-

ALL WARRANTY CLAIMS MUST BE ACCOMPANIED BY A SALES RECEIPT.

REPORT PRODUCT DEFECTS IN WRITING TO:
Lifetime Products, Inc., PO Box 160010 Clearfield, UT 84016-0010
or call (800) 225-3865 M-F 7 a.m. to 5 p.m. MST.

REGISTER YOUR PRODUCT FOR QUICKER CUSTOMER SERVICE.

Visit www.lifetime.com or call (800) 225-3865
to register your product today



©Lifetime Products, Inc.